



# 890 Quickstart Manual

## AC890PX AC Drive

HA471665U000 Issue 2 (ISO A4)  
HA471665U001 Issue 2 (American Quarto)

© Copyright 2008 Parker SSD Drives, a division of Parker Hannifin Ltd.

All rights strictly reserved. No part of this document may be stored in a retrieval system, or transmitted in any form or by any means to persons not employed by a Parker SSD Drives company without written permission from Parker SSD Drives, a division of Parker Hannifin Ltd. Although every effort has been taken to ensure the accuracy of this document it may be necessary, without notice, to make amendments or correct omissions. Parker SSD Drives cannot accept responsibility for damage, injury, or expenses resulting therefrom.

### WARRANTY

Parker SSD Drives warrants the goods against defects in design, materials and workmanship for the period of 12 months from the date of delivery on the terms detailed in Parker SSD Drives Standard Conditions of Sale IA500504.

Parker SSD Drives reserves the right to change the content and product specification without notice.

# Contents

	<i>Page</i>
<b>Safety</b> .....	<b>3</b>
Hazards to Personnel	3
Application Risk	3
• Risk Assessment	4
• Accessibility	4
• Protective Insulation	4
• RCDs	4
<b>Introduction</b> .....	<b>5</b>
About this QuickStart	5
<b>Overview</b> .....	<b>6</b>
• AC890PX (top wire entry)	6
• AC890PX (bottom wire entry)	7
<b>Installation</b> .....	<b>8</b>
Mounting Dimensions	8
Air Flow	8
Environmental Conditions	8
<b>AC890PX Power Connections</b> .....	<b>9</b>
• Components : Top Wire Entry	9
• Wiring Diagram : Top Wire Entry	10
• Components : Bottom Wire Entry	11
• Wiring Diagram : Bottom Wire Entry	12
Auxiliary Transformer Taps (C)	13
<b>AC890PX Control Connections</b> .....	<b>14</b>
<b>AC890PX Feedback Connections</b> .....	<b>14</b>
<b>AC890PX Feedback Connections</b> .....	<b>15</b>
<b>Drive Start-up</b> .....	<b>16</b>
Before Applying Power :	16
<b>Drive Set-up</b> .....	<b>16</b>
Motor Data	16
Quick Setup Parameters	17
Autotune	18
Running in Local	19
Running in Remote	19
<b>Appendix A: Using the 6901 Keypad</b> .....	<b>20</b>
The Menu Structure	21
<b>Appendix B: Analog and Digital I/O</b> .....	<b>22</b>
<b>Appendix C: Electrical Ratings</b> .....	<b>24</b>

# Safety

**IMPORTANT:** Please read this information BEFORE installing the equipment.

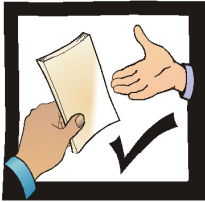

This manual is for anyone installing and operating this unit.



You must be technically competent to install and operate this unit.

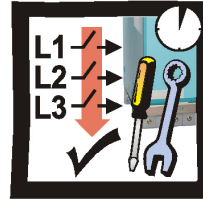

Before working on the unit, isolate the mains supply from terminals L1, L2 and L3 and wait 3 minutes.

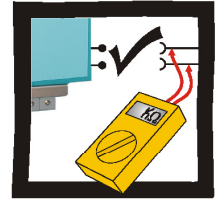

Disconnect the unit from circuits when doing high voltage resistance checks.

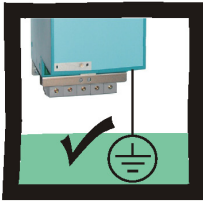

The unit must be **permanently earthed** due to the high earth leakage current.

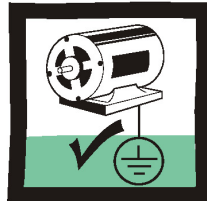

The drive motor must be connected to an appropriate safety earth.



Electrostatic discharge sensitive parts : observe static control precautions.



Copy existing 890 parameters to any replacement 890 unit

## Hazards to Personnel

This equipment can endanger life through rotating machinery and high voltages. Failure to observe the following will constitute an **ELECTRICAL SHOCK HAZARD**.

Metal parts may reach a temperature of 70 degrees Centigrade in operation.

Before working on the equipment, ensure isolation of the mains supply from terminals L1, L2 and L3. Allow at least 10 minutes for the drive's capacitors to discharge to safe voltage levels (<50V). Use the specified meter capable of measuring up to 1000V dc & ac rms to confirm that less than 50V is present between all power terminals and between power terminals and earth.



## Application Risk

The specifications, processes and circuitry described herein are for guidance only and may need to be adapted to the user's specific application.

Parker SSD Drives does not guarantee the suitability of the equipment described in the Manual for individual applications.

---

## Risk Assessment

Under fault conditions, power loss or other operating conditions not intended, the equipment may not operate as specified. In particular:

- The motor speed may not be controlled
- The direction of rotation of the motor may not be controlled
- The motor may be energised

---

## Accessibility

All live power terminals are IP20 rated only, accessible with the enclosure door open.

---

## Protective Insulation

- All control and signal terminals are SELV, i.e. protected by double insulation. Ensure all wiring is rated for the highest system voltage.

**NOTE** *Thermal sensors contained within the motor must be single/basic insulated.*

- All exposed metalwork in the Drive is protected by basic insulation and bonding to a safety earth.

---

## RCDs

Not recommended for use with this product. Where their use is mandatory, use only Type B RCDs (EN61009).

---

## Caution

This is a product of the restricted sales distribution class according to IEC 61800-3. It is designated as “professional equipment” as defined in EN61000-3-2. Permission of the supply authority shall be obtained before connection to the low voltage supply.

---

# Introduction

The AC890PX is designed to control 3-phase induction or permanent magnet AC motors, or to be used as an active front-end.

- Remote control using configurable analogue and digital inputs and outputs.
- Local control using the Keypad.
- Use the Drive System Explorer Configuration Tool (DSE 890) to give access to parameters, diagnostic messages, trip settings and application programming.
- Fit Options to the unit to give serial communications and closed loop speed control.

**IMPORTANT:** *Motors used must be suitable for Inverter duty.*

## About this QuickStart

**This QuickStart will:**

- Familiarise you with the terminals and operation of the unit.
- Provide **basic\*** installation details and a quick set-up procedure.
- Show you how to Autotune the drive and start the motor.

*\* Because the 890 is a system product and we have no knowledge of your application, we detail the quickest way to power-up the drive using a simple earthing scheme with minimal control wiring. Refer to the full Engineering Reference Manual for items not covered in this QuickStart.*

**Provided with every 890 unit is a :**

- Quickstart
- Compact disk containing the Engineering Reference Manual and DSE Lite Configuration Tool
- Keypad
- Customer-ordered Options

**This QuickStart assumes that:**

- You are a qualified technician with experience of installing this type of equipment.
- You are familiar with the relevant standards and Local Electric Codes (which take precedence).
- You have read and understood the Safety information provided at the front of this QuickStart.
- You realise that this guide contains only basic information and that you may need to refer to the Engineering Reference Manual to complete your installation.

# Overview

## AC890PX (top wire entry)

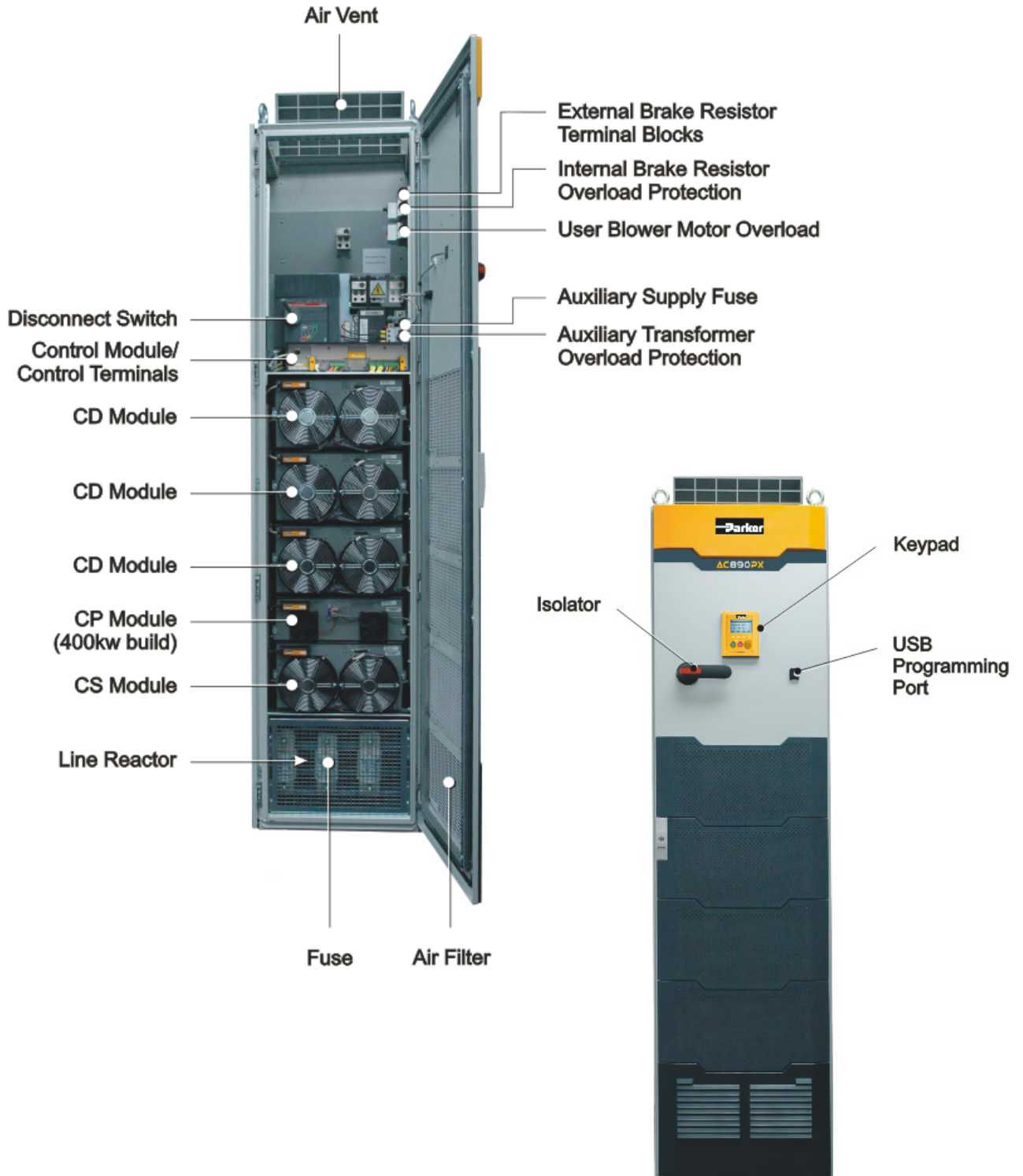

# AC890PX (bottom wire entry)

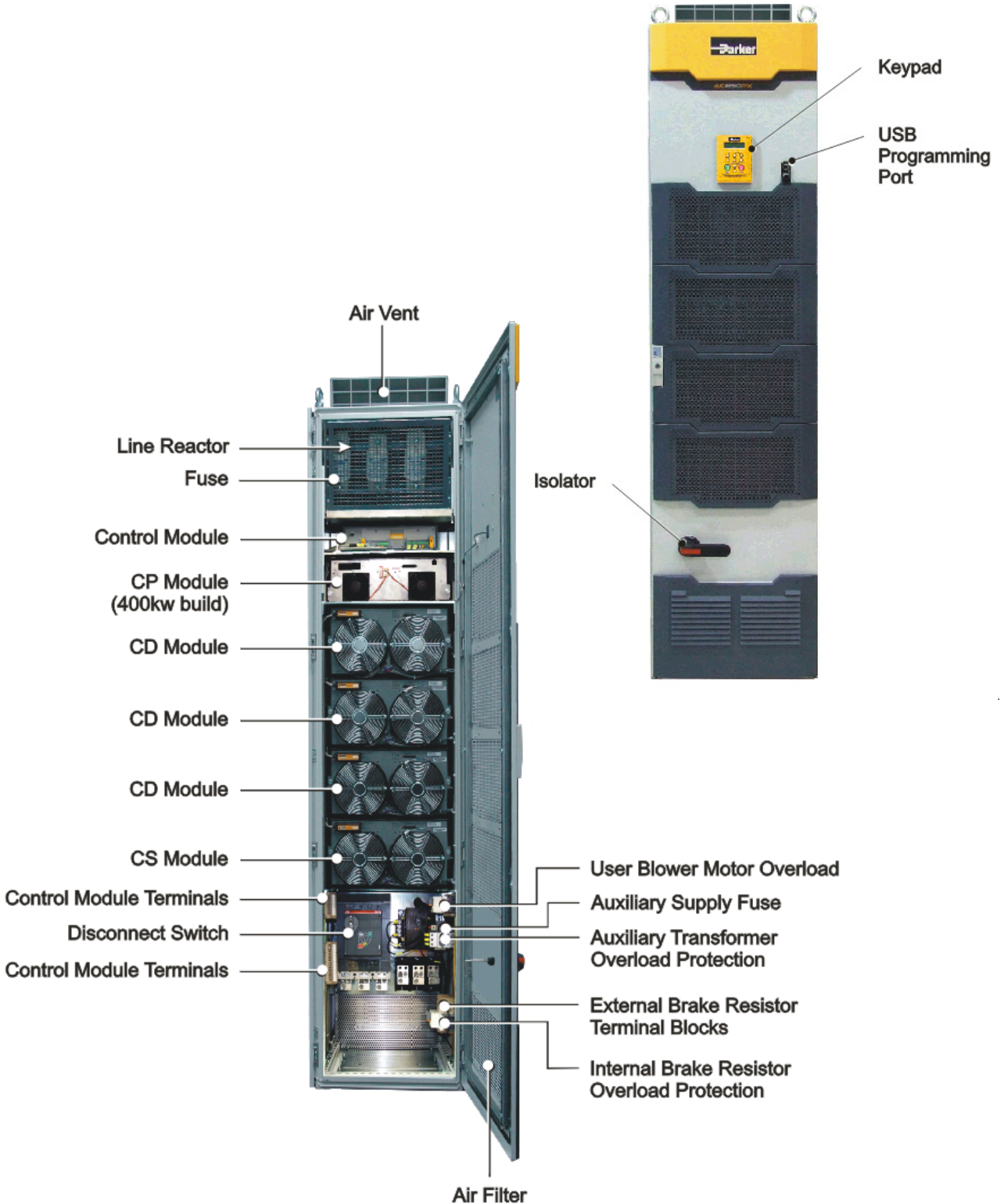

# Installation

For European installations and countries with EMC legislation refer to the 890 Engineering Reference Manual, Appendix C.

## Mounting Dimensions

With any tall unit such as the AC890PX drive, it is advisable to secure the top to prevent it tipping over.

During operation it must stand vertically on a solid, flat, horizontal, normally cool, non-flammable surface.

The bottom wire entry version of the drive will sit on a plinth (allowing the cables to be fed through the bottom of the drive). In this case, also secure the drive to the plinth.

Refer to Chapter 3: Installation Drawings in the Engineering Reference manual for more information.

## Air Flow

It is important that the top vent is properly fitted to assure that the exhaust air is not recirculated.

It is important that air heated by other items should not affect the inlet temperature to the drive's fans.

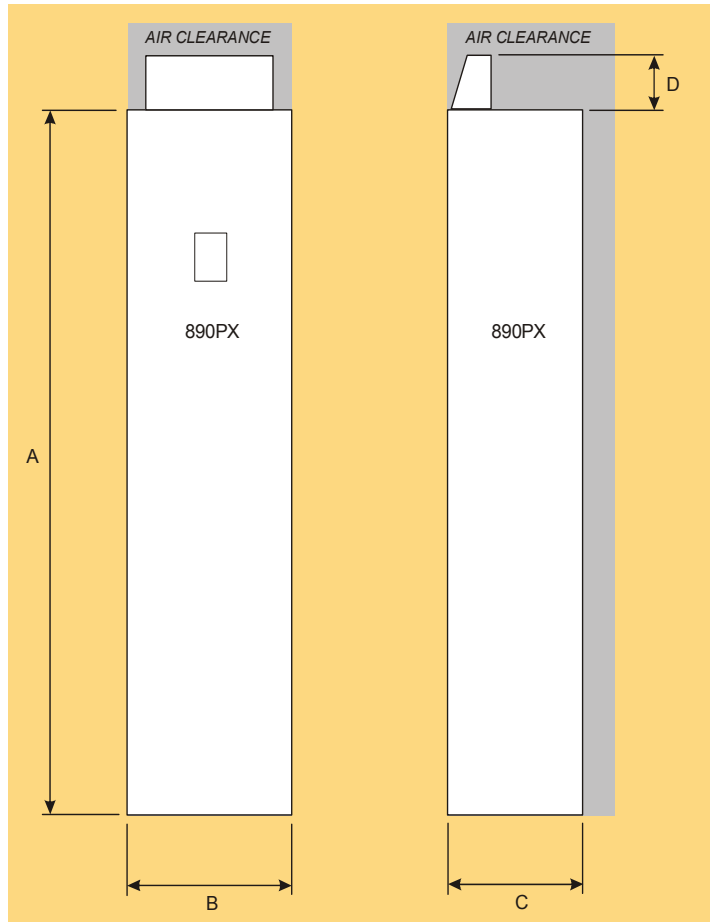

Maximum Weight kg/lbs		A	B	C	D
132kW	600lbs (272kg)	2024mm (79.7")	500mm (19.7")	620mm (24.4")	280mm (11.0")
200kW	600lbs (272kg)				
315kW	732lbs (333kg)				
400kW	790lbs (360kg)				

## Environmental Conditions

Operating ambient temperature

0°C to 40°C (32°F to 104°F)

Enclosure rating

IP4X – UL(cUL) Enclosed Type 1

Atmosphere

Dust free, non flammable, non-corrosive, <85% humidity, non-condensing



# AC890PX Power Connections

## Components : Top Wire Entry

- A** Isolator
- B** Control Module/Control Terminals
- C** Auxiliary Transformer  
**Set the transformer taps - see page 13.**
- D** Motor/Output Connections
- E** Protective Earth/Ground
- F** Internal Brake Resistor Thermal Overload Protection
- G** User Blower Motor Thermal Overload Protection
- H** Auxiliary Supply Protection - Circuit Breaker (primary)
- I** Auxiliary Supply Protection - Semiconductor Fuse (secondary)
- J** External Brake Resistor Terminal Block
- K** 3-Phase Connections



# Wiring Diagram : Top Wire Entry

## Power Connections

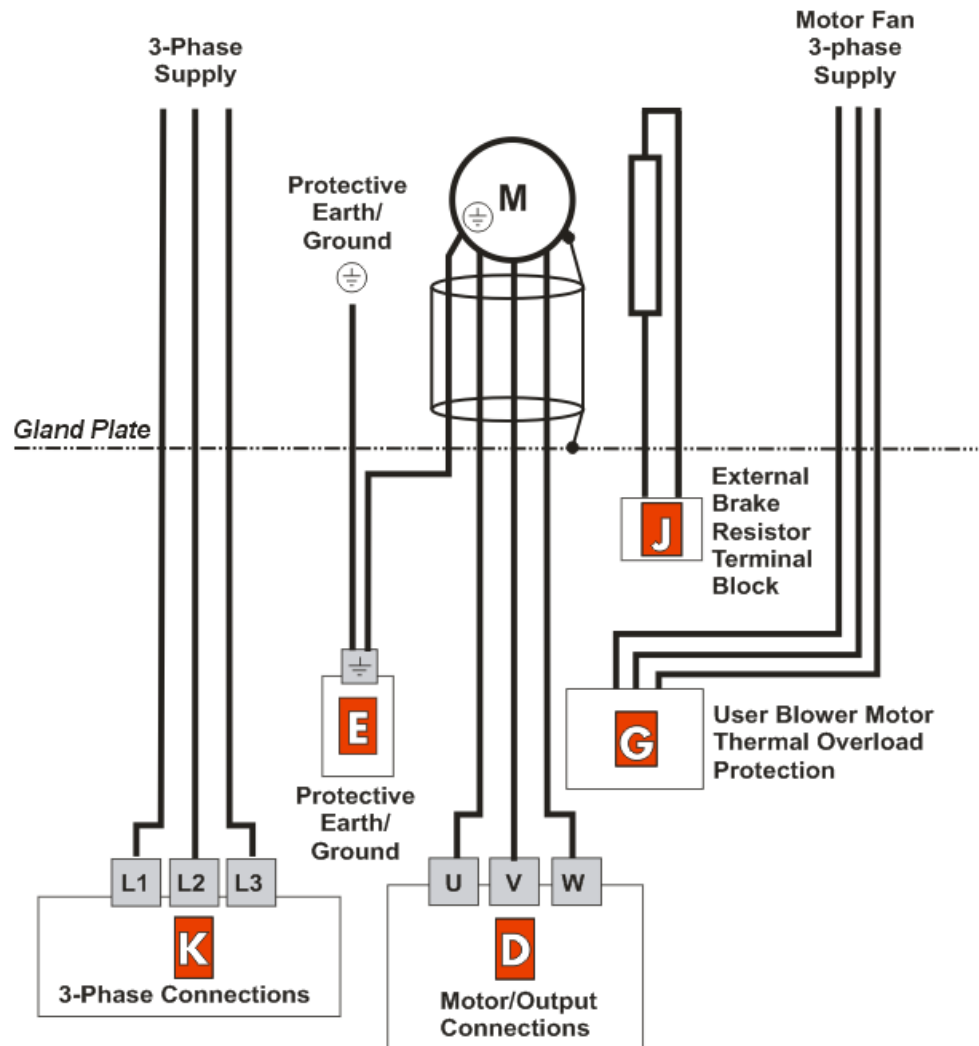

### Permanent Earthing

Each unit must be **permanently earthed** according to EN 61800-5. For permanent earthing, EN 61800-5 states that:

*A cross-section conductor of at least 10mm<sup>2</sup> copper or 16mm<sup>2</sup> aluminium is required.*

**Conductors must be sized in accordance with Local Wiring Regulations which always take precedence.**

As a guide, refer to the Input Current for the drive given in the Electrical Ratings tables.



## Components : Bottom Wire Entry

- A** Isolator
- B** Control Module/Control Terminals
- C** Auxiliary Transformer  
**Set the transformer taps - see page 13.**
- D** Motor/Output Connections
- E** Protective Earth/Ground
- F** Internal Brake Resistor Thermal Overload Protection
- G** User Blower Motor Thermal Overload Protection
- H** Auxiliary Supply Protection - Circuit Breaker (primary)
- I** Auxiliary Supply Protection - Semiconductor Fuse (secondary)
- J** External Brake Resistor Terminal Block
- K** 3-Phase Connections

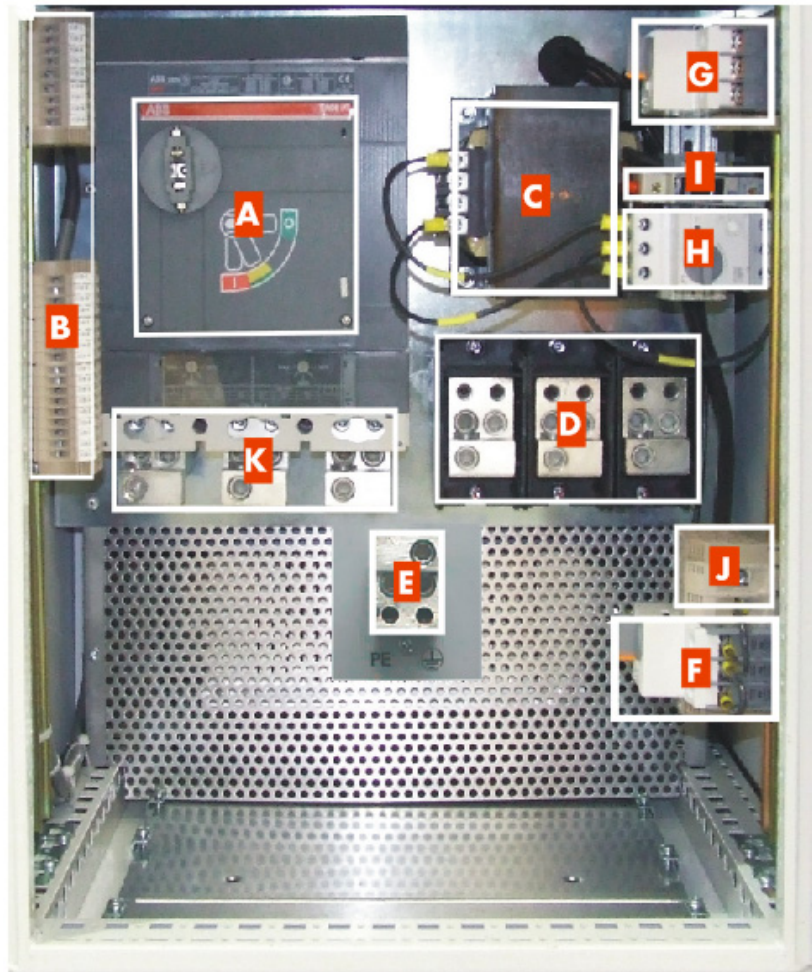
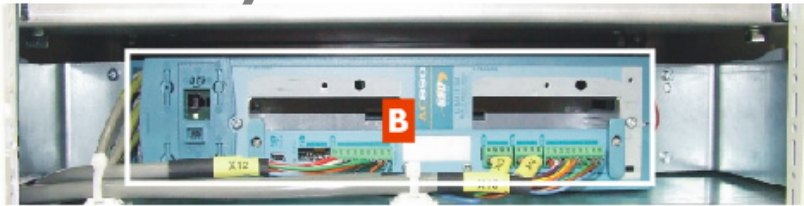

### Permanent Earthing

Each unit must be **permanently earthed** according to EN 61800-5. For permanent earthing, EN 61800-5 states that:

*A cross-section conductor of at least 10mm<sup>2</sup> copper or 16mm<sup>2</sup> aluminium is required.*

**Conductors must be sized in accordance with Local Wiring Regulations which always take precedence.**

As a guide, refer to the Input Current for the drive given in the Electrical Ratings tables.



## Wiring Diagram : Bottom Wire Entry

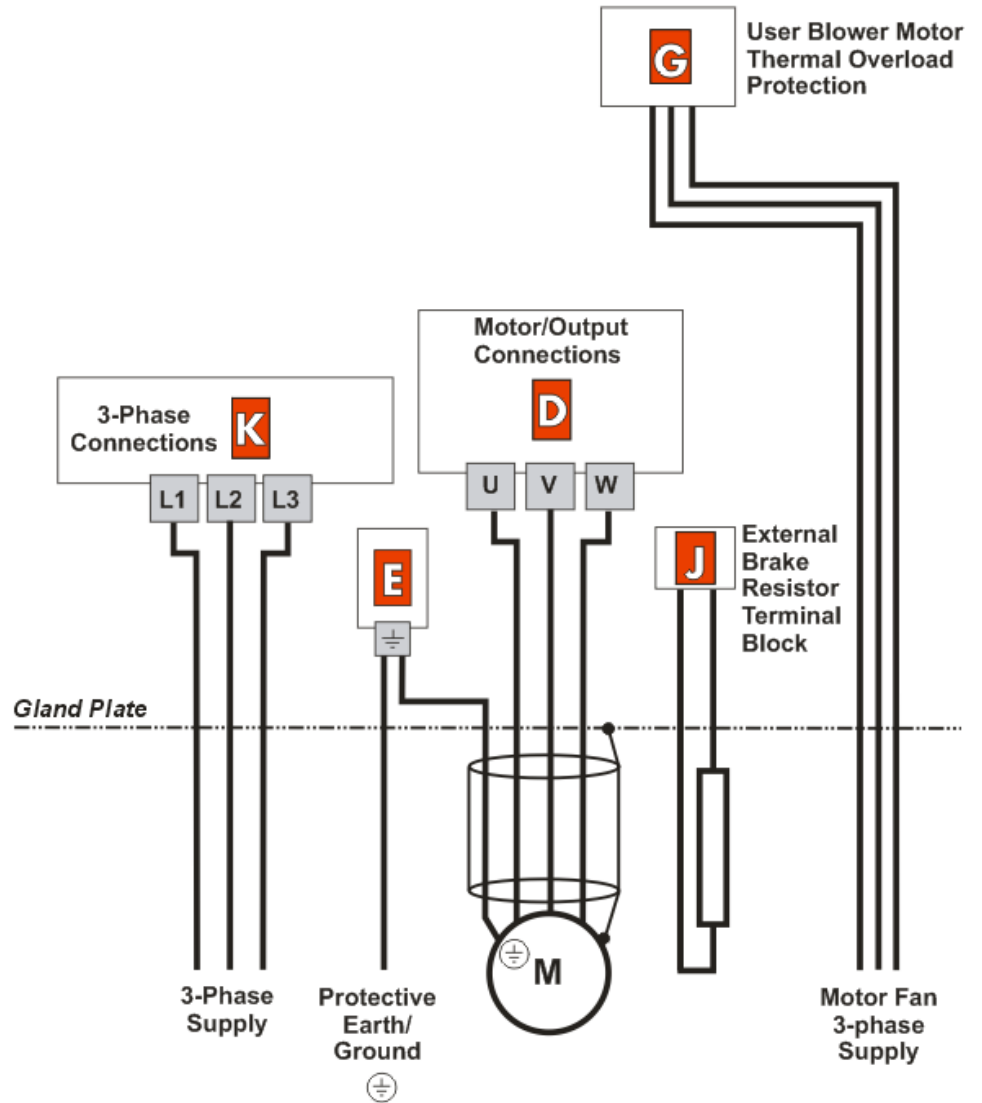

# Auxiliary Transformer Taps (C)

The transformer is tapped for no connection, i.e. 0V - PARK when it leaves the factory and the drive will not operate. Either a low voltage or high voltage transformer option is fitted to the drive.

Match the auxiliary transformer tap to the drive's nominal supply voltage. For example, connect the taps to 0V and 400V for a nominal supply voltage of 400Vac.

The transformer supplies a constant 30Vac to the Control Module, internal fans etc. It is protected by a 40A semi-conductor fuse

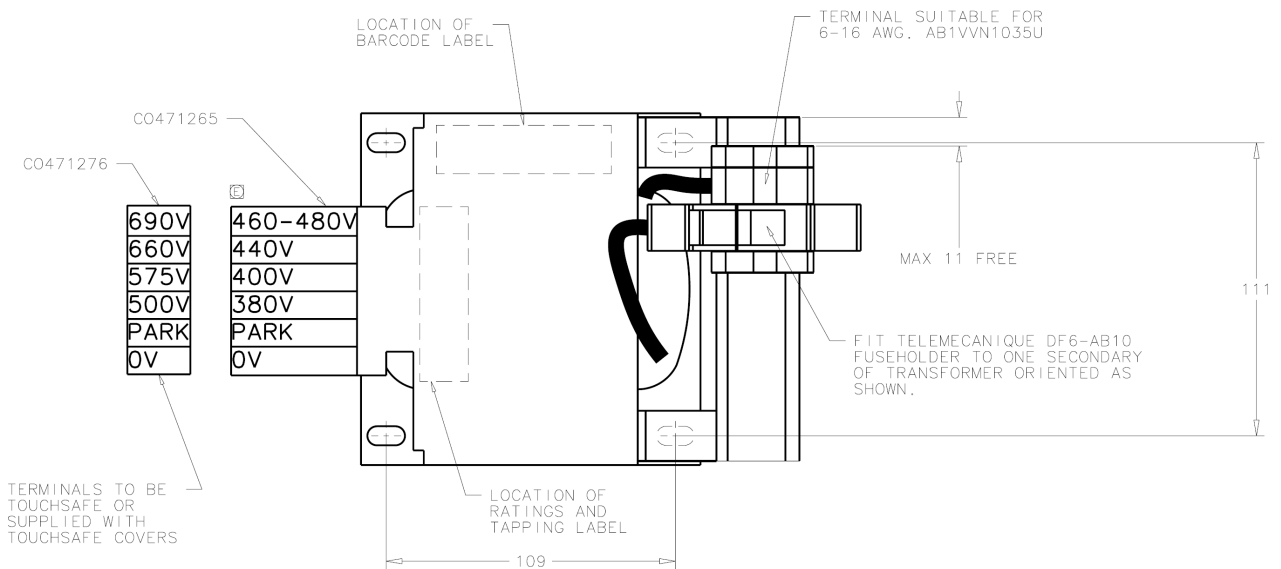
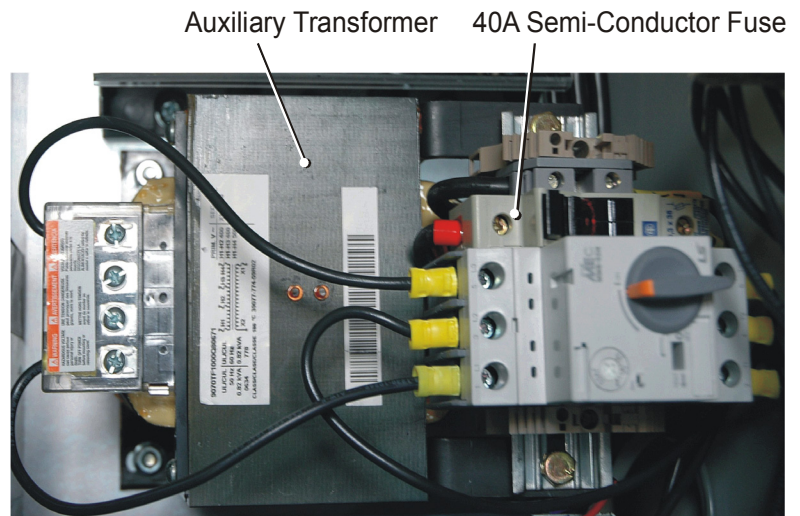



# AC890PX Control Connections

## A Speed Reference

- Connect a 10kΩ potentiometer at terminal block X12 (Analog I/P 3)  
**High (CW):** terminal X12/08  
**Wiper:** terminal X12/04  
**Low (CCW):** terminal X12/01
- Connect the shield to earth/ground on the drive's metal framework.

OR

- External 2-wire speed reference between terminals X12/01(-) and X12/04(+)
- Connect the shield to earth ground on the drive's metal framework.

## B Sequencing

- Connect volt-free contacts as required
- RUN (maintained contact) terminal X14/03 and terminal X15/02

## C Thermistor

- Connect motor thermal switch or thermistor to terminals X16/08 & X16/09. Drive will trip when the thermal switch opens, or when the thermistor resistance exceeds 4kΩ maximum (PTC Type A : IEC 34-11 Part 2)
- If the motor does not have a protective device (thermistor), jumper these terminals. The drive needs the thermistor inputs connected for it to run.

## Analog

- SPEED FEEDBACK**  
10V = ±100% speed at terminal X12/0 6
- TORQUE FEEDBACK**  
10V = ±200% torque at terminal X12/07
- ANALOG COMMON**  
0V at terminal X12/0 1

## Digital

- DRIVE HEALTH**  
Relay dry contact (24V rated) at terminal X14/01 and terminal X14/02
- RUNNING**  
24V sourcing output at terminal X15/08
- ZERO SPEED**  
24V sourcing output at terminal X15/09
- DIGITAL COMMON**  
0V at terminal X14/04

The control terminals will accept a single wire of size 1.5mm<sup>2</sup>/16AWG. For two wires per terminal, use smaller gauge wire such as 0.5mm<sup>2</sup>/22AWG.

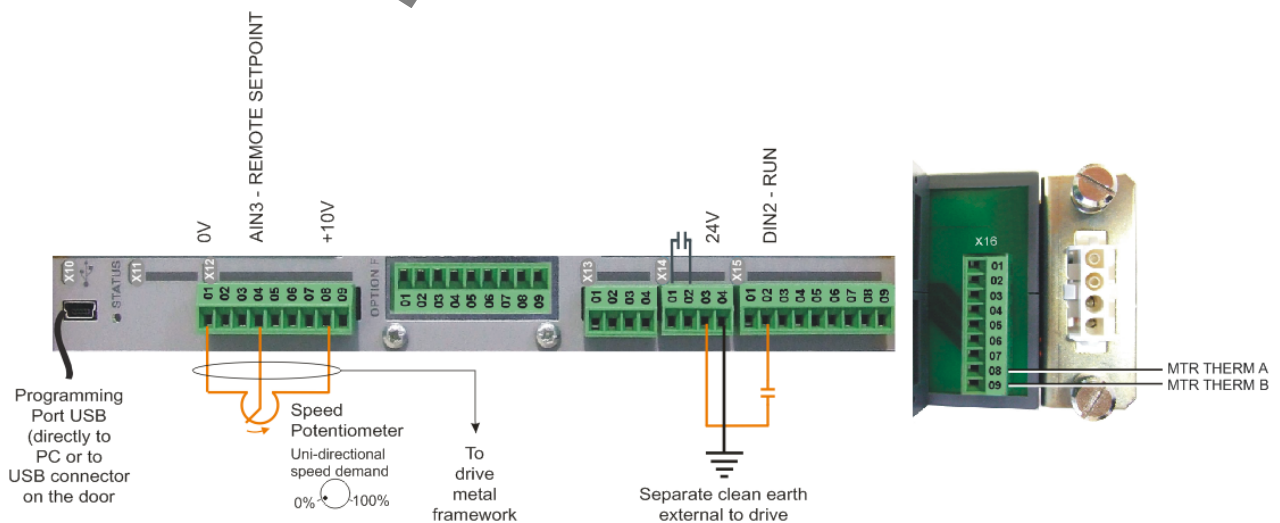

**This is a basic connection diagram.**

For more detailed information on control connections, refer to Appendix B.

# AC890PX Feedback Connections

**This section is only for closed loop vector and induction servo applications. Skip this page if there is no encoder or resolver mounted on the motor.**

## Incremental Pulse Encoders

The default settings for the drive are for 2048 line, quadrature, incremental pulse encoders with differential outputs operating from a 10VDC supply.

- Z channel (Marker pulse) connections are not necessary for running the drive, but inputs are provided for positioning and servo applications. The supply voltage to the encoder is set in the Quick Setup menu. Range 10 VDC to 20 VDC

**Use the Keypad to set the following options:**

Supply Voltage - PULSE ENC VOLTS

Number of lines per revolution - ENCODER LINES parameter

\* Encoder direction - ENCODER INVERT



**OPTION F Terminal Block**

01	Shield
02	Supply -
03	Supply +
04	Channel Z/
05	Channel Z
06	Channel B/
07	Channel B
08	Channel A/
09	Channel A

\* Used to match the encoder direction to the motor direction. When TRUE, changes the sign of the measured speed and the direction of the position count. It is necessary to set up this parameter when in CLOSED-LOOP VEC mode, as the encoder direction must be correct for this mode to operate.

Using other types of encoders requires the 890 DSE Configuration Tool and the setting of other parameters. Refer to the AC890PX Engineering Reference Manual for details of these parameters.

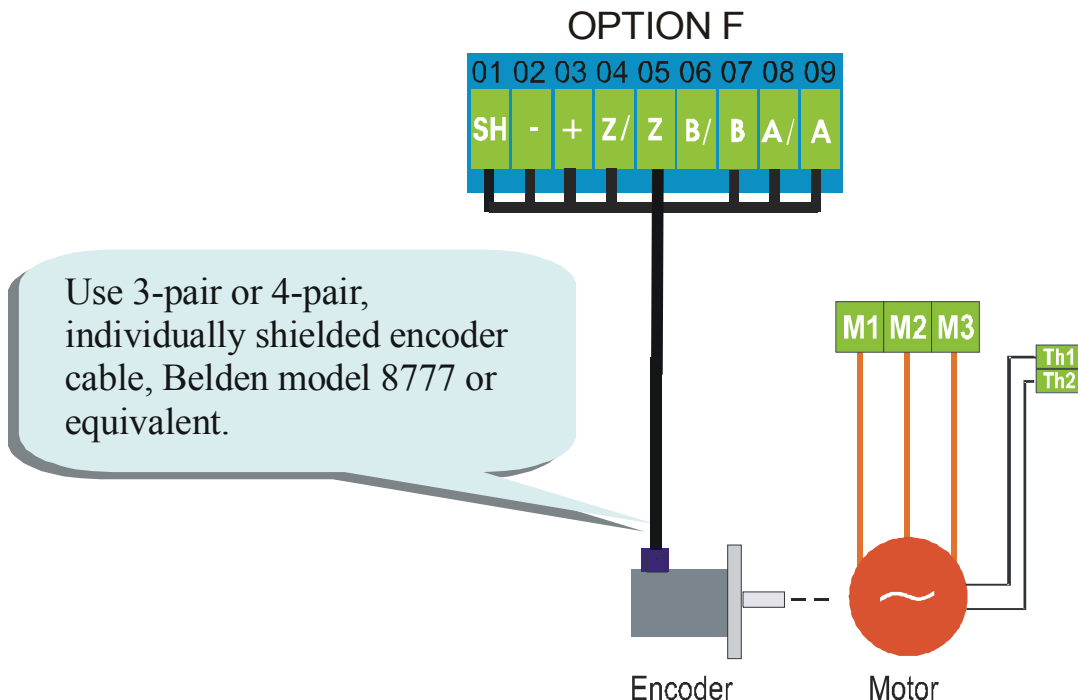

# Drive Start-up

## Before Applying Power :

- Read the Safety section at the front of the QuickStart.
- Ensure that all local electric codes are met.
- Check for damage to equipment.
- Check for loose ends, clippings, filings, drilling swarf etc. lodged in the drive and system.
- Check all external wiring circuits of the system - power, control, motor and earth connections.
- Ensure that unexpected rotation of the motor in either direction will not result in damage, bodily harm or injury. Disconnect the load from the motor shaft, if possible.
- Check the state of the Motor Thermistor and Brake Resistor connectors. Check external run contacts are open. Check external speed setpoints are all at zero.
- Ensure that nobody is working on another part of the system which will be affected by powering up.
- Ensure that other equipment will not be adversely affected by powering up.
- Check motor stator connections are correctly wired for Star or Delta as necessary for drive output voltage.

**If all connections have been checked, it is time to **POWER-UP** the drive**

## Drive Set-up

Appendix A contains information about the Keypad menus and parameter names.

### Motor Data

Before attempting to set up the drive, you will need some motor information. This is found on the motor nameplate. The information you will need is listed below:

- Base Volts
- Base frequency
- Base RPM
- Full load amps
- No load amps (mag current)
- Connection (star or delta)



## Quick Setup Parameters

The following is a list of the Quick Setup parameters you must check before starting the drive. Set only the ones marked with “x” in the table below, under the intended mode of operation.

		<b>V/Hz</b>	<b>SV</b>	<b>Vector</b>	<b>PMAC</b>
Control Mode	Select the intended operating mode	x	x	x	x
Max Speed	Motor RPM at full process speed	x	x	x	x
V/F shape	Usually Linear. Choose fan curve only for fans	x			
Motor Current	Motor full load current from motor nameplate	x	x	x	
Motor Base Freq	Motor nameplate frequency	x	x	x	
Motor Voltage	Motor nameplate voltage	x	x	x	
Nameplate RPM	Motor nameplate RPM	x	x	x	
Motor Poles	See Note		x	x	
Pulse Enc Volts	Set between 10-20V to match encoder			x	
Encoder Lines	Pulses per Revolution of encoder			x	
Encoder Invert	Changes polarity of encoder feedback			x	
Autotune Enable	Drive will Autotune if started		x	x	
Mag Current	Enter the No-Load Amps from the motor nameplate		x*	x*	

- *if performing a Stationary Autotune.*

**NOTE** Some of the parameters are product code dependent, that is, they are different for each frame size and power rating. For example, the unit will be set for either 50Hz or 60Hz operation:

**Motor Poles for 60Hz** 2 poles = 3600 rpm, 4 poles = 1800 rpm, 6 poles = 1200 rpm  
**Motor Poles for 50Hz** 2 poles = 3000 rpm, 4 poles = 1500 rpm, 6 poles = 1000 rpm

# Autotune

**This section is only for operating in Sensorless or Closed-loop Vector modes.  
If the drive is in V/Hz mode, Autotune is unnecessary and will not Enable.**

- Ensure that MAX SPEED is greater than NAMEPLATE RPM for a successful autotune.
- In the QUICK SETUP menu, set AUTOTUNE ENABLE to TRUE.

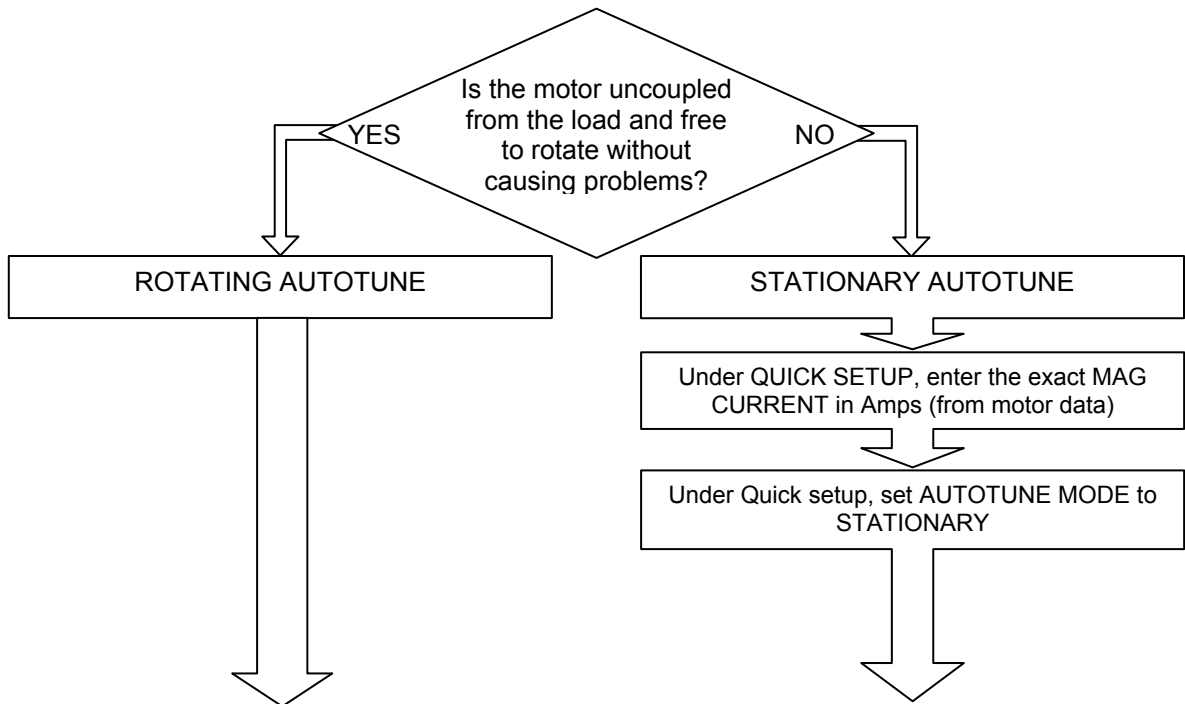

- On the Keypad select LOCAL mode. Set SETPOINT (LOCAL) to 0.0%.
- Press the green RUN button. The drive will begin autotuning. The drive will stop without errors if autotune is successful.
- Go to SYSTEM::SAVE CONFIG::APPLICATION and UP arrow to save your settings.

# Running in Local

- On the Keypad select LOCAL mode. The display will show the Local Setpoint : 0.0%
- Use the UP arrow to set a Local Setpoint, say 20%.
- Press the green RUN button. The motor will accelerate to the desired speed and maintain it. Adjust RAMP ACCEL TIME in Quick Setup to the desired level.
- Press the red STOP button. The motor will decelerate to a stop. Adjust RAMP DECEL TIME in Quick Setup to desired level. If the drive trips on Overvoltage, extend the RAMP DECEL TIME or connect a braking resistor. Refer to the AC890PX Engineering Reference Manual.

Go to SYSTEM::SAVE CONFIG::APPLICATION and UP arrow to save your settings Values are stored during power-down.

# Running in Remote

- On the keypad select REMOTE mode. The display will show the remote Setpoint : ?.?% (The value displayed depends on the external speed reference).
- Dial in a speed setpoint using the Speed potentiometer until the display reads 20%.
- Start the drive by closing the Start contact between terminal X14/03 and terminal X15/02. The motor will accelerate to the desired speed and maintain it. Adjust RAMP ACCEL TIME in Quick Setup to the desired level.
- Open the Start contact. The motor will decelerate to a stop. Adjust RAMP DECEL TIME in Quick Setup to desired level. If the drive trips on Overvoltage, extend the RAMP DECEL TIME or connect a braking resistor. Refer to the AC890PX Engineering Reference Manual..

Go to SYSTEM::SAVE CONFIG::APPLICATION and UP arrow to save your settings Values are stored during power-down.

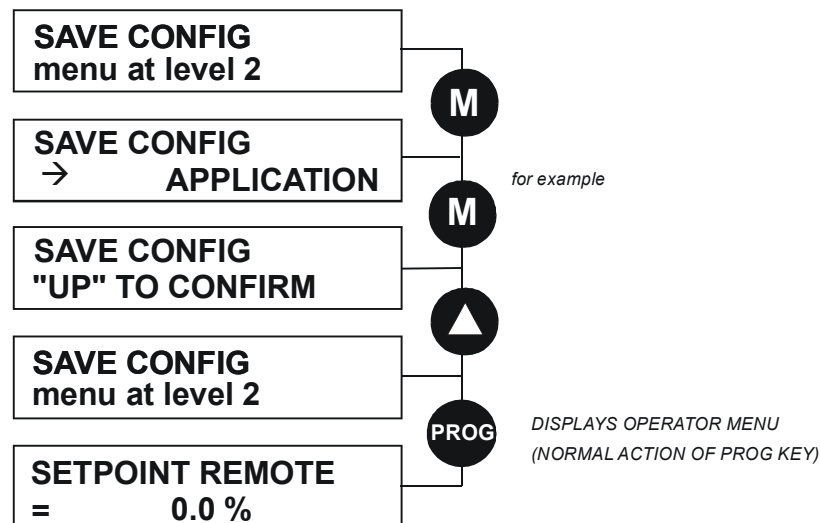

# Appendix A: Using the 6901 Keypad

The 6901 keypad has a two-line backlit LCD display with units and symbols. It can be used to setup and configure the AC890PX in plain language. It can also be used to operate the drive in Local mode from its Start and Stop buttons, Jog and reverse.

**To display the Software Version and Voltage Rating:**

Press **E** repeatedly to display the Welcome Screen

Press **M** to return to the Menus

**To Start in Local Mode:**

Press **I**

**To Stop in Local Mode:**

Press **STOP**



SEQ and REF LEDs are On when in Local mode

<b>Menus :</b>	<b>E</b> exit a menu	<b>M</b> sub-menu or parameter	<b>▲</b> scroll up	<b>▼</b> scroll down
<b>Parameters :</b>	<b>E</b> exit parameter	<b>M</b> make writable	<b>▲</b> previous parameter	<b>▼</b> next parameter
<b>Edit</b>	<b>E</b> stop editing	<b>M</b> show PREF (hold)	<b>▲</b> increment value	<b>▼</b> decrement value

# The Menu Structure

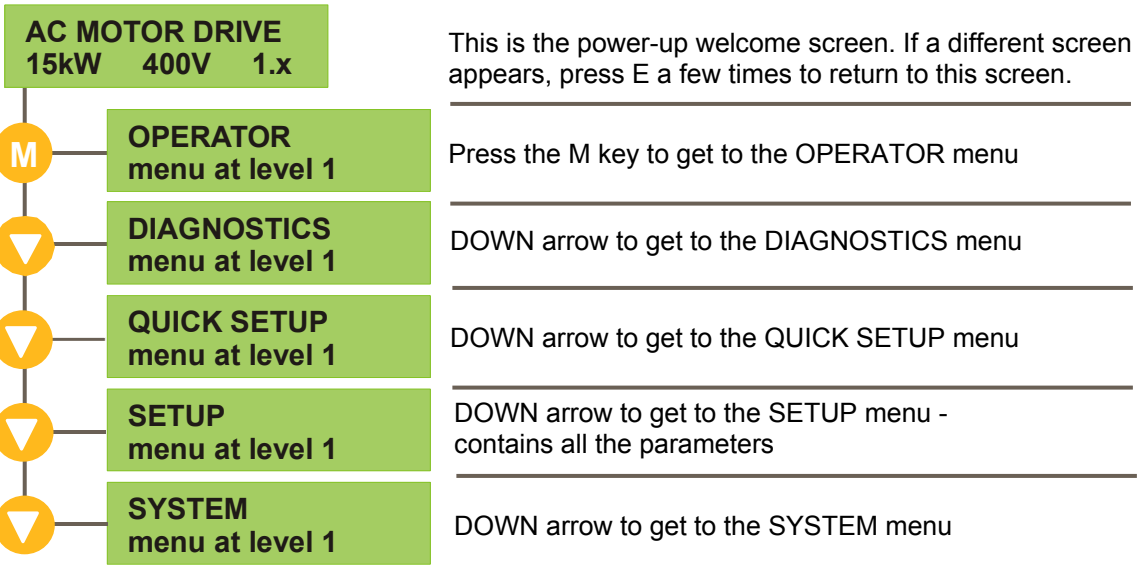

The main menus are shown below. Each menu contains parameters.



**NOTE** Refer to the AC890PX Engineering Reference Manual for a list of available parameters.

### To change Operating Mode:

From power-up, the keypad displays the Software Version, and then times-out to show the Remote Setpoint.

Mode	Action
Remote to Local	Toggle between modes using the L/R key  SEQ and REF LEDs are On when in Local
Local to Remote	Toggle between modes using the L/R key  SEQ and REF LEDs are Off when in Remote

# Appendix B: Analog and Digital I/O

The terminal function names apply to the factory shipping configuration. These terminals may have different functions if the configuration has been modified using DSE.

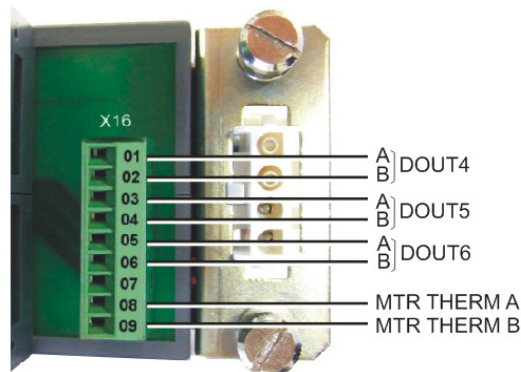
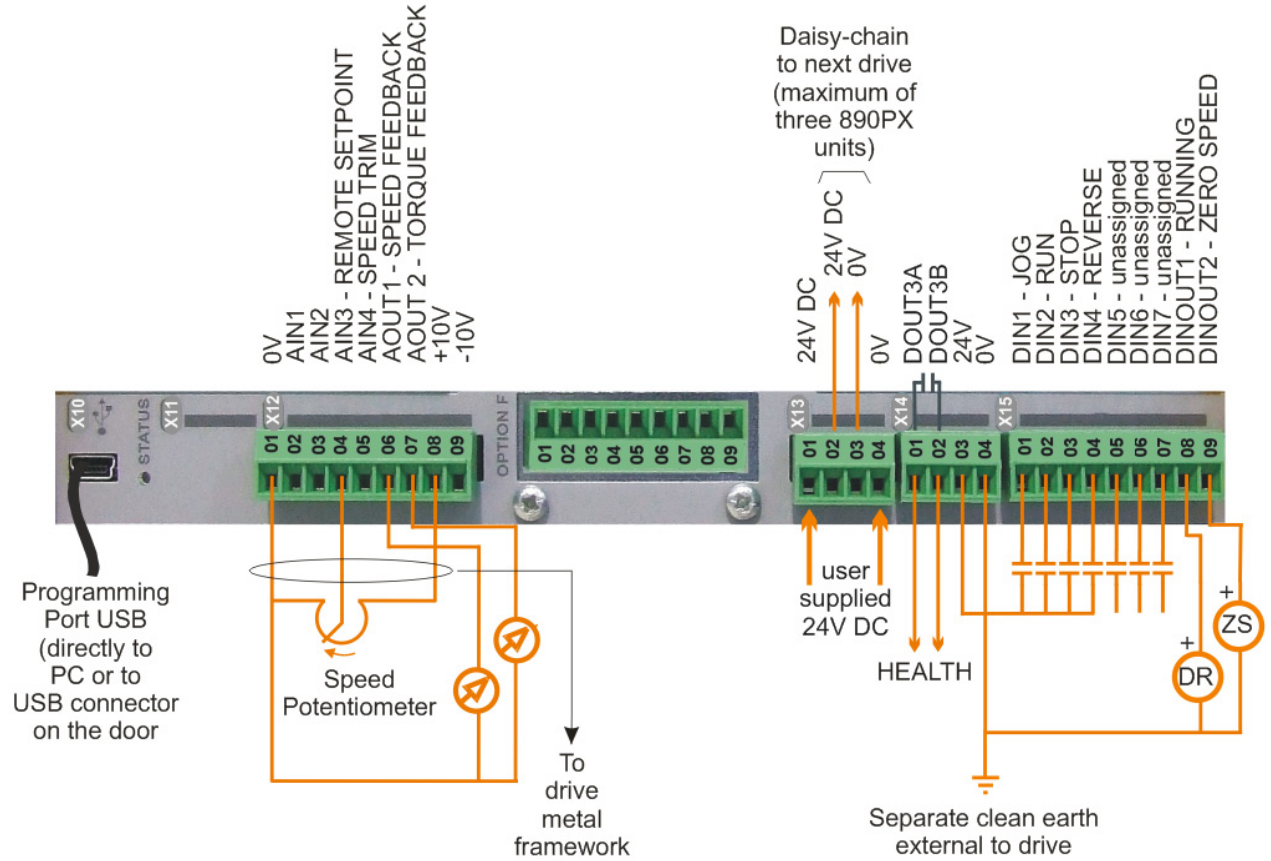

# 890PX Control Terminals

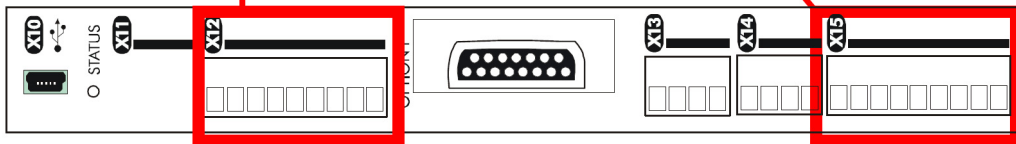

The terminal function names apply to the factory shipping configuration. These terminals may have different functions if the configuration has been modified using DSE.

- Analog I/O connector is X12
- Analog I/O resolution is 12 bit plus sign
- Digital I/O connector is X15
- Digital I/O is 24VDC, sourced, active high

Terminal	Name	Range	Description
<b>ANALOG I/O</b>			
X12/01	0V		0V reference for analog I/O
X12/02	AIN1	0-10V, ±10V	Analog Input 1 Configurable (default = diff I/P +)
X12/03	AIN2	0-10V, ±10V	Analog Input 2 Configurable (default = diff I/P -)
X12/04	AIN3	±10V, 0-10V, 0-20mA, 4-20mA	Analog Input 3 Configurable (default = remote setpoint I/P)
X12/05	AIN4	±10V, 0-10V, 0-20mA, 4-20mA	Analog Input 4 Configurable (default = speed trim I/P)
X12/06	AOUT1	±10V (10V=100%speed)	Analog Output 1 Configurable (default = speed feedback O/P)
X12/07	AOUT2	±10V (10V=200% torque)	Analog Output 2 Configurable (default = torque feedback O/P)
X12/08	+10V REF	+10V	10V reference for analog i/o. Load 10mA maximum
X12/09	-10V REF	-10V	10V reference for analog i/o. Load 10mA maximum
<b>DIGITAL I/O</b>			
X15/01	DIN1	0 or 24V	Configurable Digital Input 1 (default = Jog)
X15/02	DIN2	0 or 24V	Configurable Digital Input 2 (default = Run)
X15/03	DIN3	0 or 24V	Configurable Digital Input 3 (default = Stop)
X15/04	DIN4	0 or 24V	Configurable Digital Input 4 (default = Reverse)
X15/05	DIN5	0 or 24V	Configurable Digital Input 5 (default = Torque mode)
X15/06	DIN6	0 or 24V	Configurable Digital Input 6 (default = Unassigned)
X15/07	DIN7	0 or 24V	Configurable Digital Input 7 (default = Unassigned)
X15/08	DIN8/DOUT1	0 or 24V	Configurable Digital Input/output (default : digital input = Running)
X15/09	DIN9/DOUT2	0 or 24V	Configurable Digital Input/output (default : digital input = Zero Speed)

# Appendix C: Electrical Ratings

## Notes for Electrical Ratings

Read these notes in conjunction with the following ratings tables.

1. **IMPORTANT : The AC890PX is supplied with an in-built Reactor/AC Line Choke providing 3% line impedance.** This is assumed in the quoted input current values.
2.  $\Delta$  input currents given in the table are calculated as:  
 Power Supply:  $\Delta$ , 380-460Vac  $\pm$ 10%, 45-65Hz:  
 400V nominal    400Vac @ 50Hz ac for kW ratings  
                          460Vac @ 60Hz ac for Hp ratings  
  
 Power Supply:  $\Delta$ , 500-575Vac  $\pm$ 10%, 45-65Hz:  
 600V nominal    575Vac @ 60Hz ac for Hp ratings  
                          690Vac @ 50Hz ac for kW ratings  
  
 Power Supply:  $\Delta$ , 600-690Vac  $\pm$ 10%, 45-65Hz:  
 700V nominal    575Vac @ 60Hz ac for Hp ratings  
                          690Vac @ 50Hz ac for kW ratings
3. Maximum Switching Frequency: true value given in the table, note that the MMI will display 3kHz.
4. Heavy Duty : Output Overload Motoring 150% for 60s  
 Normal Duty : Output Overload Motoring 110% for 60s
5. Input Power Factor : 0.94
6. Output Voltage (maximum) = Input Voltage
7. Output Frequency :  
 0-1000Hz : V/Hz mode  
 0-350Hz : closed loop vector mode  
 0-120Hz : sensorless vector mode
8. Fan Inlet Temperature Range : 0-40°C, 32-140°F (drive)
9. Earth Leakage Current :  $\gg$ 100mA.  
 Product must be permanently earthed.
10. Suitable for earth referenced (TN) and non-earth referenced (IT) supplies.
11. Motor power, output current and input current must not be exceeded under steady state operating conditions.
12. Short circuit protection Semiconductor Fuses are installed in the 3-phase supply to the input module to protect the input bridge. Circuit breakers or HRC fuses will not protect the input bridge.
13. The drives have complied with Certification Agencies requirements and the voltage ratings carry the following Safety Marks:  
 380-460V : CE, UL, cUL  
 500-575V : CE, UL, cUL  
 600-690V : CE, (UL - 600V only)



# Electrical Ratings (380-460V)

	Units	890PX/4/0215/	890PX/4/0260/	890PX/4/0300/	890PX/4/0420/	890PX/4/0480/	890PX/4/0520/	890PX/4/0580/
<b>HEAVY DUTY</b>								
Maximum Prospective Short Circuit Current	kA	65	65	65	65	65	65	65
Nominal Input Voltage	V	400	400	400	400	400	400	400
Motor Power	kW	110	132	160	200	250	280	315
Output Current	A	215	260	300	420	480	520	580
AC Input Current	A	194	222	270	340	423	475	534
Drive Total Power Loss	W	2730	3243	3790	4958	5784	6131	6306
Maximum Switching Frequency	kHz	2	2	2	2	2	2	2
Input Bridge I <sup>2</sup> t	A <sup>2</sup> s	245000	245000	245000	1330000	1330000	1330000	1330000
Nominal Input Voltage	V	460	460	460	460	460	-	460
Motor Power	Hp	150	200	250	300	400	-	500
Output Current	A	200	250	300	380	460	-	580
AC Input Current	A	171	218	272	329	436	-	549
Drive Total Power Loss	W	2557	3166	3817	4591	5716	-	6582
Maximum Switching Frequency	kHz	2	2	2	2	2	-	2
Input Bridge I <sup>2</sup> t	A <sup>2</sup> s	235000	235000	235000	1200000	1200000	-	1200000
<b>NORMAL DUTY</b>								
Nominal Input Voltage	V	400	400	400	400	400	400	400
Motor Power	kW	132	160	200	250	315	355	400
Output Current	A	260	340	390	480	600	660	720
AC Input Current	A	228	268	336	423	532	602	679
Drive Total Power Loss	W	3230	4120	4877	5783	7378	7997	8950
Maximum Switching Frequency	kHz	2	2	2	2	2	2	2
Input Bridge I <sup>2</sup> t	A <sup>2</sup> s	245000	245000	245000	1330000	1330000	1330000	1330000
Nominal Input Voltage	V	460	460	460	460	460	-	460
Motor Power	Hp	200	250	300	400	500	-	600
Output Current	A	250	320	380	480	590	-	700
AC Input Current	A	222	242	326	436	547	-	659
Drive Total Power Loss	W	3148	3870	4771	5879	7417	-	8894
Maximum Switching Frequency	kHz	2	2	2	2	2	-	2
Input Bridge I <sup>2</sup> t	A <sup>2</sup> s	235000	235000	235000	1200000	1200000	-	1200000

# Electrical Ratings (500-575V & 600-690V)

	Units	890PX/6/130/ 890PX/7/0130/	890PX/6/0160 890PX/7/0160	890PX/6/0190 890PX/7/0190	890PX/6/0230 890PX/7/0230	890PX/6/0280 890PX/7/0280	890PX/6/0320 890PX/7/0320	890PX/6/0340 890PX/7/0340
<b>HEAVY DUTY</b>								
Maximum Prospective Short Circuit Current	kA	65	65	65	65	65	65	65
Nominal Input Voltage	V	690	690	690	690	690	690	690
Motor Power	kW	110	132	160	200	250	280	315
Output Current	A	130	160	190	230	280	320	340
AC Input Current	A	134	154	177	198	244	277	309
Drive Total Power Loss	W	2398	2869	3279	3945	4629	5411	5795
Maximum Switching Frequency	kHz	2	2	2	2	2	2	2
Input Bridge I <sup>2</sup> t	A <sup>2</sup> s	245000	245000	245000	720000	720000	720000	720000
Nominal Input Voltage	V	575	575	575	-	575	-	575
Motor Power	Hp	150	200	250	-	300	-	400
Output Current	A	160	210	260	-	310	-	410
AC Input Current	A	144	180	221	-	259	-	347
Drive Total Power Loss	W	2857	3510	4456	-	4888	-	6432
Maximum Switching Frequency	kHz	2	2	2	-	2	-	2
Input Bridge I <sup>2</sup> t	A <sup>2</sup> s	235000	235000	235000	-	820000	-	820000
<b>NORMAL DUTY</b>								
Nominal Input Voltage	V	690	690	690	690	690	690	690
Motor Power	kW	132	160	200	250	315	355	400
Output Current	A	160	190	240	280	340	390	430
AC Input Current	A	157	177	210	244	305	347	389
Drive Total Power Loss	W	2717	3206	4213	4753	5777	6613	7333
Maximum Switching Frequency	kHz	2	2	2	2	2	2	2
Input Bridge I <sup>2</sup> t	A <sup>2</sup> s	245000	245000	245000	720000	720000	720000	720000
Nominal Input Voltage	V	575	575	575	-	575	-	575
Motor Power	Hp	200	250	300	-	400	-	500
Output Current	A	210	250	310	-	420	-	480
AC Input Current	A	182	180	264	-	344	-	432
Drive Total Power Loss	W	3634	4059	5285	-	6582	-	7648
Maximum Switching Frequency	kHz	2	2	2	-	2	-	2
Input Bridge I <sup>2</sup> t	A <sup>2</sup> s	235000	235000	235000	-	820000	-	820000