

6053/6055

Ethernet Communications

Interface

Technical Manual

HA468030U001 Issue 3

Compatible with Version 1.x Software

© Copyright 2007 Parker SSD Drives, a division of Parker Hannifin Ltd.

All rights strictly reserved. No part of this document may be stored in a retrieval system, or transmitted in any form or by any means to persons not employed by a Parker SSD Drives company without written permission from Parker SSD Drives, a division of Parker Hannifin Ltd. Although every effort has been taken to ensure the accuracy of this document it may be necessary, without notice, to make amendments or correct omissions. Parker SSD Drives cannot accept responsibility for damage, injury, or expenses resulting therefrom.

WARRANTY

Parker SSD Drives warrants the goods against defects in design, materials and workmanship for the period of 12 months from the date of delivery on the terms detailed in Parker SSD Drives Standard Conditions of Sale IA058393C.

Parker SSD Drives reserves the right to change the content and product specification without notice.

Safety Information



WARNING!

During commissioning, remove the fuses (or trip the circuit breaker) on your 3-phase supply.
Make sure the power is OFF, and that it cannot be switched on accidentally whilst you are working.

REFER TO YOUR MAIN PRODUCT MANUAL FOR SPECIFIC SAFETY INFORMATION ABOUT THE DEVICE YOU ARE CONTROLLING

IMPORTANT: Please read this information BEFORE installing the equipment.

Intended Users

This manual is to be made available to all persons who are required to install, configure or service equipment described herein, or any other associated operation.

The information given is intended to highlight safety issues, EMC considerations, and to enable the user to obtain maximum benefit from the equipment.

Application Area

The equipment described is intended for industrial motor speed control.

Personnel

Installation, operation and maintenance of the equipment should be carried out by qualified personnel. A qualified person is someone who is technically competent and familiar with all safety information and established safety practices; with the installation process, operation and maintenance of this equipment; and with all the hazards involved.

Safety

All control and signal terminals are SELV, i.e. protected by double insulation.

EMC

In a domestic environment this product may cause radio interference in which case the user may be required to take adequate counter-measures.

This equipment contains electrostatic discharge (ESD) sensitive parts. Observe static control precautions when handling, installing and servicing this product.

Safety Information



CAUTION!

At any time, there may be a loss of motor control and separate/independent application measures should be taken to ensure that such loss of motor control cannot present a safety hazard.

RISK ASSESSMENT

Under fault conditions, power loss or unintended operating conditions, the drive may not operate as intended. In particular:

- Stored energy might not discharge to safe levels as quickly as suggested, and can still be present even though the drive appears to be switched off
- The motor's direction of rotation might not be controlled
- The motor speed might not be controlled
- The motor might be energised

A drive is a component within a drive system that may influence its operation or effects under a fault condition. Consideration must be given to:

- Stored energy
- Supply disconnects
- Sequencing logic
- Unintended operation

Contents

Contents

Page

| | |
|--|-----------|
| ETHERNET TECHNOLOGY OPTION | 1 |
| System Overview | 1 |
| Product Features | 1 |
| Product Code and Contents | 1 |
| CELite Requirements | 1 |
| Hardware Installation | 1 |
| Installing and Connecting the Ethernet Technology Option | 1 |
| Connection Diagram | 3 |
| Understanding the LED Indications | 4 |
| Initial Power-on Checks | 4 |
| Configuring the Drive | 5 |
| • The Ethernet MMI View | 5 |
| • The Non-specific ConfigEd-Lite & MMI View | 5 |
| • Parameter Descriptions | 6 |
| Commissioning the Ethernet Technology Option | 7 |
| Configuring the IP address | 7 |
| • 590 + Point to Point I/O | 9 |
| • 690+ Point to Point I/O Connection | 11 |
| Configuring the PLC/SCADA Supervisor | 13 |
| • Modicon Momentum | 13 |
| • Allen Bradley ControlLogix | 15 |
| Appendix A: Ethernet Error Codes | 18 |
| Appendix B: Troubleshooting | 25 |
| • 6053/6055 Ethernet Technology Option Status LED | 25 |
| Returning the Unit to Parker SSD Drives | 26 |
| Disposal | 26 |
| Appendix C: External Control of the Drive | 27 |
| • 590+ | 27 |
| • 690+ | 30 |
| Appendix D Sample Configurations | 34 |

ETHERNET TECHNOLOGY OPTION

System Overview

Product Features

- Compact: 127mm (5) H x 76.2mm (3) W x 25.4mm (1) D - (inches)
- Plug-in installation to drive
- Suitable for use with drive models:
 - 590+ software version >7.1; 690+ software version >4.7
- Connection using serial cable (shielded twisted pair)
- LED's to indicate board and communications status
- 10 / 100 M bits/s
- Default Slave Address allows switch selectable I/P address.
- Slave Address can be set using MicroSoft Internet Explorer.
- Supported protocols ModBus/TCP and Ethernet/IP

Product Code and Contents

The Parker SSD Drives' product is fully identified using an alphanumeric code which records how the product was assembled, and its various settings when despatched from the factory.

The Technology Option can be supplied with the drive product, or supplied separately:

| Product | Product Code when supplied with the Drive | Product Code when supplied separately |
|---------|--|---------------------------------------|
| 690+B | 690PB/xxxx/xxx/x/x/xxxx/xxxx/xxxx/ETH/xxxx/xxxx/xxxx | 6053/ETH/00 - plug-in Technology Box |
| 690+C-J | 690P/xxxx/xxx/xxxx/xx/xxx/ ETH /xxx/xxx/xx/xxx/xxx | 6055/ETH /00 - plug-in Technology Box |
| 590+ | 590P/xxxx/xxx/xxxx/xx/xxx/ ETH /xxx/xxx | 6055/ETH /00 - plug-in Technology Box |
| 591P | 591P/xxxx/xxx/xxxx/xx/xxx/ ETH /xxx/xxx | 6055/ETH /00 - plug-in Technology Box |

CELite Requirements

Software version: 5.17 or higher.

Hardware Installation

Installing and Connecting the Ethernet Technology Option

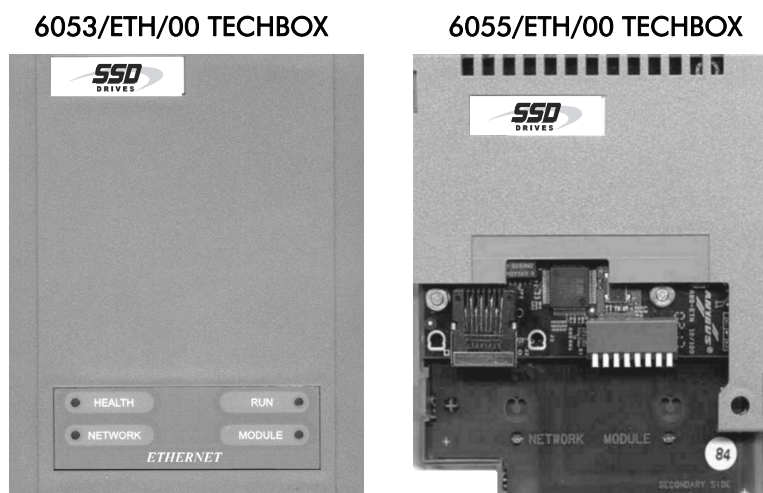

Figure 1. The Ethernet Technology Options

WARNING!

Prior to starting work ensure all sources of power are isolated.

The Ethernet Technology Option plugs into the drive in the slot provided.

Frame B

Fit the Technology Option in place of the Keypad. Connect the supplied yellow/green wire between the Technology Option's metal case and one of the chassis earth pillars. Fit a 6052 Remote Mounting Kit to use the keypad with the drive while the Technology Option is installed. Refer to Figure 2.

Frames C - J

Fit the Technology Option in the right-hand "Comms Option" position. Refer to Figure 3.

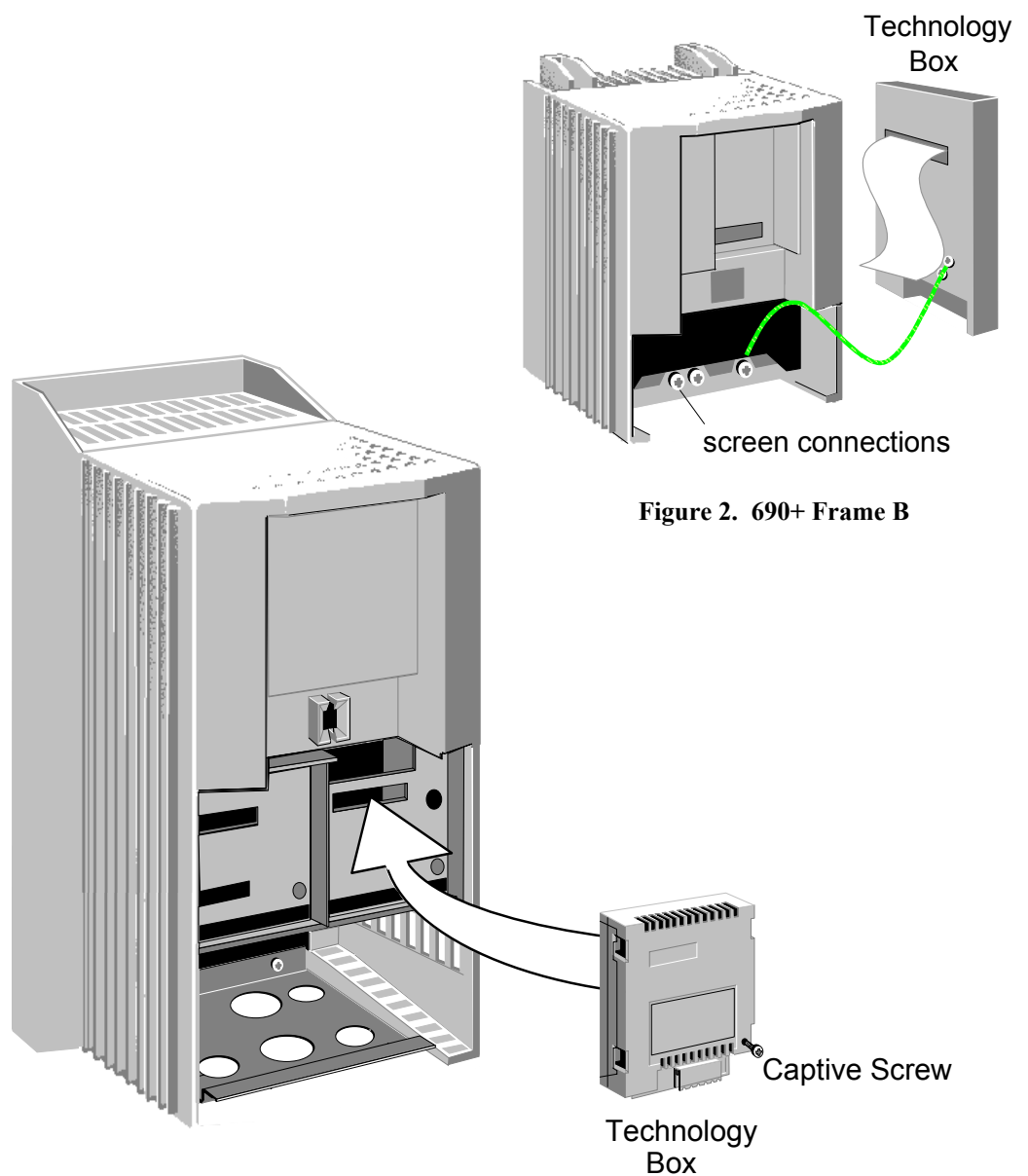

Connection Diagram

WARNING!

Before installing, ensure that the drive wiring is electrically isolated and cannot be made "live" unintentionally by other personnel.
Wait 5 minutes after disconnecting power before working on any part of the system or removing the covers from the drive.

Connection to the drive(s) from a PC, or PLC for example, is made using a cable fitted with standard RJ45 connectors at both ends. The cable plugs into the PLC, for example, and into the socket on the Ethernet techbox.

Note: When connecting to one drive direct from PC/PLC, you must use a crossover cable.

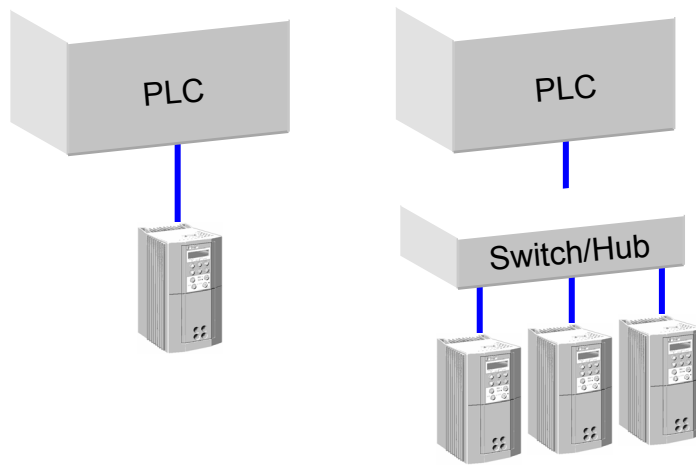

RJ45 (Standard) Pin Details

| Pin | Signal |
|-----|-------------|
| 1 | TD+ |
| 2 | TD- |
| 3 | RD+ |
| 4 | Termination |
| 5 | Termination |
| 6 | RD- |
| 7 | Termination |
| 8 | Termination |

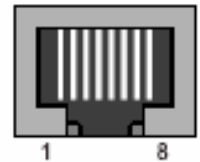

Cable Specifications

| Cable Type | Maximum Node-to-Node Distance (m) |
|------------|-----------------------------------|
| CAT5 | 100 |
| CAT5E | 100 |

4

Understanding the LED Indications











| Network LED | | | Module LED | | |
|---|---|---------------------|--|---|-----------------|
| Indicates the state of the connected network. The states indicated are those produced by the NET STATE parameter of the TEC OPTION function block. | | | Indicates the set-up state of the Technology Option. The states indicated are those produced by the FAULT parameter of the TEC OPTION function block. | | |
| Network LED Indication | | NET STATE Parameter | Module LED Indication | | FAULT Parameter |
| ON  | 0 | CONNECTED | ON  | 0 | NONE |
| LONG FLASH  | 1 | reserved | LONG FLASH  | 1 | PARAMETER |
| FLASH  | 2 | reserved | FLASH  | 2 | TYPE MISMATCH |
| SHORT FLASH  | 3 | NOT CONNECTED | SHORT FLASH  | 3 | SELF TEST |
| OFF  | 4 | DISABLED | OFF  | 4 | HARDWARE |
| | 5 | INITIALISING | | | |

Figure 4. LED Status Indication

Note: The NETWORK LED is always in the OFF State when the MODULE LED is not ON.

Initial Power-on Checks

With the TechBox correctly fitted and configured the MODULE LED will be ON continuously and the NETWORK LED will flash to indicate the Not Connected state.

Configuring the Drive

Begin by configuring the drive to accept the Technology Option. Use the keypad (MMI), or ConfigEd Lite to configure the TEC OPTION function block parameters inside the drive before commissioning the Ethernet technology option.

The parameter names and functions in this function block are inter-dependent and will change with different parameter values and various Options that can be fitted.

Fit the Ethernet option to the drive:

- Navigate to the VIEW LEVEL parameter and select ADVANCED. This allows you to view the SETUP PARAMETERS menu.
- In the SETUP PARAMETERS menu, navigate to the TEC OPTION menu and set the TYPE parameter to "ETHERNET".

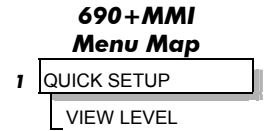

Note: When using the MMI, remember to save the set-up via the Parameter Save or Config Save menu.

The Ethernet MMI View

With the Ethernet option correctly installed, the TEC OPTION function block will contain the following parameter names when viewed using the MMI.

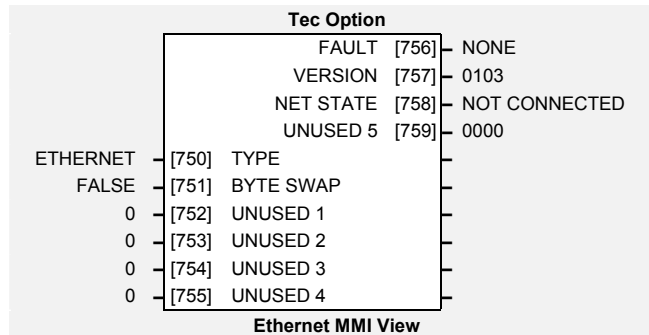
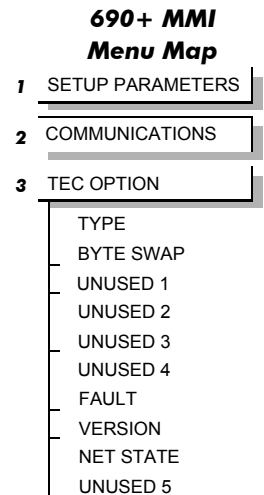

The Non-specific ConfigEd-Lite & MMI View

This is how the TEC OPTION function block looks when viewed using ConfigEd-Lite.

The MMI also displays these non-specific parameter names when the Ethernet option is not yet installed into the drive, or an incorrect TYPE is selected for the fitted Option.

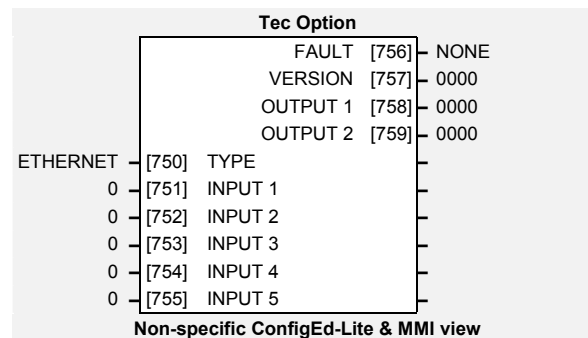
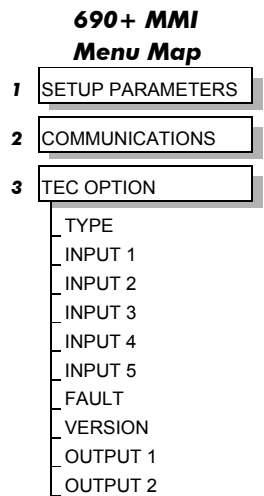

Parameter Descriptions

TYPE

Range: Enumerated - see below

Selects the type of Technology Option. Select ETHERNET for this parameter.

Enumerated Value : Technology Option

- 0 : NONE
- 1 : RS485
- 2 : PROFIBUS DP
- 3 : LINK
- 4 : DEVICENET
- 5 : CANOPEN
- 6 : LONWORKS
- 7 : CONTROLNET
- 8 : MODBUS PLUS
- 9 : ETHERNET

BYTE SWAP

Range: FALSE / TRUE

When this parameter to set TRUE, the byte order is swapped for each 16-bit value being transferred. This typically is required when using the ETHERNET/IP protocol connected to an Allen Bradley PLC.

When using MODBUS TCP/IP protocol, set this parameter to FALSE.

UNUSED 1-4

Reserved for future use.

FAULT

Range: Enumerated - see below

The fault state of the Technology Option.

Enumerated Value : FAULT state

- | | |
|-------------------|------------------------------------|
| 0 : NONE | no faults |
| 1 : PARAMETER | parameter out-of-range |
| 2 : TYPE MISMATCH | TYPE parameter not set to ETHERNET |
| 3 : SELF TEST | hardware fault - internal |
| 4 : HARDWARE | hardware fault - external |
| 5 : MISSING | no option fitted |

VERSION

Range: 0000 to FFFF

The version of the Technology Option card. If no option is fitted then the version is reset to zero. For example, 0103 is version 1.3.

NET STATE

Range: Enumerated - see below

State of the Ethernet network connection.

Enumerated Value : NET STATE

- 0 : CONNECTED
- 1 : NOT CONNECTED
- 2 : DISABLED

UNUSED 5

Reserved for future use.

Note: You can use the functionality of any of the drive's internal Function Blocks with the Technology Option. In some cases, the 590+ drive may require you to use the MiniLINK function block to achieve proper triggering of other function blocks.

IMPORTANT: When using ConfigEd Lite, install the configuration into the drive through the P3 port (RS232 configuration port) using the Command/Install pull-down menu. The configuration is saved directly to the Drive's internal memory. For more details on installing a configuration, refer to the ConfigEd Lite Instruction Manual (RG352747).

Commissioning the Ethernet Technology Option

Configuring the IP address

When the Technology Option is shipped from the factory, all the switches are in the OFF position. The Technology Option will read the switches during initialization. The position of these switches determine how the IP address can be configured.

The IP address can be configured using one of three methods:

1 Configure IP Address using DIL Switches

If the switches are set to a non-zero value the address will come from the DIL switches.

The Subnet mask and Gateway addresses are fixed to the following values:

Subnet mask: 255.255.255.0
Gateway address: 0.0.0.0

The eight position DIL switch represents the binary value of the last byte of the IP address:

Example IP address: 192.168.0.20 where the switches are set to 00010100 (decimal 20)

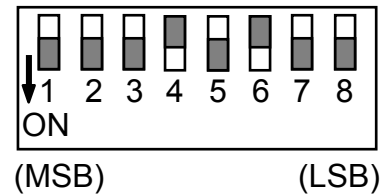

Figure 3. IP Address Selector Switch

2 Configure IP Address using Internet Explorer

Note: The IP address can be configured via the intranet using Internet Explorer™ (version 5.5 or higher). It is possible to use other web browsers, but for our example we will be using Internet Explorer version 6™.

If all switches are in the OFF position (zero value), the IP address will be read from the flash memory that is configured with Internet Explorer™.

1. Set a temporary IP address using the DIL switches. This provides an IP address on the Technology Option. For example, set IP address 192.168.0.20. Refer to Figure 3.
2. Temporarily change the computer's Internet protocol properties to gain access to the intranet that is used with Technology Option. This example will use IP address 192.168.0.1. Refer to Figure 4.

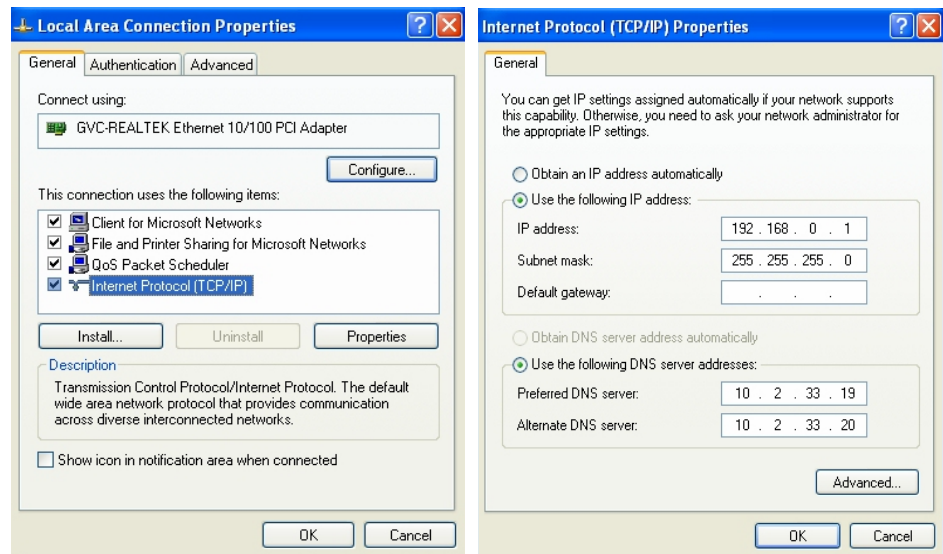

Figure 4. Internet Protocol Properties

3. Launch Internet Explorer™.
4. Go to the intranet address that was set by the DIL switches. The screen shown in Figure 5 will be displayed. Input the desired IP address and Store Configuration.

Note: The Gateway address will need to be set if access from another sub-network is required.

Figure 5. Configuration Web Page

5. Restore all the DIL switches to the OFF position (zero value).

The flash memory in the Technology Box is now programmed. When the Technology Box is initialised on the next power-up cycle, the IP address will come from flash memory, provided that the DIL switches are set to the OFF position (zero value).

3 Using the Address Resolution Protocol (ARP)

The IP address can be changed during runtime using the ARP command from a PC. The new IP address will be stored in the FLASH.

Below is an example on how to change the IP address from a MS DOS™ window:

```
arp -s <IP address> <MAC address>
ping <IP address>
arp -d <IP address>
```

The arp -s command will store the IP and MAC addresses in the PC's ARP table. When the ping command is executed, the PC sends this information to the module using the MAC address. The module detects that it was addressed with the correct MAC address and adopts the IP address sent by the PC. (The arp -d command is optional, but it removes the static route from the PC ARP table).

This method can be used to reconfigure modules that have already been configured, or even to reconfigure modules outside the host's subnet.

The MAC address is printed on a label on the bottom side of the module.

Note: As the Arp command automatically configures the subnet mask to 255.255.255.0, the first three bytes of the IP address must be the same as for the PC executing the command.

Example:

```
PC - 10.10.12.67
Module- 10.10.12.x (Where x is a value between 1 and 254)
```

590 + Point to Point I/O

Point-to-Point I/O connections enable several parameter values to be passed in one transaction. The connections are predefined sets of parameters.

Parker SSD Drives has predefined an assembly object. They are defined on the following pages. These sets are specific to Parker SSD Drives products.

The following table provides a summary of the bytes that are transferred.

| Read/Write | Number of bytes transferred | Drives applicable |
|------------|-----------------------------|-------------------|
| Read | 20 | 590+ |
| Write | 20 | 590+ |

Access: Read from Technology Option

| 590+ | | | | |
|--------|--------------------------------|--------------------------------|---------------------------|--------|
| Bytes | Description | Drive Tag Number | Range | |
| 0, 1 | Sequence Status | 537 | 0000 - FFFF | |
| 2 | Bit-field: | | | |
| | Bit Number: | | | |
| | 0 | User Defined Logic 1 (PNO 112) | Indirect 312 ¹ | Binary |
| | 1 | User Defined Logic 2 (PNO 113) | Indirect 313 ¹ | Binary |
| | 2 | User Defined Logic 3 (PNO 114) | Indirect 314 ¹ | Binary |
| | 3 | User Defined Logic 4 (PNO 115) | Indirect 315 ¹ | Binary |
| | 4 | User Defined Logic 5 (PNO 116) | Indirect 316 ¹ | Binary |
| | 5 | User Defined Logic 6 (PNO 117) | Indirect 317 ¹ | Binary |
| | 6 | User Defined Logic 7 (PNO 118) | Indirect 318 ¹ | Binary |
| 7 | User Defined Logic 8 (PNO 119) | Indirect 319 ¹ | Binary | |
| 3 | Reserved | | | |
| 4, 5 | User Defined Value 1 (PNO 120) | Indirect 320 ¹ | Tag Dependent | |
| 6, 7 | User Defined Value 2 (PNO 121) | Indirect 321 ¹ | Tag Dependent | |
| 8, 9 | User Defined Value 3 (PNO 122) | Indirect 322 ¹ | Tag Dependent | |
| 10, 11 | User Defined Value 4 (PNO 123) | Indirect 323 ¹ | Tag Dependent | |
| 12, 13 | User Defined Value 5 (PNO 124) | Indirect 324 ¹ | Tag Dependent | |
| 14, 15 | User Defined Value 6 (PNO 125) | Indirect 325 ¹ | Tag Dependent | |
| 16, 17 | User Defined Value 7 (PNO 126) | Indirect 326 ¹ | Tag Dependent | |
| 18, 19 | User Defined Value 8 (PNO 127) | Indirect 327 ¹ | Tag Dependent | |

1. Tags 312 to 323 are indirect parameters. Their values are destination tag numbers for Ethernet data. For example, if the value of Tag 320 (PNO 120) is 2, then the value of User Defined Value 1 (bytes 4,5) will be read from Tag 2 (RAMP ACCEL TIME). If some of the User Defined parameters are not required, the corresponding destination tag numbers should be set to 0.
2. Refer to Appendix C for Sequence Status and Remote Sequence details.

Access: Write to Technology Option

| 590+ | | | | |
|--------|---|---|--------------|--------|
| Bytes | Description | Drive Tag Number | Range | |
| 0, 1 | Remote Sequence | 536 ¹ | 0000 to FFFF | |
| 2 | Bit-field: | | | |
| | Bit Number | | | |
| | 0 | User Defined Logic 1 (miniLINK LOGIC 1) | 346 | Binary |
| | 1 | User Defined Logic 2 (miniLINK LOGIC 2) | 347 | Binary |
| | 2 | User Defined Logic 3 (miniLINK LOGIC 3) | 348 | Binary |
| | 3 | User Defined Logic 4 (miniLINK LOGIC 4) | 349 | Binary |
| | 4 | User Defined Logic 5 (miniLINK LOGIC 5) | 350 | Binary |
| | 5 | User Defined Logic 6 (miniLINK LOGIC 6) | 351 | Binary |
| | 6 | User Defined Logic 7 (miniLINK LOGIC 7) | 352 | Binary |
| 7 | User Defined Logic 8 (miniLINK LOGIC 8) | 353 | Binary | |
| 3 | Reserved | | | |
| 4, 5 | User Defined Value 1 (miniLINK VALUE 1) | 339 | ± 100% | |
| 6, 7 | User Defined Value 2 (miniLINK VALUE 2) | 340 | ± 100% | |
| 8, 9 | User Defined Value 3 (miniLINK VALUE 3) | 341 | ± 100% | |
| 10, 11 | User Defined Value 4 (miniLINK VALUE 4) | 342 | ± 100% | |
| 12, 13 | User Defined Value 5 (miniLINK VALUE 5) | 343 | ± 100% | |
| 14, 15 | User Defined Value 6 (miniLINK VALUE 6) | 344 | ± 100% | |
| 16, 17 | User Defined Value 7 (miniLINK VALUE 7) | 345 | ± 100% | |
| 18, 19 | User Defined Value 8 (miniLINK VALUE 8) | 379 | ± 100% | |

1. Tag 536 functions only when REM SEQ ENABLE (Tag 535) is TRUE.
2. Refer to Appendix C for Sequence Status and Remote Sequence details.

690+ Point to Point I/O Connection

Point-to-Point I/O connections enable several parameter values to be passed in one transaction. Lists of parameters to be written to the drive and read from it are predefined.

TechBox parameters are detailed below; the parameters are specific to Parker SSD Drives products. These indicate the drive tag number that is accessed in each case.

The following table provides a summary of the bytes that are transferred.

| Read/Write | Number of bytes transferred | Drives applicable |
|------------|-----------------------------|-------------------|
| Read | 36 | 690+ |
| Write | 36 | 690+ |

Lists of parameters to be written to and from the drive are accessed through Preset Block 5, Preset Block 6, Preset blocks 7, Preset 8, Demux block 1 and Mux block 1. The user is able to link these function blocks to achieve the desired operation. The following tables provide a description of the parameters that are accessed.

Refer to Appendix C for Comms Status and Comms Command details.

Access: Read from TechBox

| 690+ | | | |
|-------|-------------------|------------------|-------------------|
| Bytes | Description | Drive Tag Number | Range |
| 0,1 | Comms Status | 272 | 0000 to FFFF |
| 2,3 | Mux 1 Output | 598 | 0000 to FFFF |
| 4,5 | Preset 7::Input 0 | 543 | -327.68 to 327.67 |
| 6,7 | Preset 7::Input 1 | 544 | -327.68 to 327.67 |
| 8,9 | Preset 7::Input 2 | 545 | -327.68 to 327.67 |
| 10,11 | Preset 7::Input 3 | 546 | -327.68 to 327.67 |
| 12,13 | Preset 7::Input 4 | 547 | -327.68 to 327.67 |
| 14,15 | Preset 7::Input 5 | 548 | -327.68 to 327.67 |
| 16,17 | Preset 7::Input 6 | 549 | -327.68 to 327.67 |
| 18,19 | Preset 7::Input 7 | 550 | -327.68 to 327.67 |
| 20,21 | Preset 5::Input 0 | 521 | -327.68 to 327.67 |
| 22,23 | Preset 5::Input 1 | 522 | -327.68 to 327.67 |
| 24,25 | Preset 5::Input 2 | 523 | -327.68 to 327.67 |
| 26,27 | Preset 5::Input 3 | 524 | -327.68 to 327.67 |
| 28,29 | Preset 5::Input 4 | 525 | -327.68 to 327.67 |
| 30,31 | Preset 5::Input 5 | 526 | -327.68 to 327.67 |
| 32,33 | Preset 5::Input 6 | 527 | -327.68 to 327.67 |
| 34,35 | Preset 5::Input 7 | 528 | -327.68 to 327.67 |

Refer to Appendix C for Comms Status and Comms Command details.

Access: Write to TechBox

| 690+ | | | |
|-------|-------------------|------------------|-------------------|
| Bytes | Description | Drive Tag Number | Range |
| 0,1 | Comms Command | 271 | 0000 to FFFF |
| 2,3 | Demux 1::Input | 599 | 0000 to FFFF |
| 4,5 | Preset 8::Input 0 | 554 | -327.68 to 327.67 |
| 6,7 | Preset 8::Input 1 | 555 | -327.68 to 327.67 |
| 8,9 | Preset 8::Input 2 | 556 | -327.68 to 327.67 |
| 10,11 | Preset 8::Input 3 | 557 | -327.68 to 327.67 |
| 12,13 | Preset 8::Input 4 | 558 | -327.68 to 327.67 |
| 14,15 | Preset 8::Input 5 | 559 | -327.68 to 327.67 |
| 16,17 | Preset 8::Input 6 | 560 | -327.68 to 327.67 |
| 18,19 | Preset 8::Input 7 | 561 | -327.68 to 327.67 |
| 20,21 | Preset 6::Input 0 | 532 | -327.68 to 327.67 |
| 22,23 | Preset 6::Input 1 | 533 | -327.68 to 327.67 |
| 24,25 | Preset 6::Input 2 | 534 | -327.68 to 327.67 |
| 26,27 | Preset 6::Input 3 | 535 | -327.68 to 327.67 |
| 28,29 | Preset 6::Input 4 | 536 | -327.68 to 327.67 |
| 30,31 | Preset 6::Input 5 | 537 | -327.68 to 327.67 |
| 32,33 | Preset 6::Input 6 | 538 | -327.68 to 327.67 |
| 34,35 | Preset 6::Input 7 | 539 | -327.68 to 327.67 |

Refer to Appendix C for Comms Status and Comms Command details.

Network Break Strategy

You can select what the “Write to TechBox” parameters are set to when the network is disconnected.

Set the behaviour using the COMMS TIMEOUT parameter in the COMMS CONTROL Function Block. Also refer to the 690+ Software Product Manual.

| | |
|------------------------|---|
| COMMS TIMEOUT = 0 Secs | When the connection is broken, all parameters being written to the Inverter from the PLC will be set to zero. The Inverter will not Trip. |
| COMMS TIMEOUT > 0 Secs | When the connection is broken, all parameters being written to the Inverter from the PLC will freeze at their last value. After the time specified by the COMMS TIMEOUT parameter has elapsed, the Inverter will Trip (COMMS TIMEOUT Trip). |

Configuring the PLC/SCADA Supervisor

This chapter contains examples for configuring a Modicon and an Allen-Bradley PLC. The Ethernet Technology Box supports the ModBus/TCP protocol and the Ethernet/IP protocol.

Modicon Momentum

3. Start a new program and select the PLC processor and chassis type used in your project. Our example uses an M1 980-20 Momentum PLC. Stay offline until you are ready to download the program.
4. Place an MSTR block in the ladder logic. MSTR blocks move data from the PLC data table to the drive or from the drive to the PLC data table. Two MSTR blocks are necessary for a Read and Write operation.
5. Right click over the MSTR block. This will access the Register Editor. Use the Register Editor to configure the block. The MSTR block has two types of operations: Read or Write. The first register defines the type of operation. In our case address 40100 is used for write command and address 40200 is used for read command. A value of 1 in the data column defines a Write operation. A value of 2 in the data column defines a Read operation.

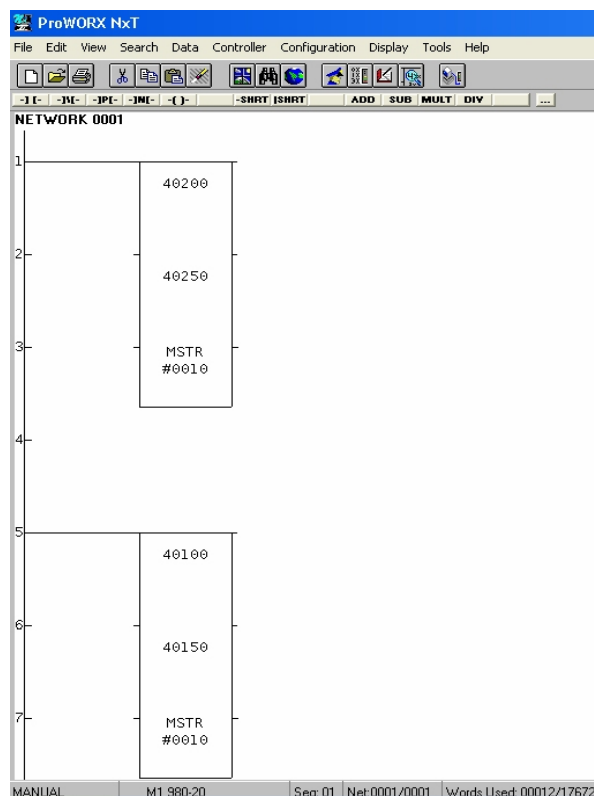

Figure 6. PLC Ladder Logic showing MSTR Blocks

TCP/IP Page 2 of 4

Operation: Read Registers AR:

| Description | Address/Symbol | Data |
|------------------------|----------------|-----------|
| MSTR Operation Code | 40100 | 00002 Dec |
| Error Status | 40101 | 0000 Hex |
| # of Registers | 40102 | 00010 Dec |
| Func Dependent Info | 40103 | 00001 Dec |
| Head # and Map Index | 40104 | 0002 Hex |
| IP Routing Byte 4 | 40105 | 00010 Dec |
| IP Routing Byte 3 | 40106 | 00002 Dec |
| IP Routing Byte 2 | 40107 | 00033 Dec |
| IP Routing Byte 1 | 40108 | 00223 Dec |
| # of Input Regs (FC23) | 40109 | 00000 Dec |
| Server Input Base | 40110 | 00000 Dec |

| Description | Address/Symbol | Data |
|-------------|----------------|----------|
| Source 0001 | 40150 | 0C40 Hex |
| Source 0002 | 40151 | 0005 Hex |
| Source 0003 | 40152 | 0000 Hex |
| Source 0004 | 40153 | 0000 Hex |
| Source 0005 | 40154 | 26FE Hex |

Error:

40102 Prev Next

Close Edit... Doc... Bits... Operation... Radix... Print Help

Figure 7. Read Registers

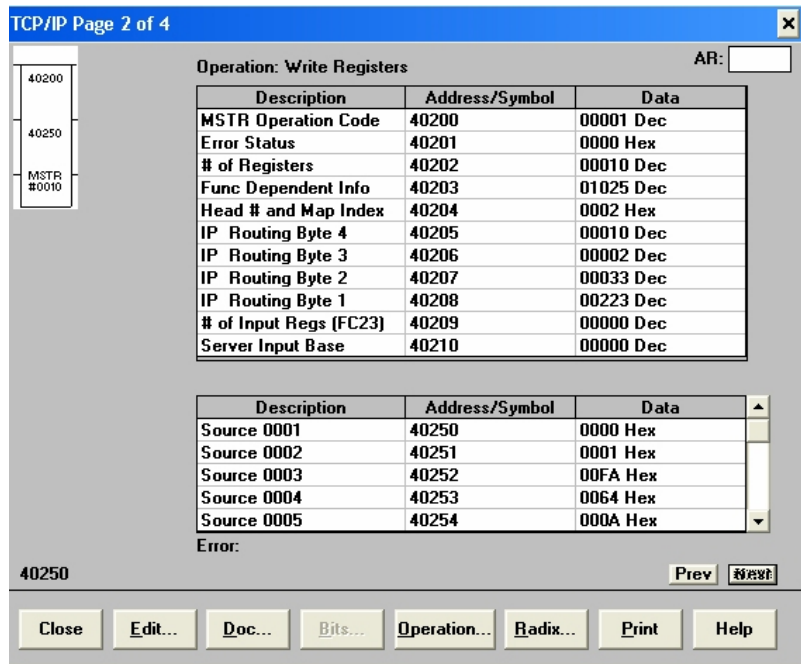

Figure 8 Write Registers

6. The second register contains the error status. Refer to Appendix A for a list of the error codes. The PLC software also has help files that contain a list of error codes.
7. The third register defines the data length (address 40102 or address 40202). The value in the data column depends on which parameter set that has been selected in the drive. The value can be smaller than or equal to the selected parameter set.
8. The fourth register defines the Read and Write locations of the data in the PLC (address 40103 or address 40203). For a Read function, this value is set to 1, and for a Write function this value is set to 1025.
9. Registers 5, 6, 7 and 8 define the IP address on the Ethernet network (address 40104 or address 40204). Our example shows the data registers starting at locations 40150 and 40250.
10. When using the ModBus/TCP protocol the TechBox needs to be programmed with the "BYTE SWAP" FALSE. This applies to Modicon products and other manufactures using the ModBus/TCP protocol.

Allen Bradley ControlLogix

11. Start a new program and select the PLC processor and chassis type that is used in your project. Our example uses a 1756-L55A processor and 1756-A7/B rack. Remain Offline until you are ready to download the program.
12. Using the I/O Configuration insert the Ethernet interface that will be installed. Right click on the I/O Configuration, select New Module. Our example uses 1756-ENBT/A. Input the desired IP address and slot in the PLC. Refer to Figures 9 and 10.

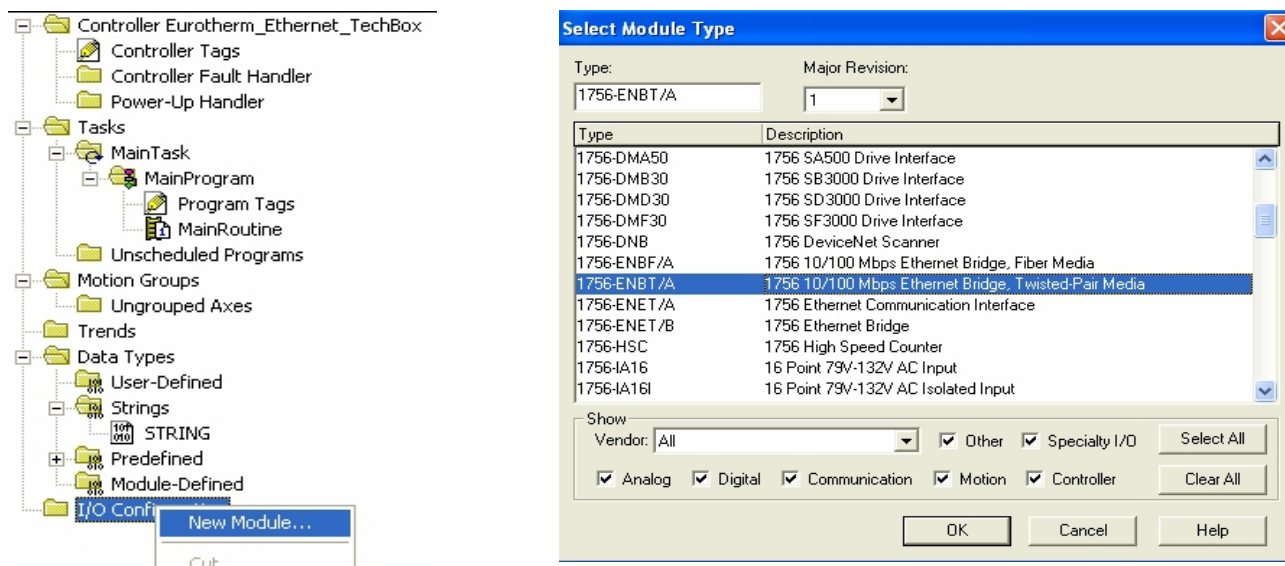

Figure 9. Ethernet Interface Selection

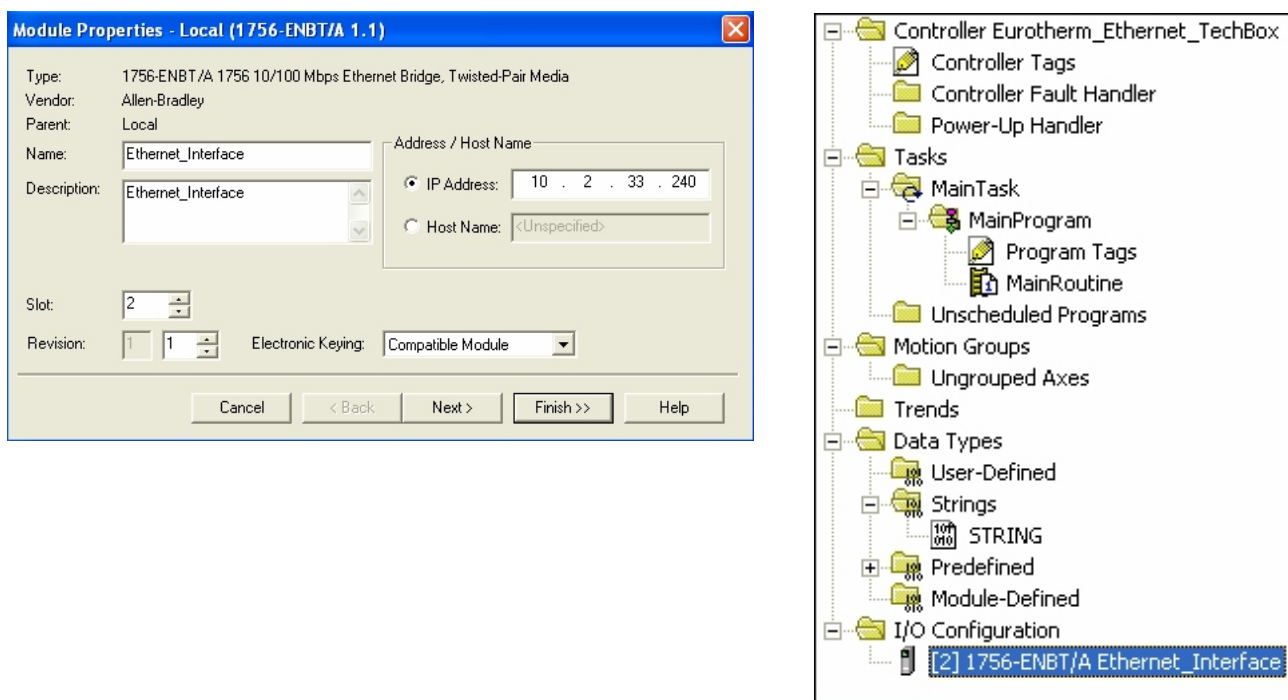

Figure 10. Ethernet Interface Setup

- Right click on the Ethernet Interface Module, select New Module. This screen will allow the selection of the Generic Ethernet Module. Refer to Figure 11.

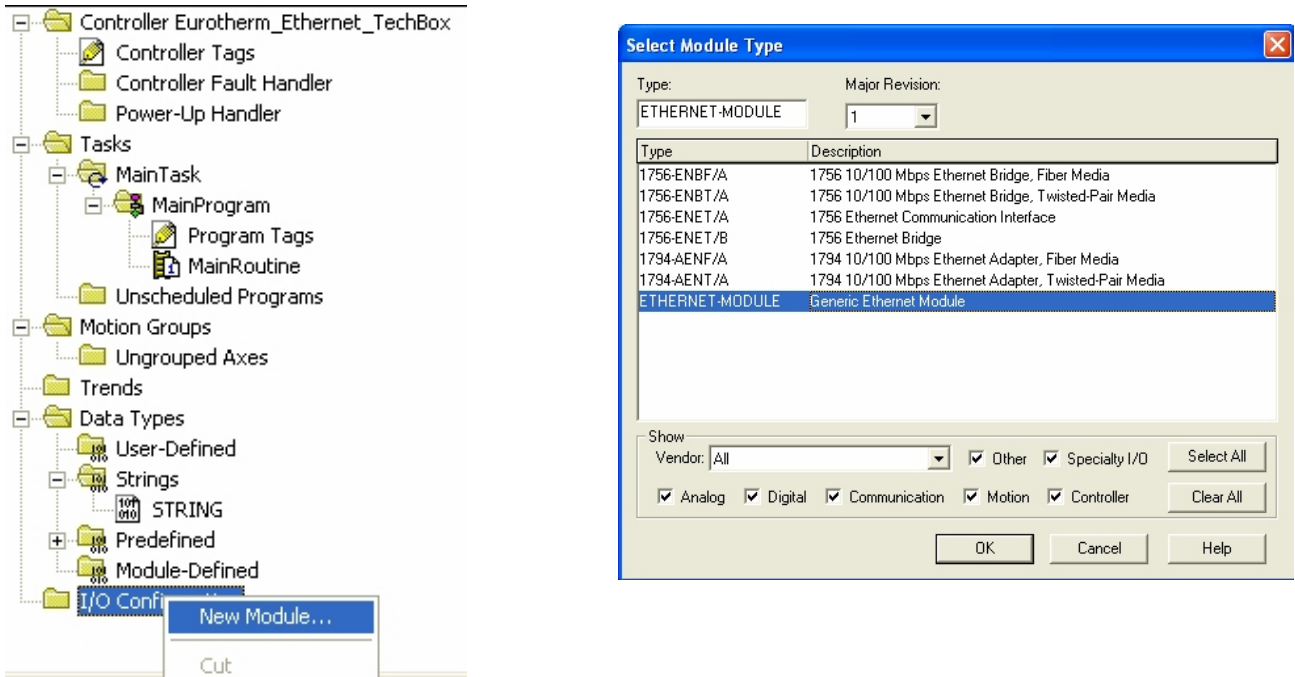

Figure 11. Generic Ethernet Module Select

- Input the desired module name and IP address. The Comms format will be DATA Int. (16 bit). The Input Assembly Instance is 100 and the Output Assembly Instance is 150. The data size for the 590 Plus is 10 words and the data size for the 690 Plus is 18 words. Refer to Figure 12.
- Click on Next to change the Requested Packet Interval (RPI). The default value of 10ms should be sufficient. If The RPI is set below 5ms unreliable communications will be experienced. Refer to Figure 12.

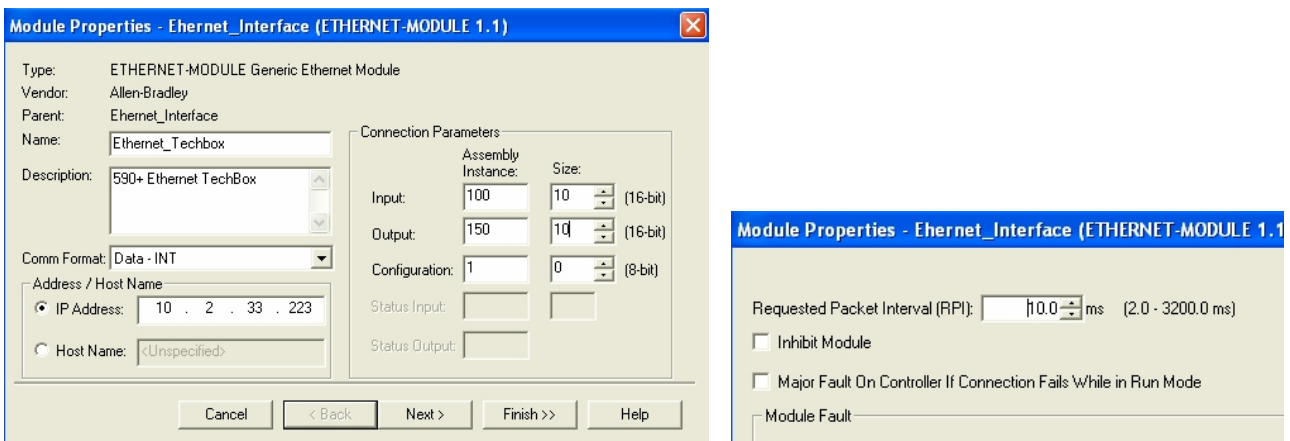

Figure 12. Generic Ethernet Module Setup

16. When completed with the setup of the Generic Ethernet Module it can be downloaded to the PLC. For testing purposes it is not necessary to program Ladder Logic in the PLC. The data can be accessed and monitored via Controller Tags. Refer to Figure 13.

| Tag Name | Value | Force M | Style | Type |
|------------------------------|---------|---------|---------|-----------------------|
| + Ethernet_Techbox:C | {...} | {...} | | AB:ETHERNET_MODULE... |
| - Ethernet_Techbox:I | {...} | {...} | | AB:ETHERNET_MODULE... |
| - Ethernet_Techbox:I.Data | {...} | {...} | Decimal | INT[10] |
| + Ethernet_Techbox:I.Data[0] | 16#0c40 | | Hex | INT |
| + Ethernet_Techbox:I.Data[1] | 0 | | Decimal | INT |
| + Ethernet_Techbox:I.Data[2] | 0 | | Decimal | INT |
| + Ethernet_Techbox:I.Data[3] | 0 | | Decimal | INT |
| + Ethernet_Techbox:I.Data[4] | 0 | | Decimal | INT |
| + Ethernet_Techbox:I.Data[5] | 0 | | Decimal | INT |
| + Ethernet_Techbox:I.Data[6] | 0 | | Decimal | INT |
| + Ethernet_Techbox:I.Data[7] | 0 | | Decimal | INT |
| + Ethernet_Techbox:I.Data[8] | 0 | | Decimal | INT |
| + Ethernet_Techbox:I.Data[9] | 0 | | Decimal | INT |
| - Ethernet_Techbox:O | {...} | {...} | | AB:ETHERNET_MODULE... |
| - Ethernet_Techbox:O.Data | {...} | {...} | Decimal | INT[10] |
| + Ethernet_Techbox:O.Data[0] | 16#0201 | | Hex | INT |
| + Ethernet_Techbox:O.Data[1] | 0 | | Decimal | INT |
| + Ethernet_Techbox:O.Data[2] | 0 | | Decimal | INT |
| + Ethernet_Techbox:O.Data[3] | 0 | | Decimal | INT |
| + Ethernet_Techbox:O.Data[4] | 0 | | Decimal | INT |
| + Ethernet_Techbox:O.Data[5] | 0 | | Decimal | INT |
| + Ethernet_Techbox:O.Data[6] | 0 | | Decimal | INT |

Figure 13. Controller Tags

17. When using the Ethernet/IP protocol the Technology Box needs to be programmed with the “BYTE SWAP” TRUE. This applies to Allen Bradley products and other manufactures using the Ethernet/IP protocol.

Appendix A: Ethernet Error Codes

Error Codes (Modbus Plus & SY/MAX Ethernet)

Error Status Register: 4xxxx + 1 (HEX)

Error Coding: Mmss where M = major code, m = minor code, ss = sub code

- n 16#1001: User initiated abort.
- n 16#20ss: Invalid command errors.
- n 16#30ss: Modbus slave exception response.
- n 16#4001: Inconsistent Modbus slave response.
- n 16#5001: Inconsistent network response.
- n 16#6mss: Routing failure.
- n 16#F001: Selected S985 option is not present.

Invalid Command Errors

Error Status Register: 4xxxx+1 (HEX)

Error Coding: Mmss where M = major code, m = minor code, ss = sub code

- n 2001: Invalid operation type.
- n 2002: User parameter changed.
- n 2003: Invalid length.
- n 2004: Invalid offset.
- n 2005: Invalid length + offset.
- n 2006: Invalid SDDA (Slave Device Data Area).
- n 2007: Invalid SDNA (Slave Device Network Address).
- n 2008: Invalid SDNR (Slave Device Network Routing).
- n 2009: Invalid route (= own address).

- n 200A: Global read request > available.
- n 200B: Peer Cop conflict on write/read global data.
- n 200C: Bad pattern for change address request.
- n 200D: Bad address for change address request.

Ethernet/Modbus Slave Exception Response

Error Status Register: 4xxxx+1 (HEX)

Error Coding: Mmss where M = major code, m = minor code, ss = sub code

- n 3001: Illegal function request (not available in slave).
- n 3002: Illegal data address (not configured in slave).
- n 3003: Illegal data value (Read/Write data not valid).
- n 3004: Not used (unknown error).
- n 3005: Slave accepted long duration program command.
- n 3006: Requested function cannot be performed due to long command in progress.
- n 3007: Slave rejected long program command.

Routing Failures

Error Status Register: 4xxxx + 1 (HEX)

Error Coding: Mmss where M = major code, m = minor code, ss = sub code

Routing failure error code: 6mjj

- n 6m01: No response.
- n 6m02: Program access denied.
- n 6m03: Node is offline and unable to communicate.
- n 6m04: Exception response received.
- n 6m05: Route node data paths busy.
- n 6m06: Slave device down.
- n 6m07: Bad destination address.
- n 6m08: Invalid node type in routing.
- n 6m10: Slave rejected the Modbus command.
- n 6m20: Slave forgot initiated translation.

- n 6m40: Unexpected master output path received.
- n 6m80: Unexpected response received.

Note: m = index to location in the routing information where routing problem was discovered.

0 = local network station

1 = first device in route

2 = second device in route, etc.

Ethernet/Modbus Slave Exception Response

Error Status Register: 4xxxx+1 (HEX)

Error Coding: Mmss where M = major code, m = minor code, ss = sub code

- n 3001: Illegal function request (not available in slave).
- n 3002: Illegal data address (not configured in slave).
- n 3003: Illegal data value (Read/Write data not valid).
- n 3004: Not used (unknown error).
- n 3005: Slave accepted long duration program command.
- n 3006: Requested function cannot be performed due to long command in progress.
- n 3007: Slave rejected long program command.

Error Codes (Allen Bradley Communication Modules)

| Module Faults: 16#0001 - 16#00ff | | |
|---|--|---|
| Code: | String: | Explanation and Possible Causes/Solutions: |
| 16#0004 | Connection Request Error: Bad Segment | The controller is attempting to make a connection to the module and has received an error. |
| 16#0005 | Connection Request Error: Bad Class | The controller is attempting to make a connection to the module and has received an error |
| 16#0008 | Service Request Error: Unsupported Service | The controller is attempting to request a service from the module and has received an error. |
| 16#0009 | Module Configuration Invalid: parameter error. Note: Additional Error Information for this fault will be displayed as a hex code on the Connection Tab. | The configuration for the module is invalid. The module configuration may have been changed in the Tag Monitor or programmatically. Verify that the configuration is valid by using the module configuration software to validate your configuration. |
| 16#000c | Service Request Error: Invalid mode/state for service request | The controller is attempting to request a service from the module and has received an error.Ensure that the module is not faulted. § For a Discrete I/O module, this indicates that the module still has limited communications, but has a Major Fault or is currently being Flash Updated. Refer to the Module Info tab to determine the exact cause. |
| 16#0013 | Module Configuration Invalid: data size too small. | The configuration for the module is invalid – not enough configuration data was sent. |
| 16#0015 | Module Configuration Invalid: data size too large. | The configuration for the module is invalid – too much configuration data was sent. |
| 16#0016 | Service Request Error: Unknown Object | The controller is attempting to request a service from the module and has received an error. |

| Module Faults: 16#0100 - 16#01ff | | |
|---|--|--|
| Code: | String: | Explanation and Possible Causes/Solutions: |
| 16#0100 | Connection Request Error: Module in Use. | The controller is attempting to make a specific connection to a module and the module cannot support more than one of these connections. |
| 16#0103 | Service Request Error: CIP transport class not supported. | The controller is requesting services not supported by the module. |
| 16#0106 | Connection Request Error: Module owned and configured by another controller. | The Connection Request to this module has been rejected due to an Ownership conflict with another Owner (e.g., another Controller). This may occur with modules such as output modules which only allow a single Owner to configure and control its outputs. |
| 16#0108 | Connection Request Error: Connection type not supported. | The controller is requesting a connection type not supported by the module. |

| Module Faults: 16#0100 - 16#01ff | | |
|---|--|---|
| Code: | String: | Explanation and Possible Causes/Solutions: |
| 16#0109 | <p>Connection Request Error: Invalid connection size</p> <p>Note: Additional Error Information for this fault will be displayed as the tag name associated with the connection instance number that has the fault.</p> | <p>The controller is attempting to set up a connection with the module and cannot – the size of the connection is invalid.</p> <p>The controller may be attempting to connect to a tag in a producing controller whose size does not match the tag in this controller.</p> |
| 16#0110 | <p>Connection Request Error: Module not configured</p> | <p>The controller is attempting to set up a Listen Only connection with the module and cannot – the module has not been configured and connected to by an Owner (e.g., another Controller).</p> <p>This controller is not an Owner of this module since it is attempting to establish a Listen-Only connection, which requires no module configuration. It cannot connect until an Owner configures and connects to the module first.</p> |
| 16#0111 | <p>Requested Packet Interval (RPI) out of range.</p> | <p>The Requested Packet Interval (RPI) specified is invalid for this module or for a module in the path to this module.§</p> <p>For Listen-Only connections: the RPI set by the owner of this module is slower than the one requested. Either increase the requested RPI or decrease the RPI the owner controller is using. See the Connection tab for valid RPI values.</p> |
| 16#0113 | <p>Connection Request Error: Module connection limit exceeded.</p> | <p>This module (or a module in the path to this module) has exceeded its connection capacity. Reduce the total number of connections used by this module.</p> |
| 16#0114 | <p>Electronic Keying Mismatch: Electronic Keying product code mismatch.</p> | <p>The Product Code of the actual module hardware does not match the Product Code of the module created in the software.</p> <p>Electronic Keying failed for this module. You may have a mismatch between the module created in the software and the actual module hardware.</p> |
| 16#0115 | <p>Electronic Keying Mismatch: Electronic Keying product type mismatch.</p> | <p>The Product Type of the actual module hardware does not match the Product Type of the module created in the software.</p> <p>Electronic Keying failed for this module. You may have a mismatch between the module created in the software and the actual module hardware.</p> |
| 16#0116 | <p>Electronic Keying Mismatch: Major and/or Minor revision invalid or incorrect</p> | <p>The Major and/or Minor revisions of the module do not match the Major and/or Minor revisions of the module created in the software.</p> <p>Ensure that you have specified the correct Major and Minor Revision if you have chosen Compatible Module or Exact Match keying.</p> <p>Electronic Keying failed for this module. You may have a mismatch between the module created in the software and the actual module hardware.</p> |

| Module Faults: 16#0100 - 16#01ff | | |
|---|--|--|
| Code: | String: | Explanation and Possible Causes/Solutions: |
| 16#0117 | <p>Connection Request Error: Invalid Connection Point.</p> <p>Note: Additional Error Information for this fault appears as the tag name associated with the controller to controller (C2C) that has the fault.</p> | <p>The controller is attempting to make a connection to the module and has received an error.</p> <p>Another controller owns this module and has connected with a Communications Format different than the one chosen by this controller.</p> <p>Ensure that the Communications Format chosen is identical to that chosen by the first owner controller of the module.</p> <p>The controller may be attempting to connect to a non-existent tag in a producing controller.</p> |
| 16#0118 | Module Configuration Invalid: format error | The configuration for the module is invalid. |
| 16#0119 | Connection Request Error: Module does not have an owner | <p>The controller is attempting to set up a listen-only connection with the module and cannot – the module does not have an owner.</p> <p>This fault may temporarily occur when the system is powered up and will be cleared when an owner controller connects to and configures the module.</p> |
| 16#011a | Connection Request Error: Out of Connection Resources | The controller is attempting to set up a connection with the module and cannot – resources required are unavailable. |



















| Module Faults: 16#0200 - 16#02ff | | |
|---|---|--|
| Code: | String: | Explanation and Possible Causes/Solutions: |
| 16#0203 | Connection timed out. | <p>The connection to this module has been interrupted causing a loss of communication.</p> <p>Ensure that the module has not been removed and is still functioning and is receiving power.</p> <p>Ensure that the network connection to this module has not been interrupted.</p> <p>Note: If a connection to an output module times out and the output module supports Fault Mode and the output module is still functioning, its outputs will transition to the configured Fault Mode.</p> |
| 16#0204 | Connection Request Error: Connection request timed out. | <p>The controller is attempting to make a connection to the module and the module is not responding.</p> <p>The controller is not able to communicate with the module. Ensure that the module has not been removed and is still functioning and is receiving power.</p> <p>Ensure you have entered the correct slot number. Ensure that the network connection to the module has not been interrupted.</p> |
| 16#0205 | Connection Request Error: Invalid parameter. | The controller is attempting to set up a connection with the module and has received an error – a parameter is in error. |
| 16#0206 | Connection Request Error: request size too large. | <p>The controller is attempting to set up a connection with the module and has received an error – the request size is too large.</p> <p>Ensure that the path to this module is sufficiently close to the controller.</p> |

| Module Faults: 16#0300 - 16#03ff | | |
|---|--|--|
| Code: | String: | Explanation and Possible Causes/Solutions: |
| 16#0301 | Connection Request Error: Out of buffer memory. | <p>The controller is attempting to set up a connection with the module and has received an error – a module in the path is out of memory.</p> <p>The controller may be attempting to connect to a tag in a producing controller that is not marked as being produced.</p> <p>The controller may be attempting to connect to a tag in a producing controller. That tag may not be configured to allow enough consumers. § Reduce the size or number of connections through this module.</p> <p>One of the network modules between the module and the controller may be out of memory. Check network configuration of the system.</p> <p>The module may be out of memory. Check system configuration and capabilities of module.</p> |
| 16#0302 | Connection Request Error: Out of communication bandwidth. | <p>The controller is attempting to set up a connection with the module and has received an error – a module in the path has exceeded its communication bandwidth capacity. Increase the Requested Packet Interval (RPI).</p> <p>Distribute the load on another bridge module.</p> |
| 16#0303 | Connection Request Error: No bridge available. | <p>The controller is attempting to set up a connection with the module and has received an error – a module in the path has exceeded its communication bandwidth capacity. Distribute the load on another bridge module.</p> |
| 16#0311 | Connection Request Error: Invalid port. | <p>The controller is attempting to set up a connection with the module and has received an error.</p> |
| 16#0312 | Connection Request Error: Invalid link address. | <p>The controller is attempting to set up a connection with the module and has received an error – an invalid link address has been specified. A link address can be a slot number, a network address, or the Remote I/O Rack number and starting group.</p> <p>Ensure that the chosen slot number for this module is not greater than the size of the rack.</p> |
| 16#0315 | Connection Request Error: Invalid segment type. | <p>The controller is attempting to set up a connection with the module and has received an error – the connection request is invalid.</p> |
| 16#0317 | Connection Request Error: Connection not scheduled. | <p>The controller is attempting to set up a connection with the module and has received an error.</p> |
| 16#0319 | Connection Request Error: No secondary resources available in redundant chassis. | <p>The controller is attempting to set up a connection with the module and has received an error – the redundant module does not have the necessary resources to support the connection.</p> <p>Reduce the size or number of connections through this module or add another Controller.</p> |
| 16#031d | Connection Request Error: Tag not published. | <p>The controller is attempting to connect to a tag in a producing controller and has received an error.</p> <p>The controller may be attempting to connect to a tag in a producing controller and that tag is not marked as 'published'.</p> |

| Module Faults: 16#0300 - 16#03ff | | |
|---|---|---|
| Code: | String: | Explanation and Possible Causes/Solutions: |
| 16#031e | Connection Request Error: Cannot consume tag. | <p>The controller is attempting to connect to a tag in a producing controller and has received an error.</p> <p>The controller is attempting to connect to a tag in a producing controller and that tag has already been used by too many consumers. Increase the maximum number of consumers on the tag.</p> |

Appendix B: Troubleshooting

6053/6055 Ethernet Technology Option Status LED

| LED Indications | | Cause/Symptom | Remedy |
|--|---|--|---|
| NETWORK | MODULE | | |
|  (OFF) |  | No power at the drive. | Check and apply power to the drive. |
|  |  | Technology Option not installed correctly. | Check connections between Technology Option and drive. On 690B, check the ribbon cable. |
|  |  | Hardware fault. 690B WARNING: Remove the terminal cover and the Technology Option whilst connected to see the drive's HEALTH and RUN LEDs. BEWARE OF ELECTRIC SHOCK. | If HEALTH and RUN LEDs are OFF, replace the drive, or replace the Technology Option. |
|  |  | Self test failed | Commission the Technology Option correctly Hardware fault |
|  |  | Incorrect Technology Option fitted or selected | Select the matching value for the TYPE parameter in the TEC OPTION function block. (TYPE = ETHERNET). |
|  |  | No network connection. Disabled or initialising. | Valid set-up, ready for external communications |
|  |  | No network connection | Connection refused - scanner problems |
|  |  | Foced listen mode Checking for moderator Duplicate Node ID | |
|  |  | Network Connection; no faults | Normal operating state. |

Returning the Unit to Parker SSD Drives

Please have the following information available:

- The model and serial number - see the unit's rating label
- Details of the fault

Contact your nearest Parker SSD Drives Service Centre to arrange return of the item.

You will be given a *Returned Material Authorisation*. Use this as a reference on all paperwork you return with the faulty item. Pack and despatch the item in the original packing materials; or at least an anti-static enclosure. Do not allow packaging chips to enter the unit.

Disposal

This product contains materials which are consignable waste under the Special Waste Regulations 1996 which complies with the EC Hazardous Waste Directive - Directive 91/689/EEC.

We recommend you dispose of the appropriate materials in accordance with the valid environmental control laws. The following table shows which materials can be recycled and which have to be disposed of in a special way.

| Material | Recycle | Disposal |
|-----------------------|---------|----------|
| metal | yes | no |
| plastics material | yes | no |
| printed circuit board | no | yes |

The printed circuit board should be disposed of in one of two ways:

1. High temperature incineration (minimum temperature 1200°C) by an incinerator authorised under parts A or B of the Environmental Protection Act
2. Disposal in an engineered land fill site that is licensed to take aluminium electrolytic capacitors. Do not dispose of in a land fill site set aside for domestic waste.

Packaging

During transport our products are protected by suitable packaging. This is entirely environmentally compatible and should be taken for central disposal as secondary raw material.

Appendix C: External Control of the Drive

590+

REM. SEQUENCE

Tag 536, Mnemonic "ow" EI ASCII, Default = 0x0000

Reserved bits are undefined when read and should be set Zero when written.

| Bit Number | Mask | Name | Comment |
|------------|--------|--------------------|---------------------------|
| 0 (lsb) | 0x0001 | Remote Enable | |
| 1 | 0x0002 | Remote Start | |
| 2 | 0x0004 | Remote Jog | |
| 3 | 0x0008 | Remote Jog Mode | Selects Jog Speed |
| 4 | 0x0010 | Reserved | |
| 5 | 0x0020 | Reserved | |
| 6 | 0x0040 | Reserved | |
| 7 | 0x0080 | Reserved | |
| 8 | 0x0100 | Remote Alarm Ack | Alarm Acknowledge |
| 9 | 0x0200 | Remote/Remote Trip | Remote Trip (High for OK) |
| 10 | 0x0400 | Reserved | |
| 11 | 0x0800 | Reserved | |
| 12 | 0x1000 | Reserved | |
| 13 | 0x2000 | Reserved | |
| 14 | 0x4000 | Reserved | |
| 15 | 0x8000 | Reserved | |

Useful commands using EI-ASCII - REM. SEQUENCE

Tag 536, Mnemonic "ow", Default = 0x0C07

| | /Remote Trip | Alarm Ack | Jog Mode | Jog | Start | Enable | Command |
|----------------|--------------|-----------|----------|-----|-------|--------|-----------------------|
| Start Drive | 1 | 0 | X | 0 | 1 | 1 | 0x0203 |
| Stop Drive | 1 | 0 | X | 0 | 0 | 1 | 0x0201 |
| Disable Drive | 1 | 0 | X | X | X | 0 | 0x0200 |
| Jog Setpoint 1 | 1 | 0 | 0 | 1 | 0 | 1 | 0x0205 |
| Jog Setpoint 2 | 1 | 0 | 1 | 1 | 0 | 1 | 0x020C |
| Remote Trip | 0 | 0 | X | X | X | X | 0x0000 |
| Reset Alarm a) | 1 | 1 | 0 | 0 | 0 | 0 | 0x0300 |
| Reset Alarm b) | | | | | | | Healthy Output Bit 11 |
| Reset Alarm c) | 1 | 0 | 50 | 0 | 0 | 0 | 0x0200 |

Drive Enable

To enable the drive in remote mode the following parameters must be TRUE:
REM.SEQ.ENABLE [535] and REM SEQUENCE [536] BIT 1.

Drive Start

To start the drive in remote mode the following parameters must be TRUE:
REM.SEQ.ENABLE [535] and REM SEQUENCE [536] BIT 0.

Drive Jog

To jog the drive in remote mode the following parameters must be TRUE:
REM.SEQ.ENABLE [535] and REM SEQUENCE [536] BIT 3.

Jog Mode

To select the jog setpoint in remote mode the following parameters must be TRUE:
REM.SEQ.ENABLE [535] and REM SEQUENCE [536] BIT 4.

ACK Alarm

To acknowledge an alarm the following parameter must be TRUE:
REM SEQUENCE [536] BIT 8.

NOTE: if remote sequencing is not enabled then REM SEQUENCE [536] BIT 8 is forced TRUE.

SEQ STATUS

Tag 537, Mnemonic "ox" – EI ASCII (Read Only) , Default = 0x0000

Reserved bits are undefined when read.

| Bit Number | Mask | Name | Comment |
|------------|--------|----------------|---|
| 0 (lsb) | 0x0001 | Coast Stop | Coast Stop demanded |
| 1 | 0x0002 | Program Stop | Program (Fast) Stop demanded |
| 2 | 0x0004 | Disable | /Enable demanded |
| 3 | 0x0008 | Run | Drive Start demanded |
| 4 | 0x0010 | Jog | Drive Jog demanded |
| 5 | 0x0020 | Reserved | Undefined |
| 6 | 0x0040 | Alarm | Unacknowledged alarm (Health Store! = 0) |
| 7 | 0x0080 | Reserved | Undefined |
| 8 | 0x0100 | Running | Contactora in and drive ready to be enabled |
| 9 | 0x0200 | Enabled | Drive is enabled. |
| 10 | 0x0400 | Zero Speed | Zero speed Output TAG 17 |
| 11 | 0x0800 | Healthy Output | Healthy Output TAG 12 |
| 12 | 0x1000 | Ready | Ready Output TAG 559 |
| 13 | 0x2000 | Reserved | Undefined |
| 14 | 0x4000 | Reserved | Undefined |
| 15 | 0x8000 | Reserved | Undefined |

Useful Bit Patterns and Status Words

| Sequence Status | Status Words | | Comment |
|---------------------|--------------|-------------|--|
| Binary | Decimal | Hexadecimal | |
| 0001 1011 0000 1011 | 6923 | 0x1B0B | Running |
| 0000 0100 0100 1011 | 1099 | 0x044B | Tripped, Run High |
| 0000 0100 0100 0111 | 1095 | 0x0447 | Tripped, Run Low, Enable Low |
| 0000 1100 0100 0111 | 3143 | 0x0C47 | Trip Acknowledged, Healthy o/p TRUE Alarm stays high until drive is restarted. |

Remote Trip Alarm

The Remote trip alarm is designed to signal a network fault to the drive. When using the Ethernet interface, all outputs are set to zero on link fail. If one of the outputs is REM SEQUENCE [536] the drive will trip after a delay specified by REM TRIP DELAY (541). The Drive will then need a low -> high transition on ACK Alarm and Start before the drive may run again.

| REM TRIP INHIBIT [540] | REM TRIP DELAY [541] | REMOTE TRIP [542] |
|------------------------|---|--|
| Disable remote trip. | Delay before trip becomes active after bit being cleared. | Status of the Remote trip alarm, OK, Warning (Remote Seq Bit 9 FALSE and delay not expired), Active (Trip active, timer expired and remote not inhibited). |

690+**Communications Command**

When sequencing is in the Remote Comms mode, the sequencing of the Inverter is controlled by writing to the hidden parameter COMMS COMMAND (Tag 271). This parameter can only be written to using a communications interface. The output parameter (Tag 273) COMMS COMMAND of the COMMS CONTROL function block is provided as a diagnostic.

The COMMS COMMAND parameter is a 16-bit word based on standard fieldbus drive profiles. Some bits are not implemented in this release (see “Supported” column of the table below).

| Bit | Name | Description | Supported | Required Value |
|-----|-----------------------|-------------------------------|-----------|----------------|
| 0 | Switch On | OFF1 Operational | √ | |
| 1 | (Not) Disable Voltage | OFF2 Coast Stop | √ | |
| 2 | (Not) Quick Stop | OFF3 Fast Stop | √ | |
| 3 | Enable Operation | | √ | |
| 4 | Enable Ramp Output | =0 to set ramp output to zero | | 1 |
| 5 | Enable Ramp | =0 to hold ramp | | 1 |
| 6 | Enable Ramp Input | =0 to set ramp input to zero | | 1 |
| 7 | Reset Fault | Reset on 0 to 1 transition | √ | |
| 8 | | | | 0 |
| 9 | | | | 0 |
| 10 | Remote | =1 to control remotely | | 1 |
| 11 | | | | 0 |
| 12 | | | | 0 |
| 13 | | | | 0 |
| 14 | | | | 0 |
| 15 | | | | 0 |

Switch On

Replaces the RUN FWD, RUN REV and NOT STOP parameters of the SEQUENCING LOGIC function block. When Set (=1) is the same as:

RUN FWD = TRUE
 RUN REV = FALSE
 NOT STOP = FALSE

When Cleared (= 0) is the same as :

RUN FWD = FALSE
 RUN REV = FALSE
 NOT STOP = FALSE

(Not) Disable Voltage

ANDed with the NOT COAST STOP parameter of the SEQUENCING LOGIC function block. When both are Set (=1) is the same as:

= TRUE

When either or both Cleared (= 0) is the same as:

NOT COAST STOP = FALSE

(Not) Quick Stop

ANDed with the NOT FAST STOP parameter on the SEQUENCING LOGIC function block. When both are Set (=1) is the same as:

NOT FAST STOP = TRUE

When either or both Cleared (= 0) is the same as:

NOT FAST STOP = FALSE

Enable Operation

ANDed with the DRIVE ENABLE parameter on the SEQUENCING LOGIC function block. When both are Set (=1) is the same as:

DRIVE ENABLE = TRUE

When either or both Cleared (= 0) is the same as:

DRIVE ENABLE = FALSE

Enable Ramp Output, Enable Ramp, Enable Ramp Input

Not implemented. The state of these bits must be set (=1) to allow this feature to be added in the future.

Reset Fault

Replaces the REM TRIP RESET parameter on the SEQUENCING LOGIC function block. When Set (=1) is the same as:

REM TRIP RESET = TRUE

When Cleared (= 0) is the same as:

REM TRIP RESET = FALSE

Remote

Not implemented. It is intended to allow the PLC to toggle between local and remote. The state of this must be set (=1) to allow this feature to be added in the future.

| Example Commands |
|------------------|
| RUN 0x047F |
| STOP 0x047E |

Communications Status

The COMMS STATUS parameter (Tag 272) in the COMMS CONTROL function block monitors the sequencing of the Inverter. It is a 16-bit word based on standard fieldbus drive profiles. Some bits are not implemented in the initial release and are set to 0 (see “Supported” column of the table below).

| Bit | Name | Description | Supported |
|-----|------------------------|---|------------------|
| 0 | Ready To Switch On | | √ |
| 1 | Switched On | Ready for operation (refer control bit 0) | √ |
| 2 | Operation Enabled | (refer control bit 3) | √ |
| 3 | Fault | Tripped | √ |
| 4 | (Not) Voltage Disabled | OFF 2 Command pending | √ |
| 5 | (Not) Quick Stop | OFF 3 Command pending | √ |
| 6 | Switch On Disable | Switch On Inhibited | √ |
| 7 | Warning | | |
| 8 | SP / PV in Range | | |
| 9 | Remote | = 1 if Drive will accept Command Word | √ |
| 10 | Target Reached | = 1 if at Setpoint | √ (v5.6 onwards) |
| 11 | Internal Limit Active | = 1 if current or torque limiting | √ (v5.6 onwards) |
| 12 | | | |
| 13 | | | |
| 14 | | | |
| 15 | | | |

Ready To Switch On

Same as the SWITCH ON ENABLE output parameter of the SEQUENCING LOGIC function block.

Switched On

Same as the SWITCHED ON output parameter of the SEQUENCING LOGIC function block.

Operation Enabled

Same as the RUNNING output parameter of the SEQUENCING LOGIC function block.

Fault

Same as the TRIPPED output parameter of the SEQUENCING LOGIC function block.

(Not) Voltage Disabled

If in Remote Comms mode, this is the same as Bit 1 of the COMMS COMMAND parameter. Otherwise it is the same as the NOT COAST STOP input parameter of the SEQUENCING LOGIC function block.

(Not) Quick Stop

If in Remote Comms mode, this is the same as Bit 2 of the COMMS COMMAND parameter. Otherwise it is the same as the NOT FAST STOP input parameter of the SEQUENCING LOGIC function block.

Switch On Disable

Set (=1) only when in START DISABLED state; refer to the product software manual Section 4 Sequencing Logic States.

Remote

This bit is set (= 1) if the Inverter is in Remote mode AND the parameter REMOTE COMMS SEL of the COMMS CONTROL function block is Set (= 1).

Target Reached

This bit is set (= 1) if the Inverter is at Speed Setpoint. It is also set when the Inverter is in the Stopped state.

Internal limit Active

This bit is set (= 1) if the Inverter is in current or torque limit.

Appendix D Sample Configurations

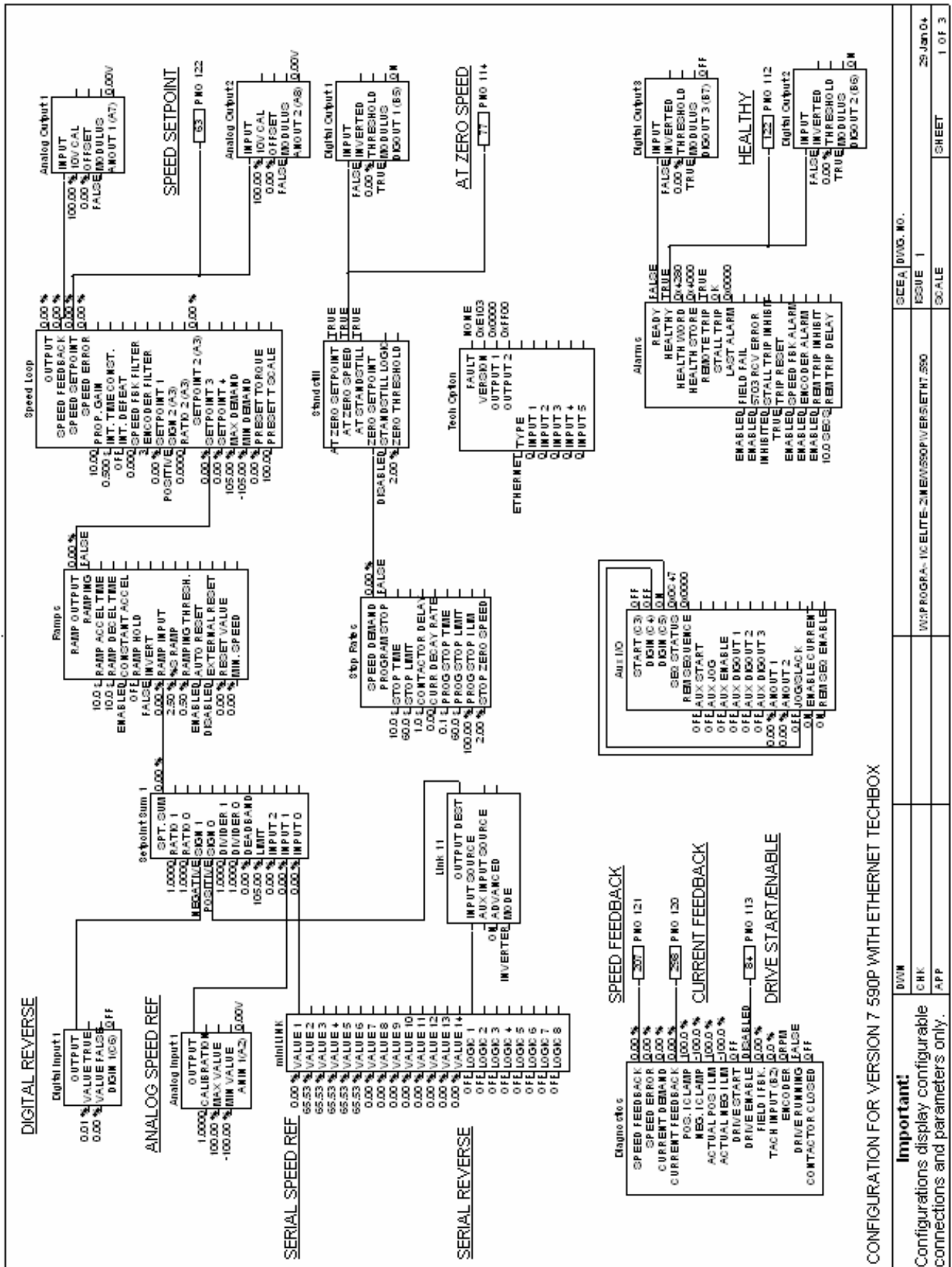

CONFIGURATION FOR VERSION 7 590P WITH ETHERNET TECHBOX

Important!

Configurations display configurable connections and parameters only.

| | | | |
|-------|-----------|-------|---------|
| SCALE | 0.00000 | SCALE | 0.00000 |
| ISSUE | 1 | SCALE | 0.00000 |
| DATE | 29 Jan 04 | SHEET | 1 OF 3 |

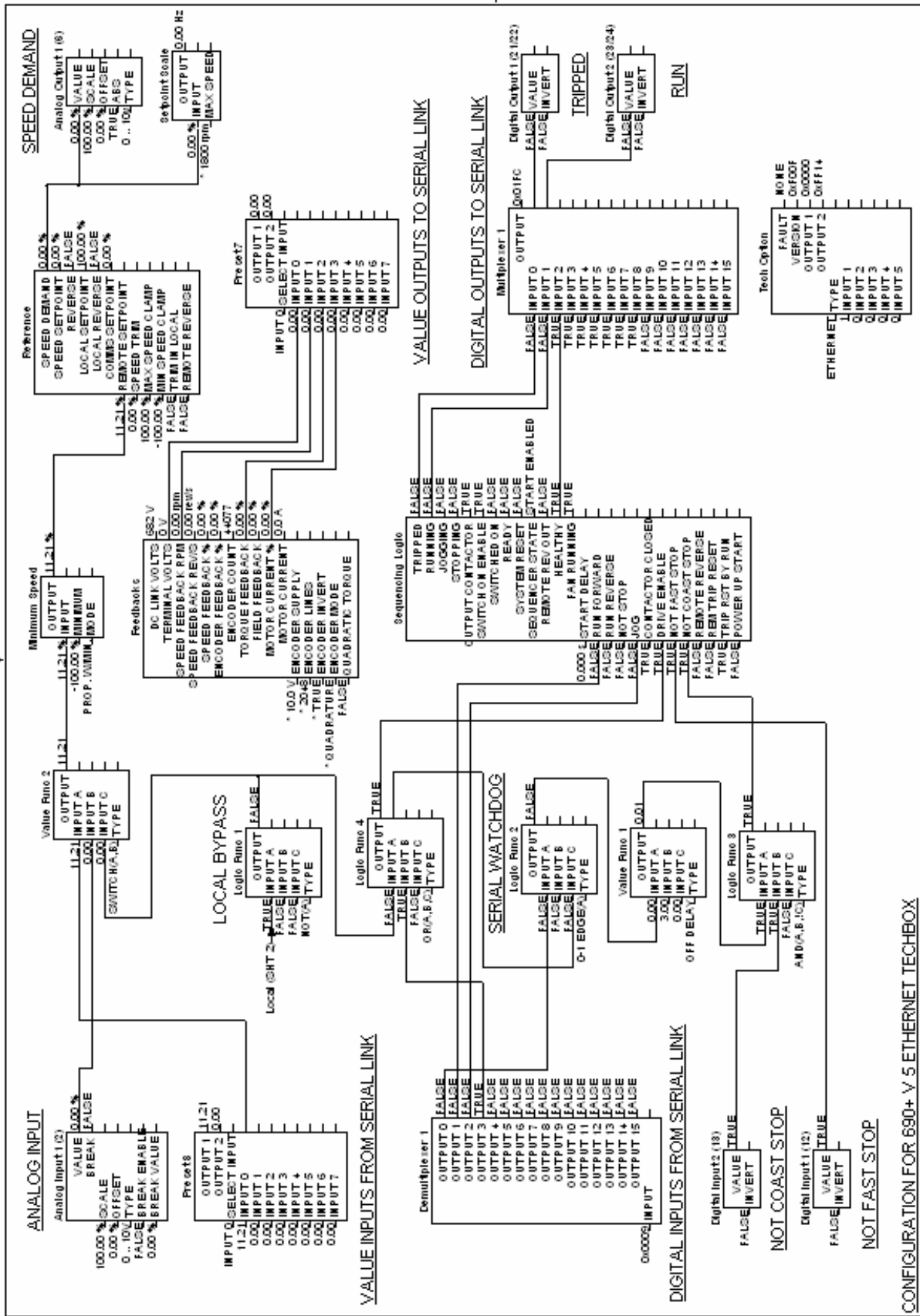

CONFIGURATION FOR 690+ V.5 ETHERNET TECHBOX

| | | | | | |
|---|-----------------------------|---|----------------|---------------|------------------|
| <p>Important: Configurations display configurable connections and parameters only.</p> | <p>D/VM CHK APP</p> | <p>C:\PROGRAMS\10.ELITE-11K\EM550V5V4\ETHNT85.650</p> | <p>SCALE 1</p> | <p>SHEET</p> | <p>05 Feb 03</p> |
| <p>ISSUE 1</p> | | <p>SCALE</p> | | <p>1 OF 8</p> | |
| <p>DC/DC CONV. NO.</p> | | <p>SCALE</p> | | <p>SHEET</p> | |

| ISS. | MODIFICATION | ECN No. | DATE | DRAWN | CHK'D |
|---|-------------------------------|---|----------|-------|--------------------|
| 1 | Initial issue of HA468030U001 | 16551 | 27/02/04 | CM | TL |
| 2 | Company name change | 18354 | 09/12/05 | CM | TL |
| 3 | Company name change | 19591 | 06/08/07 | CM | TL |
| FIRST USED ON | | MODIFICATION RECORD 6053/6055 Ethernet Communications Interface | | | |
|  | | DRAWING NUMBER ZZ468030C001 | | | SHT. 1 OF 1 |