



650 AC Drive

Frames 1, 2, 3

Software Product Manual

HA467872U001 Issue 5

Compatible with Version 4.8 (onwards) Software

© Copyright 2005 SSD Drives Limited (formerly Eurotherm Drives Limited)

All rights strictly reserved. No part of this document may be stored in a retrieval system, or transmitted in any form or by any means to persons not employed by an SSD Drives company without written permission from SSD Drives Ltd.

Although every effort has been taken to ensure the accuracy of this document it may be necessary, without notice, to make amendments or correct omissions. SSD Drives cannot accept responsibility for damage, injury, or expenses resulting therefrom.

WARRANTY

SSD Drives warrants the goods against defects in design, materials and workmanship for the period of 12 months from the date of delivery on the terms detailed in SSD Drives Standard Conditions of Sale IA058393C.

SSD Drives reserves the right to change the content and product specification without notice.

Safety Information



Requirements

IMPORTANT: Please read this information BEFORE installing the equipment.

Intended Users

This manual is to be made available to all persons who are required to install, configure or service equipment described herein, or any other associated operation.

The information given is intended to highlight safety issues, and to enable the user to obtain maximum benefit from the equipment.

Complete the following table for future reference detailing how the unit is to be installed and used.

INSTALLATION DETAILS	
Serial Number <i>(see product label)</i>	
Where installed <i>(for your own information)</i>	
Unit used as a: <i>(refer to Certification for the drive)</i>	<input type="checkbox"/> Component <input type="checkbox"/> Relevant Apparatus
Unit fitted:	<input type="checkbox"/> Wall-mounted <input type="checkbox"/> Enclosure

Application Area

The equipment described is intended for industrial motor speed control utilising AC induction or AC synchronous machines.

Personnel

Installation, operation and maintenance of the equipment should be carried out by qualified personnel. A qualified person is someone who is technically competent and familiar with all safety information and established safety practices; with the installation process, operation and maintenance of this equipment; and with all the hazards involved.

Safety Information



Hazards

WARNING!

This equipment can endanger life through rotating machinery and high voltages. Failure to observe the following will constitute an ELECTRICAL SHOCK HAZARD. This is a product of the restricted sales distribution class according to IEC 61800-3. In a domestic environment this product may cause radio interference in which case the user may be required to take adequate measures. This product is designated as "professional equipment" as defined in EN61000-3-2. Permission of the supply authority shall be obtained before connection to the low voltage supply.

- The equipment must be **permanently earthed** due to the high earth leakage current.
- The drive motor must be connected to an appropriate safety earth.
- The equipment contains high value capacitors which take time to discharge after removal of the mains supply.
- Before working on the equipment, ensure isolation of the mains supply from terminals L1, L2 and L3. Wait for at least 3 minutes for the dc link terminals (DC+ and DC-) to discharge to safe voltage levels (<50V). Measure the DC+ and DC- terminal voltage with a meter to confirm that the voltage is less than 50V.
- Never perform high voltage resistance checks on the wiring without first disconnecting the drive from the circuit being tested.
- When replacing a drive in an application and before returning to use, it is essential that all user defined parameters for the product's operation are correctly installed.
- This equipment contains electrostatic discharge (ESD) sensitive parts. Observe static control precautions when handling, installing and servicing this product.

IMPORTANT: Metal parts may reach a temperature of 90 degrees centigrade in operation.

Application Risk

The specifications, processes and circuitry described herein are for guidance only and may need to be adapted to the user's specific application.

SSD Drives does not guarantee the suitability of the equipment described in this Manual for individual applications.

Risk Assessment

Under fault conditions, power loss or other operating conditions not intended, the equipment may not operate as specified. In particular:

- The motor speed may not be controlled
- The direction of rotation of the motor may not be controlled
- The motor may be energised

Guards

The user must provide guarding and /or additional safety systems to prevent risk of injury and electric shock.

Protective Insulation

- All control and signal terminals are SELV, i.e. protected by double insulation. Ensure all wiring is rated for the highest system voltage.

Note: *Thermal sensors contained within the motor must be double insulated.*

- All exposed metalwork in the drive is protected by basic insulation and bonding to a safety earth.

RCDs

These are not recommended for use with this product but, where their use is mandatory, only Type B RCDs should be used.

Contents

Chapter 1 PROGRAMMING YOUR APPLICATION

Modifying a Block Diagram Over Comms	1-1
• Execution Rules	1-1
• Saving Your Modifications	1-1
Function Block Descriptions	1-2
Understanding the Function Block Description	1-2
Function Blocks by Category	1-3
Function Blocks in Alphabetical Order	1-4
• ANALOG INPUT	1-4
• ANALOG OUTPUT	1-6
• APP CONFIG	1-7
• AUTO RESTART	1-8
• COMMS CONTROL	1-9
• COMMS PORTS	1-10
• DIGITAL INPUT	1-12
• DIGITAL OUTPUT	1-13
• DISPLAY/KEYPAD	1-14
• FEEDBACKS	1-15
• FLUXING	1-16
• MINIMUM SPEED	1-19
• MMI ACCESS	1-20
• MOTOR DATA	1-21
• PATTERN GEN	1-22
• PID	1-23
• PRESET	1-25
• RAISE/LOWER	1-27
• REFERENCE	1-28
• REFERENCE JOG	1-30
• REFERENCE RAMP	1-31
• REFERENCE STOP	1-32
• SEQUENCING LOGIC	1-33
• SKIP FREQUENCIES	1-35
• TRIPS STATUS	1-37

Chapter 2 PARAMETER SPECIFICATION

Specification Table: Tag Number Order	2-1
Specification Table: Pref Order	2-6
Specification Table: MMI Name Order	2-10
Product-Related Default Values	2-12
* Frequency Dependent Defaults	2-12
** Power Dependent Defaults	2-12

Contents

Contents

Page

Chapter 3 SERIAL COMMUNICATIONS

Communications Technology Options..... 3-1

Connection to the P3 Port 3-1

Chapter 4 SEQUENCING LOGIC

Principle State Machine 4-1

Main Sequencing States..... 4-1

State Outputs of the SEQUENCING LOGIC Function Block 4-1

Transition of States..... 4-2

State Diagram 4-3

External Control of the Drive 4-4

Communications Command..... 4-4

- Example Commands..... 4-5

Communications Status 4-6

Chapter 5 APPLICATIONS

The Default Application 5-1

How to Load an Application 5-1

Application Description 5-1

Application 1 : Basic Speed Control (default) 5-3

Application 2 : Auto/Manual Control 5-5

Application 3 Preset Speeds 5-7

Application 4 : Raise/Lower Trim..... 5-9

Application 5 : PID 5-11

Application Control Blocks..... 5-13

PROGRAMMING YOUR APPLICATION

You can program the drive to your specific application. This programming simply involves changing parameter values. Access the parameters using the keypad.

Each Application recalls a pre-programmed set of default parameters and links when it is loaded.

Refer to Chapter 5: “Applications” for further information.

Each Application is represented as a block diagram, consisting of *function blocks* and *links*:

- Each function block contains the parameters required for setting-up a particular processing feature. Sometimes more than one instance of a function block is provided for a feature, i.e. for multiple digital inputs.
- Software links are used to connect the function blocks. Each link transfers the value of an output parameter to an input parameter of another (or the same) function block.

Each individual block is a processing feature, i.e. it takes the input parameter, processes the information, and makes the result available as one or more output parameters.

Modifying a Block Diagram Over Comms

The drive can be running or stopped. Note that some parameters can only be changed when the drive is stopped. It is not possible to modify the drive's internal links.

Execution Rules

The complete block diagram is executed every 10ms. Just before a function block is executed, all the links that have that block as their destination are executed, thereby copying new values into the block's parameter inputs. The input parameters are then processed to produce a new set of output parameters. The execution order of the blocks is automatically arranged for minimal delay.

- The output value transferred by a link on execution is clamped to be between the maximum and minimum value for its destination input parameter.
- Refer to the table below for the result of linking different parameter types.

Source Value (the input)	Source Type	Destination Type	Destination Value (the result)
TRUE	Boolean	Real	0.01
FALSE	Boolean	Real	0.00
≥ 0.005	Real	Boolean	TRUE
≤ 0.005	Real	Boolean	FALSE
LOCAL ONLY (1)	Enumerated	Real	1.00
2.00	Real	Enumerated	REMOTE ONLY (2) (Note that (2) will not always return Remote Only)

Table 1-1 Execution Rules

Saving Your Modifications

Whenever a value is changed using keypad, the modification is stored automatically and will be saved on power-down.

When a value is changed via the comms, it is necessary to issue a save command or the value will be lost on power-down. Refer to the RS485/RS232 Comms Interface Technical Manual, HA466357U001 (Save Command).

1-2 Programming Your Application

Function Block Descriptions

Note: To view all parameters available on the MMI, Full menu detail must be selected in the DETAILED MENUS parameter (^{ST99}). Additional blocks/parameters are available over the Comms.

Understanding the Function Block Description

The following function blocks show the parameter information necessary for programming the drive.

Input parameters are shown on the left hand side, and output parameters are shown on the right hand side of the block.

The diagrams assume that the UK country code is selected and that a 400V 11kW Frame C power board is fitted. This is reflected in the values of certain parameters, see “*” and “**” in the table below.

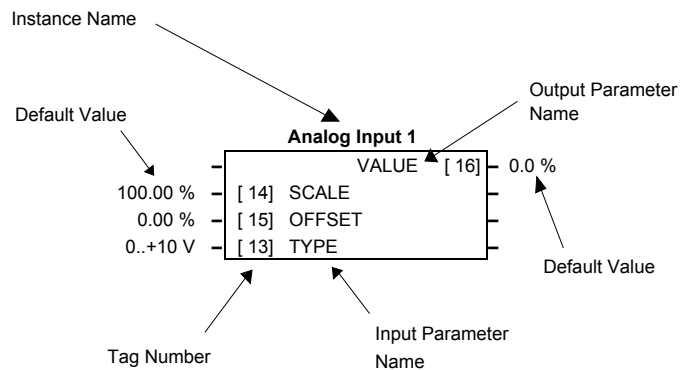

Figure 1-1 Function Block Parameter Information

Instance Name	Names the function block and MMI menu
Default Value	The default value for the NULL application. This may be different for other Applications
Input/Output Parameter Name	The parameter name.
Tag Number	Unique identification used for communications
*	Parameters marked with “*” are set to a value depending upon the “operating frequency” of the drive. Refer to Chapter 2: “Parameter Specification” - Frequency Dependent Defaults; and the Installation Product Manual, Chapter 5: “The Operator Station” - Changing the Product Code (3-button reset).
**	Parameters marked with “**” are set to a value depending on the overall “power build ” of the drive indicated by the product code. Refer to Chapter 2: “Parameter Specification” - Power Dependent Defaults; and the Installation Product Manual: Chapter 2: “Understanding the Product Code”.

Note: The “Range” for a parameter value is given in the Parameter Description Table on each Function Block page. Ranges for outputs are given as “—.xx %”, for example, indicating an indeterminate integer for the value, to two decimal places.

F	Parameters indicated with F are visible with Full menus only. Refer to the DETAILED MENUS parameter (^{ST99}) in the MMI ACCESS function block, page 1-20.
M	Parameters indicated with M are Motor Parameters. They are not reset by changing Application using parameter ^{P1} ; all other parameters are reset to default values.

Function Blocks by Category

The function block descriptions in this chapter are arranged in alphabetical order, however, they are listed below by Category.

Communications

COMMS PORTS 1-10

Configuration

APP CONFIG 1-7

Inputs/Outputs

ANALOG INPUT	1-4	DIGITAL INPUT	1-12
ANALOG OUTPUT	1-6	DIGITAL OUTPUT	1-13

Menus

DISPLAY/KEYPAD	1-14	MMI ACCESS	1-20
----------------	------	------------	------

Motor Control

FEEDBACKS	1-15	MOTOR DATA	1-20
FLUXING	1-16	PATTERN GEN	1-22

Sequencing and Referencing

AUTO RESTART	1-8	REFERENCE JOG	1-30
COMMS CONTROL	1-9	REFERENCE RAMP	1-31
REFERENCE	1-28	REFERENCE STOP	1-32
		SEQUENCING LOGIC	1-33

Setpoint Functions

MINIMUM SPEED	1-19	RAISE/LOWER	1-27
PID	1-23	SKIP FREQUENCIES	1-35
PRESET	1-25		

Trips

TRIPS STATUS 1-37

Function Blocks in Alphabetical Order

ANALOG INPUT

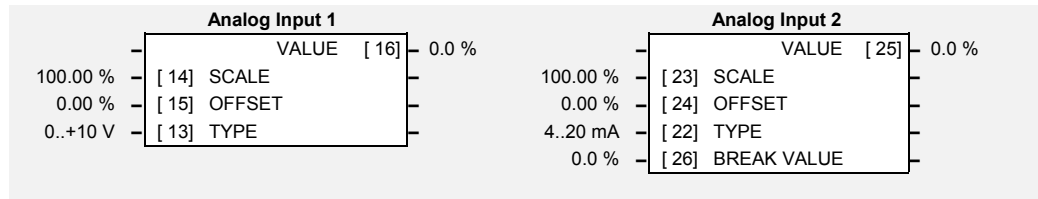

The analog input block converts the input voltage or current into a value expressed as a percentage of a configurable range.

Parameter Descriptions

SCALE *SET/IN IP11 & IP21* *Range: -300.00 to 300.00 %*

A scaling factor applied to the raw input. With a scaling factor of 100.00% and an offset of 0.00%, an input equal to the low input range will appear as a value of 0.00%. Similarly, an input equal to the high input range will appear as a value of 100.00%.

OFFSET *SET/IN IP12 & IP22* *Range: -300.00 to 300.00 %*

An offset added to the input after the scaling factor has been applied.

TYPE *SET/IN IP13 & IP23* *Range: Enumerated - see below*

The input range and type.

ANALOG INPUT 1 supports Types 0 and 1 only. ANALOG INPUT 2 support all types.

Enumerated Value : Type

- 0 : 0..+10 V
- 1 : 0..+5 V
- 2 : 0..20mA
- 3 : 4..20mA

BREAK VALUE *Range: -100.0 to 100.0 %*

The value that will appear as the VALUE output when BREAK is TRUE

VALUE *SET/IN IPA1 & IPA2* *Range: —.x %*

The input reading with scaling and offset applied.

Functional Description

The drive has two analog inputs. There is an analog input function block for each:

ANALOG INPUT 1 is associated with the signal on terminal 2

ANALOG INPUT 2 is associated with the signal on terminal 3

The input voltage is pre-processed and converted into a numeric value by the analog input electronics of the drive. The analog input function blocks further process this reading so that a value of 0.00% represents an input equal to the low input range, while a value of 100.00% represents an input equal to the high input range. The SCALE and OFFSET factors are then applied as shown to produce a value suitable for use in the application.

The break detect facility is only used in conjunction with the "4 to 20mA" hardware range. An input break is defined as an input reading less than either 0.1V or 0.45mA. When an input break has been detected, the VALUE output is forced to be the BREAK VALUE.

If you don't want the break detect facility, select the "0 to 20mA". You can also apply OFFSET to recreate the "4 to 20mA" hardware range.

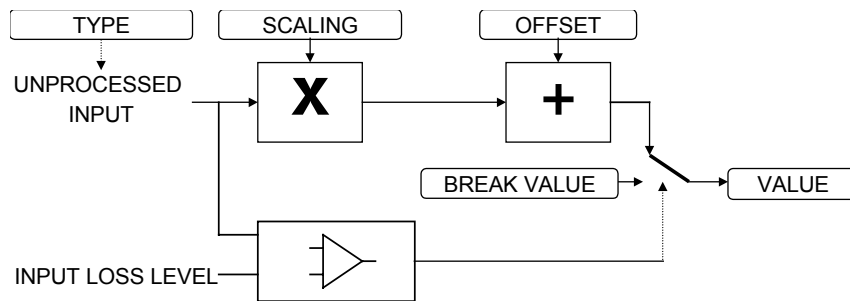

1-6 Programming Your Application

ANALOG OUTPUT

The analog output block converts the demand percentage into a form suitable for driving the analog output electronics of the drive.

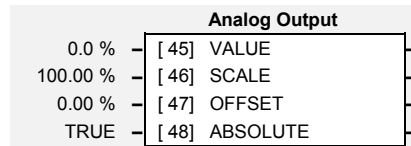

Parameter Descriptions

VALUE *SET/OUT OP05* *Range: -300.0 to 300.0 %*
The demanded value to output.

SCALE *SET/OUT OP02* *Range: -300.00 to 300.00 %*
A scaling factor to apply to VALUE . A scaling factor of 100.00% has no effect.

OFFSET *SET/OUT OP03* *Range: -300.00 to 300.00 %*
An offset added to VALUE after the scaling factor has been applied. An offset factor of 0.00% has no effect.

ABS *SET/OUT OP04* *Range: FALSE / TRUE*
When TRUE the output sign is ignored.

Functional Description

The drive has one analog outputs:

ANALOG OUTPUT 1 is associated with terminal 5

The scaling and offset parameters are applied to the demand value as shown.

If ABS is TRUE then the final output is the magnitude of value after being scaled and offset and the output sign is ignored

If ABS is FALSE then as above, except that the output sign is valid.

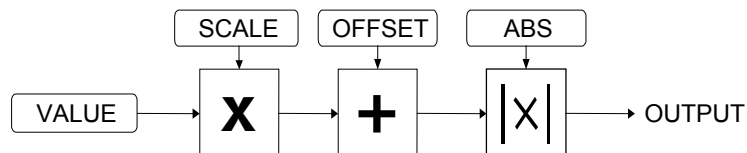

APP CONFIG

This block controls the selection of user application and of the output wiring

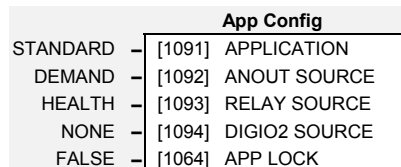

Parameter Descriptions

APPLICATION *PAR\PI* *Range: Enumerated - see below*

This parameter selects and loads the Application to be used. APP 0 will not control a motor. APP 6, 7, 8 & 9 are reserved for SSD Drives.

Refer to Chapter 5: "Applications" which gives detailed information about each Application.

- 0 : NULL
- 1 : STANDARD
- 2 : LOCAL/REM (AUTO/MANUAL)
- 3 : PRESETS
- 4 : RAISE/LOWER
- 5 : PID
- 6 : APP 6
- 7 : APP 7
- 8 : APP 8
- 9 : CUSTOM

ANOUT SOURCE *SET/OUT OP01* *Range: Enumerated - see below*

The source of the analog output, terminal 5. An internal link is made to one of the following parameters:

- 0 : NONE *No link is made*
- 1 : DEMAND *SPEED DEMAND in the REFERENCE block*
- 2 : CURRENT *MOTOR CURRENT% in the FEEDBACKS block*
- 3 : PID ERROR *ERROR in the PID Block*
- 4 : R/L OUTPUT *OUTPUT in the RAISE/LOWER block*

RELAY SOURCE *SET/OUT OP31* *Range: Enumerated - see below*

The source of the relay output, terminals RL1A and RL1B. An internal link is made to one of the following parameters:

- 0 : NONE *No link is made*
- 1 : HEALTH *HEALTHY in the SEQ LOGIC block*
- 2 : TRIPPED *TRIPPED in the SEQ LOGIC block*
- 3 : RUNNING *RUNNING in the SEQ LOGIC block*
- 4 : AT ZERO *AT ZERO SPD in the ZERO SPEED block*
- 5 : AT SPEED *AT SPEED in the AT SPEED block*

DIGIO2 SOURCE *SET/OUT OP21* *Range: Enumerated - see below*

The source of the digital output 2, terminal 10. An internal link is made to one of the following parameters:

- 0 : NONE *No link is made*
- 1 : HEALTH *HEALTHY in the SEQ LOGIC block*
- 2 : TRIPPED *TRIPPED in the SEQ LOGIC block*
- 3 : RUNNING *RUNNING in the SEQ LOGIC block*
- 4 : AT ZERO *AT ZERO SPD in the ZERO SPEED block*
- 5 : AT SPEED *AT SPEED in the AT SPEED block*

APP LOCK *SET\SETP ST98* *Range: FALSE / TRUE*

Set this parameter to TRUE to prevent the APPLICATION parameter from being edited.

1-8 Programming Your Application

AUTO RESTART

Auto Restart (or Auto Reset) provides the facility to automatically reset a choice of trip events and restart the drive with a programmed number of attempts, after which, a manual or remote trip reset is required if the drive is not successfully restarted. The number of attempted restarts are recorded. This count is cleared after a trip-free period of operation (5 minutes or 4 x ATTEMPT DELAY 1, whichever is the longer), or after a successful manual or remote trip reset, or by removing the Run signal.

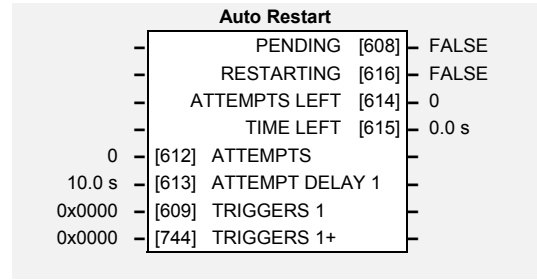

In addition, if the POWER UP START parameter in the SEQUENCING LOGIC function block is True, then the Auto Restart feature will also operate even if the trip initially occurs when the drive is not running (as long as the Run signal remains True).

Parameter Descriptions

ATTEMPTS SET\SETP ST21 *Range: 0 to 10*
 Determines the number of restarts that will be permitted before requiring an external fault reset.

ATTEMPT DELAY 1 SET\SETP ST22 *Range: 0.0 to 600.0 s*
 Determines the delay between restart attempts for a trip included in TRIGGERS 1. The delay is measured from all error conditions clearing.

TRIGGERS 1 and TRIGGERS+ 1 SET\SETP ST23 and SET\SETP ST24 *Range: 0000 to FFFF*
 Allows Auto Restart to be enabled for a selection of trip conditions.

Refer to TRIPS STATUS, page 1-37 for an explanation of the four-digit codes.

PENDING *Range: FALSE / TRUE*
 Indicates that an auto restart will occur after the programmed delay.

RESTARTING *Range: FALSE / TRUE*
 Indicates that an auto restart is occurring. TRUE for a single block diagram execution cycle.

ATTEMPTS LEFT *Range: —.*
 Indicates the number of attempts left before an external fault reset is required.

TIME LEFT *Range: —.x s*
 When in the Restarting state, this parameter indicates the time left before an auto restart attempt will be permitted. When non-zero, this value is unaffected by changes to ATTEMPT DELAY 1.

COMMS CONTROL

This block switches between Remote Terminal and Remote Comms operating modes.

The drive must be in Remote mode for selection to be made - REMOTE mode is enabled in the LOCAL CONTROL function block (REF MODES) and selected by the keypad. Refer to the outputs of the LOCAL CONTROL function block for the mode in use.

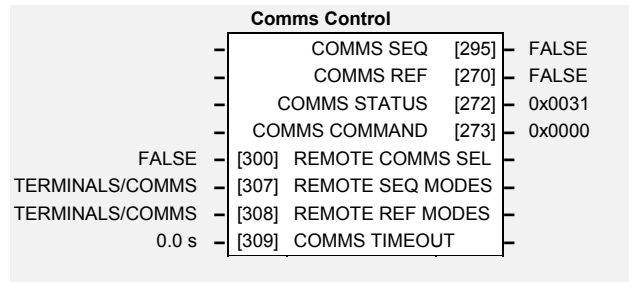

Parameter Descriptions

REMOTE COMMS SEL SET\SERL SE01 *Range: FALSE / TRUE*

Selects the type of remote communications mode:

0 : FALSE, and in REMOTE mode then control is from the terminals.

1 : TRUE, and in REMOTE mode then control is from the communications.

REMOTE SEQ MODES *Range: Enumerated - see below*

Selects the type of remote sequencing mode:

Enumerated Value : Mode

0 : TERMINALS/COMMS

1 : TERMINALS ONLY

2 : COMMS ONLY

REMOTE REF MODES *Range: Enumerated - see below*

Selects the type of remote reference mode:

Enumerated Value : Mode

0 : TERMINALS/COMMS

1 : TERMINALS ONLY

2 : COMMS ONLY

COMMS TIMEOUT SET\SERL SE02 *Range: 0.0 to 600.0 s*

Sets the maximum time allowed between refreshing the COMMS COMMAND parameter. The drive will trip if this time is exceeded. Set the time to 0.00 seconds to disable this feature.

COMMS SEQ *Range: FALSE / TRUE*

Diagnostic indicating if operating in Remote Sequencing Comms Mode.

If FALSE (0), the drive may be in Local Sequencing mode or Remote Sequencing Terminal mode.

COMMS REF *Range: FALSE / TRUE*

Diagnostic indicating if operating in Remote Reference Comms Mode.

If FALSE (0), the drive may be in Local Reference mode or Remote Reference Terminal mode.

COMMS STATUS *Range: 0000 to FFFF*

Diagnostic showing the 16-bit Status word as seen by the communications.

Refer to Chapter 4: "Sequencing Logic".

COMMS COMMAND *Range: 0000 to FFFF*

Diagnostic showing the 16-bit Command as written by the communications.

Refer to Chapter 4: "Sequencing Logic".

1-10 Programming Your Application

COMMS PORTS

This function block configures the programming ports that allow connection to the keypad, or to a personal computer.

The parameters below are used to identify the drive to the controlling software for drive configuration and storage of parameters.

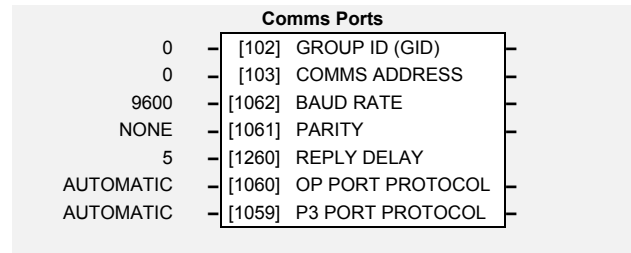

Parameter Descriptions

GROUP ID (GID)

Range: 0 to 7

The SSD Drives protocol group identity address.

COMMS ADDRESS

SET\SERL SE03

Range: 0 to 255

The SSD Drives protocol unit identity address (UID) or the Modbus node address. Note: if set to 0, it will only respond to broadcast messages.

BAUD RATE

SET\SERL SE04

Range: Enumerated - see below

Selects the Baud Rate for the MODBUS protocol.

Enumerated Value : Baud Rate

- 0 : 1200
- 1 : 2400
- 2 : 4800
- 3 : 7200
- 4 : 9600
- 5 : 14400
- 6 : 19200
- 7 : 38400
- 8 : 57600

PARITY

SET\SERL SE05

Range: Enumerated - see below

Selects the Parity for the MODBUS protocol.

Enumerated Value : Parity

- 0 : NONE
- 1 : ODD
- 2 : EVEN

REPLY DELAY

SET\SERL SE06

Range: 0 to 200 ms

The time in milliseconds between the drive receiving the complete request from the communications master (PLC/PC) and replying to this request.

OP PORT PROTOCOL

SET\SERL SE07

Range: Enumerated - see below

Selects the protocol to be used by the keypad port on the front of the drive. When EIBISYNC ASCII is selected, BAUD RATE is 19200 and PARITY is EVEN.

Enumerated Value : Protocol

- 0 : AUTOMATIC - checks for keypad or EI ASCII
- 1 : KEYPAD
- 2 : EIBISYNC ASCII
- 3 : MODBUS
- 4 : FIELDBUS (reserved for future use)

P3 PORT PROTOCOL **F** SET\SERL SE08 *Range: Enumerated - see below*

Selects the protocol to be used by the RS232 programming port on the drive's control board.
When EIBISYNC ASCII is selected, BAUD RATE is 19200 and PARITY is EVEN.

Enumerated Value : Protocol

- 0 : AUTOMATIC - checks for keypad or EI ASCII
- 1 : KEYPAD
- 2 : EIBISYNC ASCII
- 3 : MODBUS
- 4 : FIELDBUS (reserved for future use)

Functional Description

When communicating using the EI BISYNC ASCII protocol, the unit will always respond to GID = 0 and UID = 0, as this is the broadcast address used by the 6901 keypad.

1-12 Programming Your Application

DIGITAL INPUT

The digital input block converts the physical input voltage to TRUE or FALSE control signals.

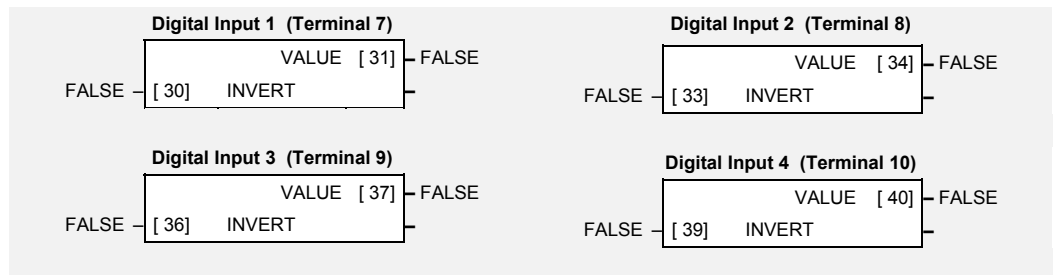

Functional Description

There is a DIGITAL INPUT function block associated with each of the following terminals:

The Control Board has four configurable digital inputs:

- DIGITAL INPUT 1 is associated with terminal 7
- DIGITAL INPUT 2 is associated with terminal 8
- DIGITAL INPUT 3 is associated with terminal 9
- DIGITAL INPUT 4 is associated with terminal 10 (shares terminal with DOUT2)

Parameter Descriptions

INVERT	SET/IN IP01 to IP04	Range: FALSE / TRUE
Controls the optional inversion of the VALUE output.		
VALUE	SET/IN IPD1 to IPD4	Range: FALSE / TRUE
The TRUE or FALSE input, (after any inversion).		

DIGITAL OUTPUT

The digital output block converts a logic TRUE or FALSE demand to a physical output signal.

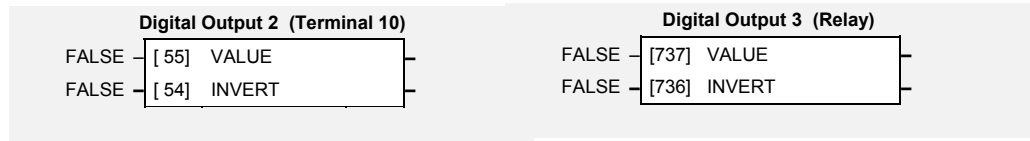

Parameter Descriptions

VALUE SET/OUT OP23 - DOUT2 *Range: FALSE / TRUE*
 SET/OUT OP33 - DOUT3

The TRUE or FALSE output demand.

INVERT *SET/OUT OP22 - DOUT2* *Range: FALSE / TRUE*
SET/OUT OP32 - DOUT3

Controls the optional inversion of the VALUE output.

Functional Description

There is a DIGITAL OUTPUT function block associated with each of the following terminals:

The Control Board has three digital outputs (volt-free relay contacts):

DIGITAL OUTPUT 2 is associated with terminal 10 (shares terminal with DIN4)

DIGITAL OUTPUT 3 is associated with terminals RL1A and RL1B (user relay)

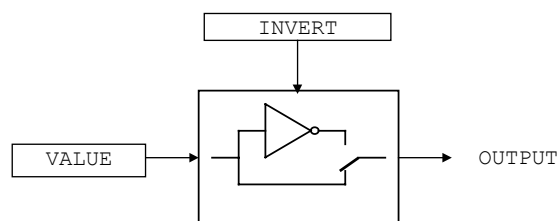

1-14 Programming Your Application

DISPLAY/KEYPAD

This function block provides information about the keypad connected to the drive and can be used to customise the keypad control keys.

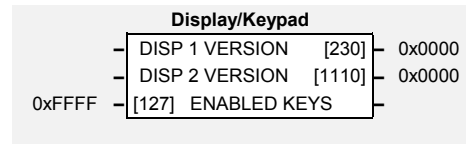

Parameter Descriptions

ENABLED KEYS SET\SETP ST52 Range: 0000 to FFFF

The following keys on the 6901 keypad can be enabled or disabled separately. The combination produces the parameter setting as in the table below. The default of 0xFFFF enables all keys.



6901

Parameter Setting	RUN	L/R	JOG	DIR
0000	-	-	-	-
0010	-	-	-	ENABLED
0020	-	-	ENABLED	-
0030	-	-	ENABLED	ENABLED
0040	-	ENABLED	-	-
0050	-	ENABLED	-	ENABLED
0060	-	ENABLED	ENABLED	-
0070	-	ENABLED	ENABLED	ENABLED
0080	ENABLED	-	-	-
0090	ENABLED	-	-	ENABLED
00A0	ENABLED	-	ENABLED	-
00B0	ENABLED	-	ENABLED	ENABLED
00C0	ENABLED	ENABLED	-	-
00D0	ENABLED	ENABLED	-	ENABLED
00E0	ENABLED	ENABLED	ENABLED	-
00F0	ENABLED	ENABLED	ENABLED	ENABLED



6511



6521

When using the standard 6511 and 6521 keypad, disabling the **DIR** key prevents the local setpoint going negative (for reverse). Similarly, disabling the **L/R** key prevents the drive being changed from Local to Remote, or Remote to Local modes.

DISP 1 VERSION Range: 0000 to FFFF

This is the software version of the keypad connected to the keypad port on the front of the drive.

DISP 2 VERSION Range: 0000 to FFFF

This is the software version of the keypad connected to the RS232 programming port. This port is located on the control board inside the drive.

FEEDBACKS

The FEEDBACKS block allows you to view motor current related diagnostics.

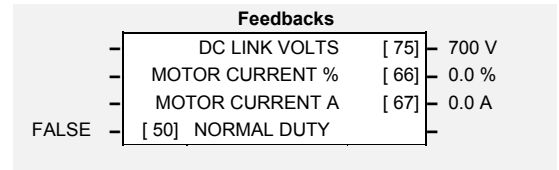

Parameter Descriptions

NORMAL DUTY was previously referred to as Quadratic Torque in past Eurotherm Drives' manuals.

NORMAL DUTY *PAR\ P12* *Range: FALSE/TRUE*

When TRUE, selects NORMAL DUTY allowing higher continuous ratings with less overload capability. This is especially suited to fan or pump applications.

When FALSE, selects HEAVY DUTY.

DC LINK VOLTS *DIAG 3* *Range: —. V*

This diagnostic shows the voltage on the dc link capacitors.

MOTOR CURRENT % *Range: —.xx %*

Contains the level of rms line current being drawn from the drive and is seen as a % of the MOTOR CURRENT parameter setting in the MOTOR DATA function block.

MOTOR CURRENT A *DIAG 4* *Range: —.xx A*

This diagnostic contains the level of rms line current being drawn from the drive.

1-16 Programming Your Application

FLUXING

This function block allows user parameterisation of the conventional (volts/hertz) fluxing strategy of the drive. This is achieved through two flexible Volts-to-frequency templates. Starting torque performance can also be tailored through the FIXED BOOST and AUTO BOOST parameters.

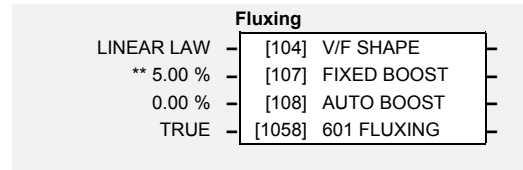

Parameter Descriptions

V/F SHAPE

PAR\ P11

Range: Enumerated - see below

This parameter determines the type of volts to frequency template is used to flux the motor. The choices of this parameter are:

Enumerated Value : V/F Shape

0 : LINEAR LAW

1 : FAN LAW

LINEAR LAW : This gives a constant flux characteristic up to the BASE FREQUENCY

FAN LAW: This gives a quadratic flux characteristic up to the BASE FREQUENCY. This matches the load requirement for fan and most pump applications

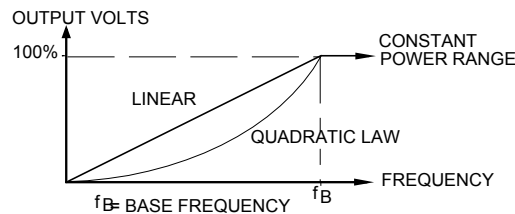

FIXED BOOST

PAR\ P13

Range: 0.00 to 25.00 %

This parameter allows for no-load stator resistance voltage drop compensation. This correctly fluxes the motor (under no-load conditions) at low output frequencies, thereby increasing available motor torque. Fixed boost can be set in addition to auto boost.

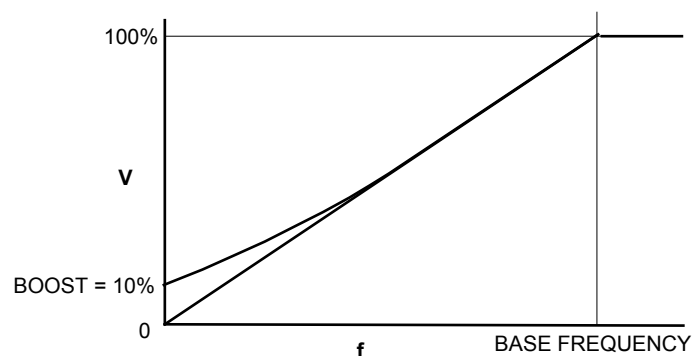

AUTO BOOST

Range: 0.00 to 25.00 %

This parameter allows for load dependent stator resistance voltage drop compensation. This correctly fluxes the motor (under load conditions) at low output frequencies, thereby increasing available motor torque. Auto boost can be set in addition to fixed boost.

The value of the AUTO BOOST parameter determines level of additional volts supplied to the motor for 100% load.

Setting the value of auto boost too high can cause the drive to enter current limit. If this occurs, the drive will be unable to ramp up in speed. Reducing the value of auto boost will eliminate this problem.

601 FLUXING (BOOST MODE)

Range: FALSE / TRUE

Determines the relationship between fixed boost and terminal volts. There are two settings:

FALSE produces the terminal volts profile shown below (with Auto Boost set to 0.0 %). In this mode AUTO BOOST should be set to provide optimum low speed performance.

TRUE emulates the terminal volts profile provided by the SSD Drives' 601 product. This allows drop in replacement of the 601 by the 650. AUTO BOOST has no effect in this mode.

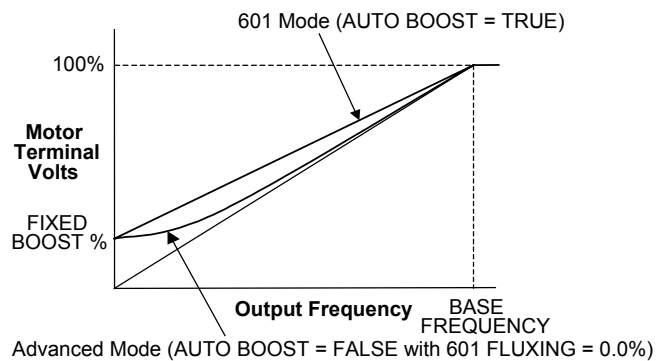

1-18 Programming Your Application

Functional Description

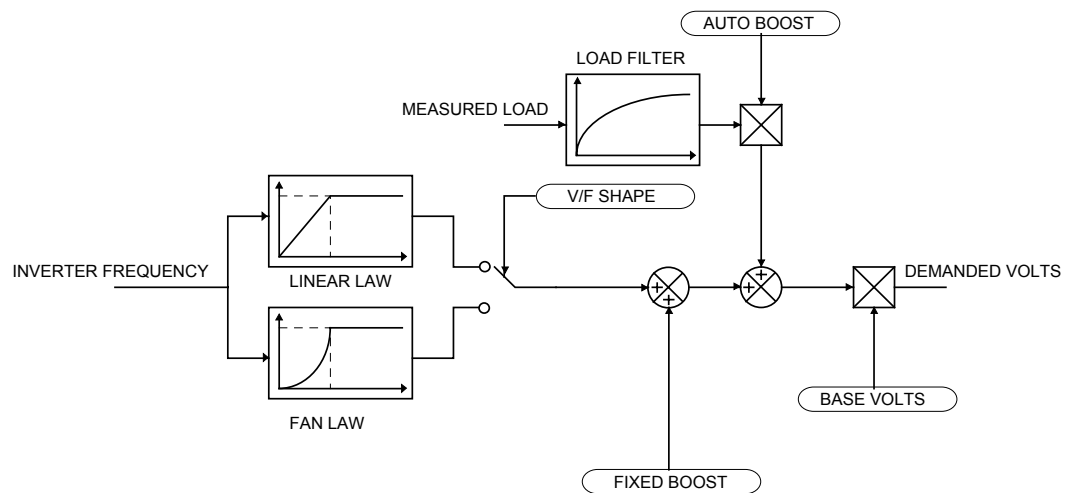

The function block allows the user to parameterise the drive's conventional V/F motor fluxing scheme. Two V/F shapes are available, LINEAR LAW and FAN LAW:

- Linear Law V/F shape should be used in applications requiring constant motor torque though out the speed range (e.g. machine tools or hoists).
- Fan Law V/F shape provides extra energy savings for fan or pump applications.

Correct no-load motor fluxing at low drive output frequencies can be achieved by setting the FIXED BOOST parameter.

Correct motor fluxing under load conditions is achieved by setting the AUTO BOOST parameter.

MINIMUM SPEED

The minimum speed block is used to determine how the drive will follow a reference. There are two modes

1. Proportional : minimum limit
2. Linear : between minimum and maximum.

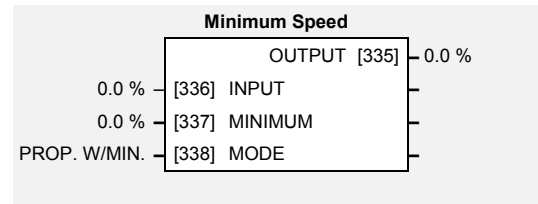

Parameter Descriptions

INPUT

The input for this block.

Range: -300.0 to 300.0 %

MINIMUM

PAR\ P3

This parameter determines the minimum output value from this block

Range: -100.0 to 100.0 %

MODE

SET\SETP ST06

This parameter represents the operating mode of the block. There are two modes:

Range: Enumerated - see below

Enumerated Value : Operating Mode

0 : PROP. W/MIN.

1 : LINEAR

OUTPUT

The output is determined by the MODE selected, see below.

Range: —.x %

Functional Description

There are two operating modes for the MINIMUM SPEED block:

Proportional with Minimum

In this mode the MINIMUM SPEED block behaves like a simple clamp. The minimum value has the valid range -100% to 100% and the output is always greater than or equal to the minimum value.

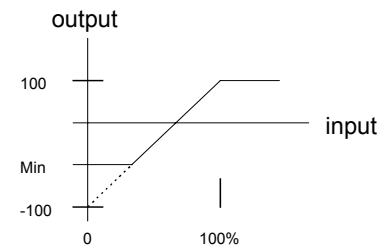

Linear

In this mode the MINIMUM SPEED block first clamps the input to zero then rescales the input such that the output goes linearly between minimum and 100% for an input that goes from 0 to 100%.

Note the constraints:-

- min \geq 0
- input \geq 0
- max = 100%

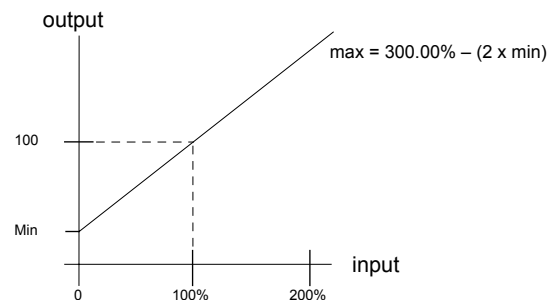

1-20 Programming Your Application

MMI ACCESS

This function block contains options associated with operator station password protection and the amount of detail the menu structure will show.

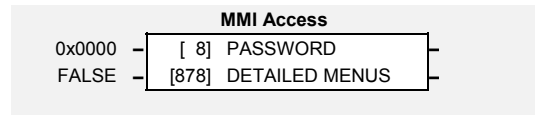

Parameter Descriptions

PASSWORD *PAR\ P99* *Range: 0000 to FFFF*

Setting a non-zero value enables the password feature.

DETAILED MENUS *SET\SETP ST99* *Range: FALSE / TRUE*

Selects Full menu detail for the keypad. The additional parameters shown in the menus are indicated in this manual by **F**.

MOTOR DATA

In this function block you enter the details of the motor under control and any available motor nameplate information.

The Autotune feature will determine the MAG CURRENT motor model parameter.

Motor Data		
* 50.0 Hz	[1159]	BASE FREQUENCY
230.0 V	[1160]	MOTOR VOLTAGE
** 1.50 A	[64]	MOTOR CURRENT
0.80 A	[65]	MAG CURRENT
1380.0 rpm	[83]	NAMEPLATE RPM
4 POLE	[84]	MOTOR POLES

Parameter Descriptions

BASE FREQUENCY  PAR\ P7

Range: 25.0 to 240.0Hz

This parameter contains the motor nameplate base frequency. Refer to FLUXING, page 1-16.

MOTOR VOLTAGE

Range: 0.0 to 575.0V

This parameter contains the motor nameplate voltage at base frequency. Refer to **Error! Reference source not found.**, page 1-**Error! Bookmark not defined.**

MOTOR CURRENT  PAR\ P6

Range: 0.01 to 999.99A

This parameter contains the motor nameplate full-load line current.

MAG CURRENT

Range: 0.01 to 999.99A

This parameter contains the motor model no-load line current as determined by the Autotune, or from the motor nameplate.

NAMEPLATE RPM

Range: 0.1 to 30000.0 rpm

This parameter contains the motor nameplate full-load rated speed. This is the motor speed in rpm at base frequency minus full load slip.

MOTOR POLES

Range: Enumerated - see below

This parameter contains the motor nameplate pole-pairs.

Enumerated Value : Motor Poles

- 2 : 2 pole
- 4 : 4 pole
- 6 : 6 pole
- 8 : 8 pole
- 10 : 10 pole
- 12 : 12 pole

1-22 Programming Your Application

PATTERN GEN

The pattern generator function block allows you to configure the drive PWM (Pulse Width Modulator) operation.

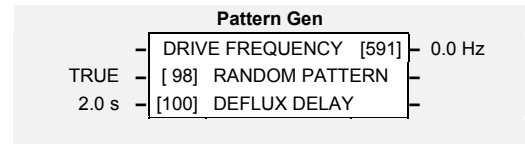

Parameter Descriptions

RANDOM PATTERN

Range: FALSE / TRUE

This parameter selects between random pattern (quiet motor noise) or the more conventional fixed carrier PWM strategies. When TRUE, random pattern is enabled.

DEFLUX DELAY

Range: 0.1 to 10.0 s

Sets the minimum allowed delay between disabling and then re-enabling PWM production (i.e. stopping and starting the drive).

DRIVE FREQUENCY *DIAG 1*

Range: —.x Hz

This indicates the drive output frequency.

Functional Description

The drive provides a unique quiet pattern PWM strategy in order to reduce audible motor noise. The user is able to select between the quiet pattern or the more conventional fixed carrier frequency method. With the quiet pattern strategy selected (random pattern enabled), audible motor noise is reduced to a dull hiss.

PID

This function block allows the drive to be used in applications requiring a trim to the setpoint, depending on feedback from an external measurement device. Typically this will be used for process control, i.e. pressure or flow.

PID	
OUTPUT	[1256] 0.00 %
ERROR	[619] 0.00 %
LIMITING	[1257] FALSE
0.00 %	[1247] SETPOINT
0.00 %	[617] FEEDBACK
0.00 %	[1248] FEED FWD
1.00	[618] FEEDBACK GAIN
0.00	[1249] FEED FWD GAIN
0.10	[1250] P GAIN
1.00	[1251] I GAIN
0.00	[1252] D GAIN
300.00 %	[1253] LIMIT
FALSE	[1254] ENABLE PID
FALSE	[1098] INTEGRAL DEFEAT
0.05 s	[1255] D FILTER TC
1.0000	[1258] OUTPUT SCALING

Parameter Descriptions

SETPOINT

The input setpoint to the PID block.

Range: -300.00 to 300.00 %

FEEDBACK

The feedback input to the PID block.

Range: -300.00 to 300.00 %

FEED FWD

The feed forward input to the PID block.

Range: -300.00 to 300.00 %

FEEDBACK GAIN PAR\ P505

The feedback gain of the PID block.

Range: -10.00 to 10.00

FEED FWD GAIN

The feed forward gain of the PID block.

Range: -10.00 to 10.00

P GAIN *PAR\ P501*

The Proportional gain of the PID block.

Range: 0.00 to 100.00

I GAIN *PAR\ P502*

The Integral gain of the PID block.

Range: 0.00 to 100.00

D GAIN PAR\ P503

The Derivative gain of the PID block.

Range: 0.00 to 100.00

LIMIT PAR\ P506

This parameter determines the maximum positive and negative limits of the PID output.

Range: 0.00 to 300.00 %

ENABLE PID

When TRUE, the PID output operates normally; when FALSE, the output is zero and the integral term is reset to zero.

Range: FALSE / TRUE

INTEGRAL DEFEAT

This parameter resets the integral term to zero when TRUE.

Range: FALSE / TRUE

D FILTER TC PAR\ P504

In order to help attenuate high frequency noise on the PID output, a first order output filter has been provided. This parameter determines the output filter time constant.

Range: 0.05 to 5.00 s

1-24 Programming Your Application

OUTPUT PAR\ P509 Range: xx.xx %
 The output of the PID function.

ERROR PAR\ P508 Range: xx.xx %
 The result of SETPOINT - FEEDBACK x FEEDBACK GAIN.

LIMITING Range: FALSE / TRUE
 This output is TRUE if the output is at the LIMIT value.

OUTPUT SCALING PAR\ P507 Range: -3.0000 to 3.0000
 This parameter represents an overall scaling factor which is applied after the PID positive and negative clamps.

Functional Description

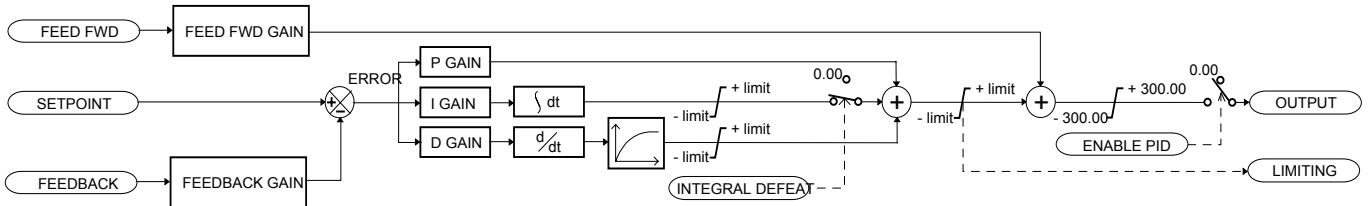

For an application that requires closed loop control, the error term may be derived from the setpoint and feedback using a value function block. This error term is then used by the PID. The output of the PID may be used to trim the demand setpoint via the SPEED TRIM parameter in the REFERENCE function block.

PRESET

This block is used to select a value from one of eight inputs, depending on the value of another input. A second output is provided to allow the block to be used as two banks of four inputs.

The Range of preset inputs is -32768.0 to 32767.

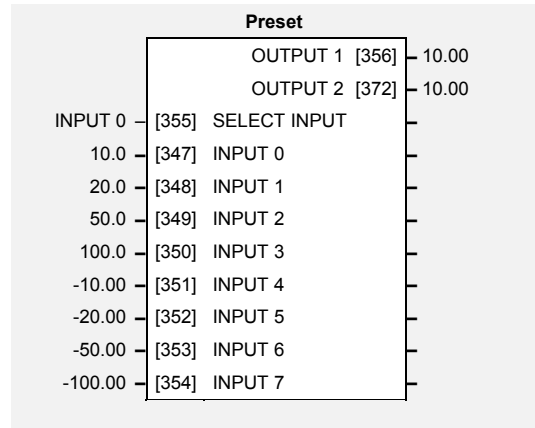

Parameter Descriptions

SELECT INPUT

Range: Enumerated - see below

Determines which of the inputs is routed to OUTPUT 1. In addition, if SELECT INPUT is in the range 0 to 3, INPUT 4 to INPUT 7 respectively is routed to OUTPUT 2.

Enumerated Value : Select Input

- 0 : INPUT 0
- 1 : INPUT 1
- 2 : INPUT 2
- 3 : INPUT 3
- 4 : INPUT 4
- 5 : INPUT 5
- 6 : INPUT 6
- 7 : INPUT 7

INPUT 0 TO INPUT 7

PAR\ P301 to P308

Range: -300.00 to 300.00

Inputs to the Preset block.

OUTPUT 1

Selected input.

Range: — .xx

OUTPUT 2

Selected input (if SELECT INPUT is in the correct range).

Range: — .xx

1-26 Programming Your Application

Functional Description

The Preset function block is a de-multiplexer.

OUTPUT 1 and OUTPUT 2 return the values at selected inputs set by SELECT INPUT.

OUTPUT 2 returns the value of a different input to OUTPUT 1, i.e:

if SELECT INPUT = 0 then OUTPUT 1 = INPUT 0, OUTPUT 2 = INPUT 4

if SELECT INPUT = 1 then OUTPUT 1 = INPUT 1, OUTPUT 2 = INPUT 5 etc.

When SELECT INPUT is set to 4, 5, 6 or 7, OUTPUT 2 will return a value of zero.

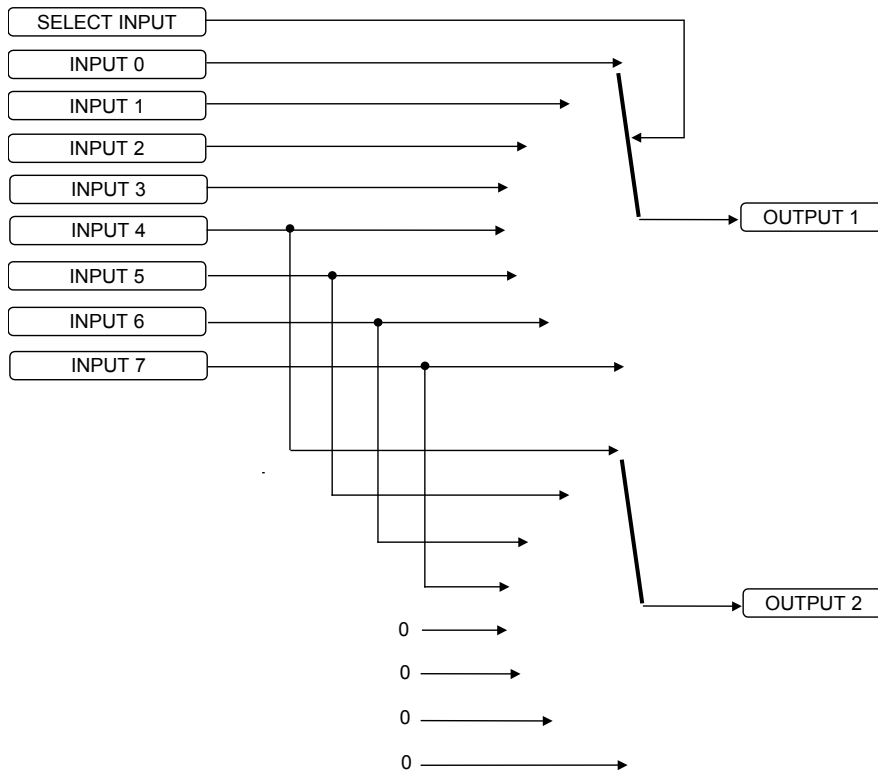

RAISE/LOWER

This function block acts as an internal motorised potentiometer (MOP).

The OUTPUT is preserved during power-down of the drive.

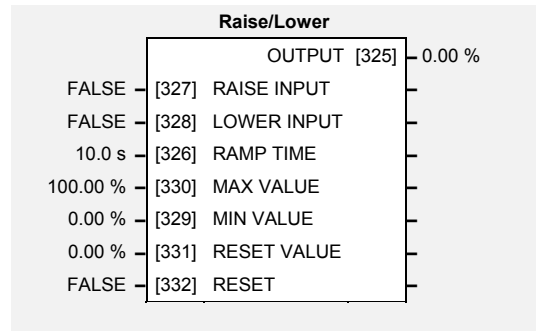

Parameter Descriptions

RAISE INPUT

When TRUE causes OUTPUT to ramp up.

Range: FALSE / TRUE

LOWER INPUT

When TRUE causes OUTPUT to ramp down.

Range: FALSE / TRUE

RAMP TIME

PAR\ P401

Range: 0.0 to 600.0 s

Rate of change of the OUTPUT . Defined as time to change from 0.00% to 100.00% . Note that the raise and lower rates are always the same.

MAX VALUE

PAR\ P402

Range: -100.00 to 100.00 %

The maximum value to which OUTPUT will ramp up to.

MIN VALUE

PAR\ P403

Range: -100.00 to 100.00 %

The minimum value to which OUTPUT will ramp down to.

RESET VALUE

PAR\ P404

Range: -100.00 to 100.00 %

The value the OUTPUT is set to when RESET is TRUE.

RESET

When TRUE, forces OUTPUT to track RESET VALUE .

Range: FALSE / TRUE

OUTPUT

The ramped output. This parameter is persistent, that is, it is saved throughout a power failure.

Range: —.xx %

Functional Description

The table below describes how OUTPUT is controlled by the RAISE INPUT, LOWER INPUT and RESET inputs.

RESET	RAISE INPUT	LOWER INPUT	Action
TRUE	Any	Any	OUTPUT tracks RESET VALUE
FALSE	TRUE	FALSE	OUTPUT ramps up to MAX VALUE at RAMP TIME
FALSE	FALSE	TRUE	OUTPUT ramps down to MIN VALUE at RAMP TIME
FALSE	FALSE	FALSE	OUTPUT not changed. *
FALSE	TRUE	TRUE	OUTPUT not changed. *

* If OUTPUT is greater than MAX VALUE the OUTPUT will ramp down to MAX VALUE at RAMP TIME. If OUTPUT is less than MIN VALUE the OUTPUT will ramp up to MIN VALUE at RAMP TIME.

IMPORTANT: If MAX VALUE is less than MIN VALUE then OUTPUT will be either the MIN VALUE or the MAX VALUE depending on its initial value.

REFERENCE

This function block holds all the parameters concerning the generation of the setpoint reference.

Reference		
	SPEED DEMAND	[255] 0.0 %
	SPEED SETPOINT	[254] 0.0 %
	REVERSE	[256] FALSE
	LOCAL SETPOINT	[247] 0.0 %
	COMMS SETPOINT	[770] 0.0 %
	LOCAL REVERSE	[250] FALSE
0.0 %	[245] REMOTE SETPOINT	
0.0 %	[248] SPEED TRIM	
* 50.0 Hz	[57] MAX SPEED	
110.0 %	[252] MAX SPEED CLAMP	
-110.0 %	[253] MIN SPEED CLAMP	
FALSE	[243] TRIM IN LOCAL	
FALSE	[249] REMOTE REVERSE	
0.0 %	[251] LOCAL MIN SPEED	

Parameter Descriptions

REMOTE SETPOINT

Range: -110.0 to 110.0 %

This is the target reference that the drive will ramp to in remote reference mode (not including trim), direction is taken from REMOTE REVERSE and the sign of REMOTE SETPOINT.

SPEED TRIM

Range: -110.00 to 110.00 %

The trim is added to the ramp output in remote mode (or if TRIM IN LOCAL is TRUE) to form SPEED DEMAND. The trim is typically connected to the output of a PID in a closed loop system. Note that the output of the REFERENCE RAMP block is set to - SPEED TRIM when the drive is started. This ensures that the SPEED DEMAND ramps from zero.

MAX SPEED

M PAR\ P2

Range: 7.5 to 300.0 Hz

The maximum speed of the drive in electrical Hertz (Hz).

MAX SPEED CLAMP

Range: 0.0 to 110.0 %

Maximum value for SPEED DEMAND.

MIN SPEED CLAMP

Range: -110.0 to 0.0 %

Minimum value for SPEED DEMAND.

TRIM IN LOCAL

Range: FALSE / TRUE

When TRUE, SPEED TRIM is always added to the ramp output. When FALSE, SPEED TRIM is added only in Remote mode.

REMOTE REVERSE

Range: FALSE / TRUE

Demanded direction when in Remote Reference mode. This is usually connected directly to the Sequencing Logic.

LOCAL MIN SPEED

F SET\SETP ST51

Range: 0.0 to 100.0 %

The magnitude of the minimum setpoint that will be used when running in Local Mode.

SPEED DEMAND

Range: —.x %

Indicates actual speed demand. This is the input to the frequency controller.

SPEED SETPOINT

DIAG 2

Range: —.x %

This diagnostic indicates target speed. This will be equal to either LOCAL SETPOINT, REMOTE SETPOINT, JOG SETPOINT or COMMS SETPOINT. (Refer to the REFERENCE JOG function block for the JOG SETPOINT parameter).

REVERSE

Range: FALSE / TRUE

Indicates demanded direction. This may not be the actual direction as no account of setpoint sign is taken.

LOCAL SETPOINT

Range: $-.x\%$

Indicates the Operator Station setpoint. It is saved on power down. Direction is taken from LOCAL REVERSE.

COMMS SETPOINT

Range: $-.x\%$

This setpoint is the target reference that the drive will ramp to in Remote Reference Comms mode (not including trim). The direction is always positive, i.e. forward.

Note that this parameter, readable as Tag 770 in the block diagram, is written to using Tag 269.

LOCAL REVERSE

Range: FALSE / TRUE

Indicates demanded direction in Local Reference mode, saved on power-down.

Functional Description

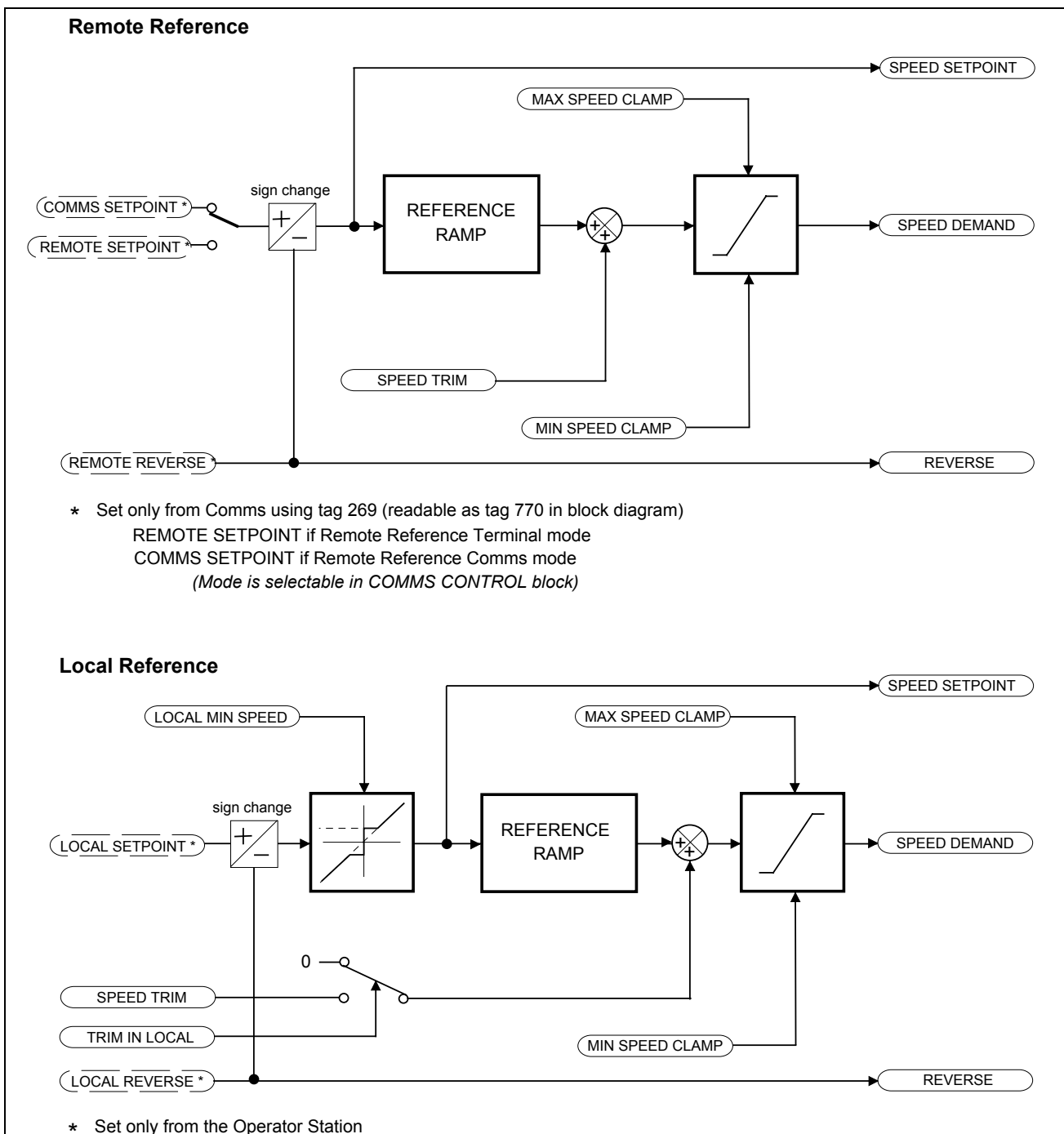

1-30 Programming Your Application

REFERENCE JOG

This block holds all the parameters that concern the Jog functionality on the drive.

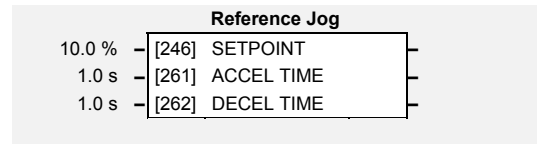

Parameter Descriptions

SETPOINT *PAR\ P8* *Range: -100.0 to 100.0 %*
The setpoint is the target reference that the drive will ramp to.

ACCEL TIME *SET\SETP ST01* *Range: 0.0 to 3000.0 s*
The time that the drive will take to ramp the jog setpoint from 0.00% to 100.00%.

DECEL TIME *SET\SETP ST02* *Range: 0.0 to 3000.0 s*
The time that the drive will take to ramp the jog setpoint from 100.00% to 0.00%.

Functional Description

The REFERENCE JOG function block is used to configure the action of the drive when used in jog mode.

Start/Stop Controlled Remotely

When the JOG input is TRUE, the SPEED DEMAND (REFERENCE function block) ramps up to the jog SETPOINT at a ramp rate set by jog ACCEL TIME. The drive will continue to run at the jog SETPOINT while the JOG input remains TRUE.

Start/Stop Controlled Locally (6901 keypad)

When the JOG key is pressed and held, the SPEED DEMAND (REFERENCE function block) ramps up to the jog SETPOINT at a ramp rate set by jog ACCEL TIME. Release the jog key to "stop" the drive.

Interaction between RUN and JOG

Only one of these signals can be in effect at any one time; the other signal is ignored. The drive must be "stopped" to change from running to jogging, or vice versa.

REFERENCE STOP

This function block holds all the parameters concerning the stopping method of the drive.

Reference Stop		
RAMPED	[279]	RUN STOP MODE
10.0 s	[263]	STOP TIME
0.1 %	[266]	STOP ZERO SPEED
0.5 s	[284]	STOP DELAY
RAMPED	[304]	FAST STOP MODE
30.0 s	[275]	FAST STOP LIMIT
0.1 s	[264]	FAST STOP TIME
1200 Hz/s	[126]	FINAL STOP RATE

Parameter Descriptions

RUN STOP MODE *PAR\ P9* *Range: Enumerated - see below*
 Selects stopping mode that the controller will use once the run command has been removed. The choices are:

Enumerated Value : Stopping Mode

- 0 : RAMPED
- 1 : COAST
- 2 : DC INJECTION

When RAMPED is selected the drive will decelerate using the reference ramp deceleration time, provided it is non zero. When COAST is selected the motor will free-wheel. When DC INJECTION is selected the motor is stopped by applying dc current.

STOP TIME *Range: 0.0 to 600.0 s*
 Rate at which the demand is ramped to zero after the ramp has been quenched.

STOP ZERO SPEED *Range: 0.0 to 100.0 %*
 Threshold for zero speed detection used by stop sequences.

STOP DELAY *Range: 0.0 to 30.0 s*
 Sets the time at which the drive holds zero speed before quenching after a normal stop or a jog stop. This may be particularly useful if a mechanical brake requires time to operate at zero speed, or for jogging a machine to position.

FAST STOP MODE *Range: Enumerated - see below*
 Selects stopping mode used during a fast stop, two options ramped or coast.

Enumerated Value : Stopping Mode

- 0 : RAMPED
- 1 : COAST

FAST STOP LIMIT *Range: 0.0 to 3000.0 s*
 Maximum time that the drive will try to Fast Stop, before quenching.

FAST STOP TIME *Range: 0.0 to 600.0 s*
 Rate at which the SPEED DEMAND is ramped to zero (see REFERENCE function block)

FINAL STOP RATE *Range: 12 to 4800 Hz/s*
 Rate at which any internally generated setpoint trims are removed. For example, the trim due to the slip compensation block.

SEQUENCING LOGIC

This function block contains all the parameters relating to the sequencing (start and stop) of the drive.

Before the drive will respond to the RUN FWD, RUN REV or JOG parameters (cause the drive to run or jog), the parameters DRIVE ENABLE, NOT FAST STOP and NOT COAST STOP need to be set to TRUE. In addition, the drive needs to be healthy (HEALTHY is TRUE). The drive will only respond to RUN FWD, RUN REV and JOG if the drive is in the Remote Sequencing mode.

If RUN FWD and RUN REV are TRUE, both are ignored and the drive will stop.

Sequencing Logic			
	TRIPPED	[289]	FALSE
	RUNNING	[285]	FALSE
	JOGGING	[302]	FALSE
	STOPPING	[303]	FALSE
	OUTPUT CONTACTOR	[286]	FALSE
	SWITCH ON ENABLE	[288]	TRUE
	SWITCHED ON	[306]	FALSE
	READY	[287]	FALSE
	SYSTEM RESET	[305]	FALSE
	SEQUENCER STATE	[301]	START ENABLED
	REMOTE REV OUT	[296]	FALSE
	HEALTHY	[274]	TRUE
FALSE	[291] RUN FORWARD		
FALSE	[292] RUN REVERSE		
FALSE	[293] NOT STOP		
FALSE	[280] JOG		
TRUE	[1235] CONTACTOR CLOSED		
TRUE	[276] DRIVE ENABLE		
TRUE	[277] NOT FAST STOP		
TRUE	[278] NOT COAST STOP		
FALSE	[294] REMOTE REVERSE		
FALSE	[282] REM TRIP RESET		
TRUE	[290] TRIP RST BY RUN		
TRUE	[283] POWER UP START		

Parameter Descriptions

RUN FWD

Range: FALSE / TRUE

Setting this parameter to TRUE causes the drive to run in the forward direction.

RUN REV

Range: FALSE / TRUE

Setting this parameter to TRUE causes the drive to run in the reverse direction.

NOT STOP

Range: FALSE / TRUE

Setting this parameter TRUE will latch the RUN FWD or RUN REV commands. Once latched, they can be reset to FALSE and the drive will continue to run. Setting NOT STOP to FALSE causes the run commands to be unlatched.

JOG

Range: FALSE / TRUE

Setting this parameter TRUE causes the drive to run at the speed set by JOG SETPOINT (refer to the REFERENCE JOG function block). Once jogging, setting JOG to FALSE causes the drive to ramp to zero.

CONTACTOR CLOSED

Range: FALSE / TRUE

Feedback used to indicate that the external contactor has been closed. It must be TRUE for the sequencer to proceed from the SWITCHED ON state to the READY STATE, refer to SEQUENCER STATE.

DRIVE ENABLE

Range: FALSE / TRUE

This provides a means of electronically inhibiting drive operation. Whilst running, setting this parameter to FALSE disables the drive operation and causes the motor to coast.

NOT FAST STOP

Range: FALSE / TRUE

Whilst running or jogging, setting this parameter to FALSE causes the drive to ramp to zero. The rate is set by FAST STOP RATE in the STOP function block. The action of setting NOT FAST STOP to TRUE is latched. The drive cannot be restarted until fast stop is completed. This signal is effective even when the drive is in Local mode.

NOT COAST STOP

Range: FALSE / TRUE

Setting this parameter to FALSE disables the drive operation and causes the motor to coast. The action of setting this parameter to TRUE is latched. The drive can not be restarted until the coast stop is completed. This signal is effective even when the drive is in Local mode.

1-34 Programming Your Application

REMOTE REVERSE	<i>Range: FALSE / TRUE</i>
For remote setpoints, setting this to TRUE inverts the demanded direction of motor rotation.	
REM TRIP RESET	<i>Range: FALSE / TRUE</i>
On a transition to TRUE, this input clears latched trips.	
TRIP RST BY RUN	<i>Range: FALSE / TRUE</i>
This allows the rising edge of run command to clear latched trips.	
POWER UP START	<i>Range: FALSE / TRUE</i>
If TRUE, this allows the drive to go directly to run mode if in remote and a run command is present. If FALSE, a low to high transition of the run command is required.	
TRIPPED	<i>Range: FALSE / TRUE</i>
Indicates that there is a latched trip present.	
RUNNING	<i>Range: FALSE / TRUE</i>
Indicates that that the drive is in the enabled state.	
JOGGING	<i>Range: FALSE / TRUE</i>
Indicates that the drive is in the JOG mode.	
STOPPING	<i>Range: FALSE / TRUE</i>
Indicates that the drive is stopping.	
OUTPUT CONTACTOR	<i>Range: FALSE / TRUE</i>
Output to be used to drive an external contactor in the motor output. This contactor is normally closed unless a Trip condition has occurred or the drive goes into the re-configuration mode.	
SWITCH ON ENABLE	<i>Range: FALSE / TRUE</i>
Sometimes referred to as READY TO SWITCH ON, this parameter indicates that the drive will accept a run command.	
SWITCHED ON	<i>Range: FALSE / TRUE</i>
Run accepted. Waiting for CONTACTOR CLOSED and deflux to be completed	
READY	<i>Range: FALSE / TRUE</i>
Indicates that the drive's power stack is operable and the drive will run if enabled.	
SYSTEM RESET	<i>Range: FALSE / TRUE</i>
TRUE for a single block diagram execution cycle after drive enters either RUN or JOG mode.	
SEQUENCER STATE	<i>Range: Enumerated - see below</i>
This parameter indicates the current sequencing state:	
<i>Enumerated Value : State</i>	
0 : START DISABLED	
1 : START ENABLED	
2 : SWITCHED ON	
3 : READY	
4 : ENABLED	
5 : F-STOP ACTIVE	
6 : TRIP ACTIVE	
7 : TRIPPED	
REMOTE REV OUT	<i>Range: FALSE / TRUE</i>
This parameter indicates the current state of remote direction and RUN REV. Note - this is the demanded direction, not the actual direction.	
HEALTHY	<i>Range: FALSE / TRUE</i>
Set FALSE when the drive trips, and set TRUE when the run command is removed. This output is False while the pre-charge relay is open on power-up.	

SKIP FREQUENCIES

This function block may be used to prevent the drive operating at frequencies that cause mechanical resonance in the load.

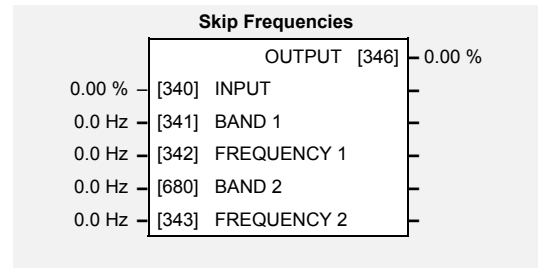

Parameter Descriptions

INPUT

The value of the block input in %.

Range: -300.00 to 300.00 %

BAND 1

The width of each skip band in Hz.

SET\SETP ST12

Range: 0.0 to 60.0 Hz

FREQUENCY 1

This parameter contains the centre frequency of each skip band in Hz.

SET\SETP ST11

Range: 0.0 to 240.0 Hz

BAND 2

The width of each skip band in Hz.

SET\SETP ST14

Range: 0.0 to 60.0 Hz

FREQUENCY 2

This parameter contains the centre frequency of each skip band in Hz.

SET\SETP ST13

Range: 0.0 to 240.0 Hz

OUTPUT

Diagnostic on the output of the function block in %

Range: —.xx %

Functional Description

Four programmable skip frequencies are available to avoid resonances within the mechanical system. Enter the value of frequency that causes the resonance using the “FREQUENCY” parameter and then programme the width of the skip band using its “BAND” parameter. The drive will then avoid sustained operation within the forbidden band as shown in the diagram. The skip frequencies are symmetrical and thus work in forward and reverse.

Note: Setting the FREQUENCY to 0 disables the corresponding band.
Setting the BAND to 0 causes the value of BAND 1 to be used for this band.

1-36 Programming Your Application

The behaviour of this function block is illustrated below.

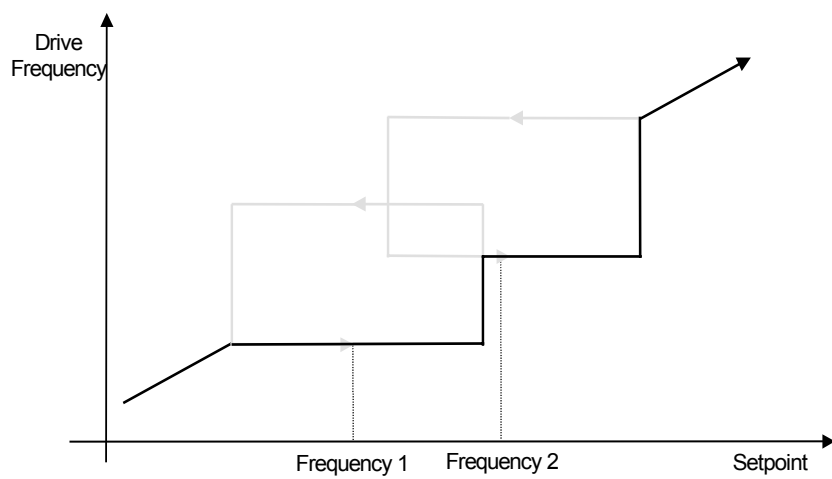
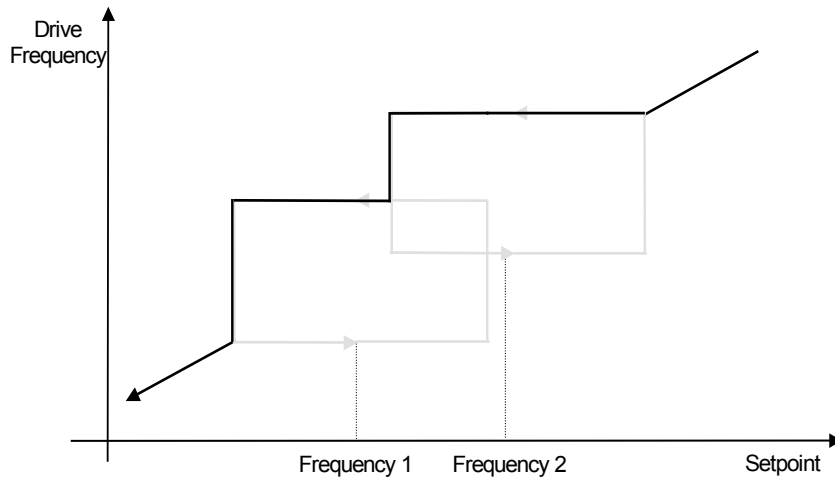
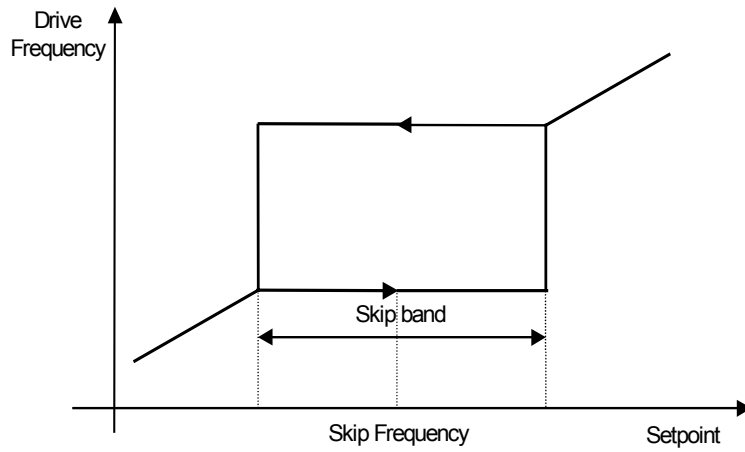

TRIPS STATUS

The drive supports advanced and flexible trip logic to support monitoring of the drive itself, the motor and the load. This function block provides a view in to the current trip condition(s) and allows some trips to be disabled.

Refer to the "Trips and Fault Finding" chapter in the Installation Product Manual for trip descriptions.

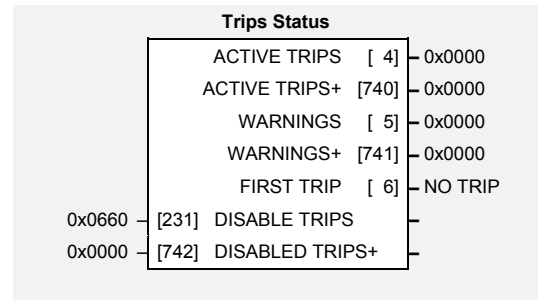

Parameter Descriptions

DISABLE TRIPS and DISABLE TRIPS+

Range: 0000 to FFFF

Indicates which trips have been disabled. Not all trips may be disabled, the DISABLED TRIPS mask is ignored for trips that cannot be disabled. See below for which trips may be disabled and how this parameter is formed.

ACTIVE TRIPS and ACTIVE TRIPS+

Range: 0000 to FFFF

Indicates all active trips, including user-disabled trips that are reporting a trip condition. The parameter returns a coded representation of the trip status. See below for a description of how this parameter is formed.

WARNINGS and WARNINGS+

Range: 0000 to FFFF

Indicates which conditions are likely to cause a trip, including potential conditions that may affect user-disabled trips. These parameters are a coded representation of the warning status. See below for a description of how this parameter is formed.

FIRST TRIP

Range: Enumerated – see table below

From when a trip occurs until that trip is reset, this parameter indicates the trip source. When several trips have occurred, this parameter indicates the first one that was detected.

Functional Description

The tables below show the possible parameter values for the FIRST TRIP, TRIPS HISTORY and the AUTO RESTART function blocks. Each trip has a unique, four-digit hexadecimal number as shown in the tables below.

ACTIVE TRIPS, WARNINGS, DISABLE TRIPS and TRIGGERS 1 (AUTO RESTART function block)				
ID	Trip Name (MMI 6901)	Trip Name (MMI 6511 & 6521)	Mask	Frames 1-3 User Disable
0	NO TRIP		0x0000	N/A
1	OVERVOLTAGE	DCHI	0x0001	
2	UNDERVOLTAGE	DCLO	0x0002	
3	OVERCURRENT	OC	0x0004	
4	HEATSINK	HOT	0x0008	
5	EXTERNAL TRIP	ET	0x0010	✓
6	INVERSE TIME	51 t	0x0020	✓
7	CURRENT LOOP	5 LOOP	0x0040	✓
8	MOTOR STALLED	55 t LL	0x0080	✓
9	ANIN FAULT	5 t 3	0x0100	✓
12	DISPLAY/KEYPAD	5 dl 5 P	0x0800	✓
13	LOST COMMS	SCI	0x1000	✓
14	CONTACTOR FBK	CNTC	0x2000	✓

ACTIVE TRIPS+, WARNINGS+, DISABLE TRIPS+ and TRIGGERS 1+ (AUTO RESTART function block)				
ID	Trip Name (MMI 6901)	Trip Name (MMI 6511 & 6521)	Mask +	Frames 1-3 User Disable
17	MOTOR OVERTEMP	<input type="text" value="50t"/>	0x0001	✓
18	CURRENT LIMIT	I HI	0x0002	
19	<i>Trip 19 (Reserved)</i>	TR19	0x0004	
21	LOW SPEED OVER I	LSPD	0x0010	
22	10V FAULT	T 4	0x0020	✓
23	<i>Trip 23 (Reserved)</i>	TR23	0x0040	
25	DC LINK RIPPLE	DCRP	0x0100	
27	OVERSPEED	OSPD	0x0400	
28	ANOUT FAULT	T 5	0x0800	✓
29	DIGIO 1 (T9) FAULT	T 9	0x1000	✓
30	DIGIO 2 (T10) FAULT	T 10	0x2000	✓
31	UNKNOWN	TRIP	0x4000	
32	OTHER	TR32	0x8000	
33	ZERO I CALIB	ICAL	0x8000	

Enter FFFF to select/accept all, for example, entering FFFF for TRIGGERS 1 would make the drive auto-restart for trips with IDs from 1 to 16 inclusive.

Keypads (MMIs):

Trips shown as displays, i.e. , can be disabled using the keypads in the TRIPS menu. Other trips, as indicated, can be disabled over the Comms.



6901



6511



6521

Hexadecimal Representation of Trips

When more than one trip is to be represented at the same time then the trip codes are simply added together to form the value displayed. Within each digit, values between 10 and 15 are displayed as letters A to F

For example referring to the tables above, if the ACTIVE TRIPS parameter is **01C2**, then this represents:

- a “1” in digit 3
- an “8” and a “4” in digit 2
(8+4 = 12, displayed as C)
- an “2” in digit 1

Decimal number	Display
10	A
11	B
12	C
13	D
14	E
15	F

This in turn represents the active trips ANIN FAULT, MOTOR STALLED, CURRENT LOOP and UNDERVOLTAGE.

In the same way, the ACTIVE TRIPS + parameter displaying **0C31** would represent ANOUT FAULT, OVERSPEED, 10V FAULT, LOW SPEED OVER I and MOTOR OVERTEMP.

Note: *The hexadecimal value is used over comms, however, pressing the **M** key whilst displaying the hexadecimal trip value will show the list of all trips and their current values.*

PARAMETER SPECIFICATION

The headings for the Tag No. table are described below.

Tag	A numeric identification of the parameter used for communications access
Pref	A numeric identification of the parameter used internally by the drive
MMI Name	The parameter name as it appears on the MMI (keypad).
Parameter Name	The parameter name.
Function Block	The function block in which the parameter resides.
Type	REAL Floating point value INT Integer value BOOL A Boolean (bit) representing FALSE or TRUE ENUM An enumerated value representing a selection WORD 16 Bit hexadecimal number
Range	This varies with parameter type: REAL, INT The upper and lower limits of the parameter BOOL 0 = FALSE, 1 = TRUE ENUM A list of possible selections for that parameter WORD 0000 to FFFF (hexadecimal)
ID	Serial Communications Mnemonic: Refer to Chapter 3: "Serial Communications"

In the MMI Parameters table the following Notes apply:

- F** Parameter only visible on MMI in detailed menus mode.
- M** Parameter is a Motor parameter, not reset on changing Application.
- (0) Modbus decimal point is xxxx.
- (1) Modbus decimal point is xxx.x
- (2) Modbus decimal point is xx.xx
- (3) Modbus decimal point is x.xxx

Specification Table: Tag Number Order

Specification Table: Tag Number Order							
TAG	Pref	Parameter Name	MMI Name	Function Block Name	Range	Type	ID
4	50.03	ACTIVE TRIPS		TRIPS STATUS	Output	WORD	04
5	50.05	WARNINGS		TRIPS STATUS	Output	WORD	05
6	50.07	FIRST TRIP		TRIPS STATUS	As FIRST TRIP	ENUM	06
8	21.01	PASSWORD	PAR 99	MMI ACCESS	0x0000 to 0xFFFF	WORD	08
13	10.03	TYPE	SET\IN IP13	ANALOG INPUT 1	0 : 0..10 V 1 : 0..5 V	ENUM	0d
14	10.01	SCALE	SET\IN IP11	ANALOG INPUT 1	-300.00 to 300.00	REAL	0e
15	10.02	OFFSET	SET\IN IP12	ANALOG INPUT 1	-300.00 to 300.00	REAL	0f
16	10.05	VALUE	SET\IN IPA1	ANALOG INPUT 1	Output (2)	REAL	0g
22	11.03	TYPE	SET\IN IP23	ANALOG INPUT 2	0 : 0..10 V 1 : 0..5 V 2 : 0..20 mA 3 : 4..20 mA	ENUM	0m
23	11.01	SCALE	SET\IN IP21	ANALOG INPUT 2	-300.00 to 300.00	REAL	0n
24	11.02	OFFSET	SET\IN IP22	ANALOG INPUT 2	-300.00 to 300.00	REAL	0o

2-2 Parameter Specification

Specification Table: Tag Number Order							
TAG	Pref	Parameter Name	MMI Name	Function Block Name	Range	Type	ID
25	11.06	VALUE	SET\IN IPA2	ANALOG INPUT 2	Output (2)	REAL	0p
26	11.04	BREAK VALUE		ANALOG INPUT 2	-100.0 to 100.0 (2)	REAL	0q
30	13.1.1	INVERT	SET\IN IP01	DIGITAL INPUT 1	0 to 1	BOOL	0u
31	13.1.2	VALUE	SET\IN IPD1	DIGITAL INPUT 1	Output	BOOL	0v
33	13.2.1	INVERT	SET\IN IP02	DIGITAL INPUT 2	0 to 1	BOOL	0x
34	13.2.2	VALUE	SET\IN IPD2	DIGITAL INPUT 2	Output	BOOL	0y
36	13.3.1	INVERT	SET\IN IP03	DIGITAL INPUT 3	0 to 1	BOOL	10
37	13.3.2	VALUE	SET\IN IPD3	DIGITAL INPUT 3	Output	BOOL	11
39	13.4.1	INVERT	SET\IN IP04	DIGITAL INPUT 4	0 to 1	BOOL	13
40	13.4.2	VALUE	SET\IN IPD4	DIGITAL INPUT 4	Output	BOOL	14
45	12.01	VALUE	SET\OUT OP05	ANALOG OUTPUT	-300.0 to 300.0 (2)	REAL	19
46	12.02	SCALE	SET\OUT OP02	ANALOG OUTPUT	-300.00 to 300.00	REAL	1a
47	12.03	OFFSET	SET\OUT OP03	ANALOG OUTPUT	-300.00 to 300.00	REAL	1b
48	12.04	ABSOLUTE	SET\OUT OP04	ANALOG OUTPUT	0 to 1	BOOL	1c
50	27.01	NORMAL DUTY	PAR 12	FEEDBACKS	0 to 1	BOOL	1e
54	14.2.2	INVERT	SET\OUT OP22	DIGITAL OUTPUT 2	0 to 1	BOOL	1i
55	14.2.1	VALUE	SET\OUT OP23	DIGITAL OUTPUT 2	0 to 1	BOOL	1j
57	23.03	MAX SPEED	PAR 2	REFERENCE	7.5 to 240.0	REAL	1l
64	35.03	MOTOR CURRENT	PAR 6	MOTOR DATA	0.01 to 999.99 (1)	REAL	1s
65	35.04	MAG CURRENT		MOTOR DATA	0.01 to 999.99 (1)	REAL	1t
66	27.03	MOTOR CURRENT %		FEEDBACKS	Output	REAL	1u
67	27.04	MOTOR CURRENT A	DIAG 4	FEEDBACKS	Output	REAL	1v
75	27.02	DC LINK VOLTS	DIAG 3	FEEDBACKS	Output	REAL	23
83	35.05	NAMEPLATE RPM		MOTOR DATA	0.0 to 30000.0 (0)	REAL	2b
84	35.06	MOTOR POLES		MOTOR DATA	0 : 2 POLE 1 : 4 POLE 2 : 6 POLE 3 : 8 POLE 4 : 10 POLE 5 : 12 POLE	ENUM	2c
98	25.01	RANDOM PATTERN		PATTERN GEN	0 to 1	BOOL	2q
100	25.02	DEFLUX DELAY		PATTERN GEN	0.1 to 10.0	REAL	2s
102	18.01	GROUP ID (GID)		COMMS PORTS	0 to 7	INT	2u
103	18.02	COMMS ADDRESS	SET\SERL SE03	COMMS PORTS	0 to 255	INT	2v
104	33.01	V/F SHAPE	PAR 11	FLUXING	0 : LINEAR LAW 1 : FAN LAW	ENUM	2w
107	33.02	FIXED BOOST	PAR 13	FLUXING	0.00 to 25.00	REAL	2z
108	33.03	AUTO BOOST		FLUXING	0.00 to 25.00	REAL	30
126	43.08	FINAL STOP RATE		REFERENCE STOP	12. to 4800.	REAL	3i
127	22.1.1	ENABLED KEYS	SET\SETP ST52	DISPLAY/KEYPAD	0x0000 to 0xFFFF	WORD	3j
230	22.1.2	DISP VERSION		DISPLAY/KEYPAD	Output	WORD	6e
231	50.01	DISABLE TRIPS	SET\TRIP LOOP	TRIPS STATUS	0x0000 to 0xFFFF	WORD	6f
243	23.06	TRIM IN LOCAL		REFERENCE	0 to 1	BOOL	6r
244	42.01	RAMP TYPE	SET\SETP ST03	REFERENCE RAMP	0 : LINEAR 1 : S	ENUM	6s
245	23.01	REMOTE SETPOINT		REFERENCE	-110.0 to 110.0 (2)	REAL	6t
246	20.01	SETPOINT	PAR 8	REFERENCE JOG	-100.0 to 100.0 (2)	REAL	6u
247	23.13	LOCAL SETPOINT		REFERENCE	-100.0 to 100.0 (2)	REAL	6v
248	23.02	SPEED TRIM		REFERENCE	-110.0 to 110.0 (2)	REAL	6w
249	23.07	REMOTE REVERSE		REFERENCE	0 to 1	BOOL	6x
250	23.15	LOCAL REVERSE		REFERENCE	Output	BOOL	6y
251	23.16	LOCAL MIN SPEED	SET\SETP ST51	REFERENCE	0.0 to 100.0	REAL	6z
252	23.04	MAX SPEED CLAMP		REFERENCE	0.0 to 110.0 (2)	REAL	70
253	23.05	MIN SPEED CLAMP		REFERENCE	-110.0 to 0.0 (2)	REAL	71
254	23.10	SPEED SETPOINT	DIAG 2	REFERENCE	Output (2)	REAL	72
255	23.09	SPEED DEMAND		REFERENCE	Output (2)	REAL	73
256	23.12	REVERSE		REFERENCE	Output	BOOL	74
258	42.02	ACCEL TIME	PAR 4	REFERENCE RAMP	0.0 to 3000.0	REAL	76

Specification Table: Tag Number Order							
TAG	Pref	Parameter Name	MMI Name	Function Block Name	Range	Type	ID
259	42.03	DECEL TIME	PAR 5	REFERENCE RAMP	0.0 to 3000.0	REAL	77
260	42.06	HOLD		REFERENCE RAMP	0 to 1	BOOL	78
261	20.02	ACCEL TIME	SET\SETP ST01	REFERENCE JOG	0.0 to 3000.0	REAL	79
262	20.03	DECEL TIME	SET\SETP ST02	REFERENCE JOG	0.0 to 3000.0	REAL	7a
263	43.02	STOP TIME		REFERENCE STOP	0.0 to 600.0	REAL	7b
264	43.07	FAST STOP TIME		REFERENCE STOP	0.0 to 600.0	REAL	7c
266	43.03	STOP ZERO SPEED		REFERENCE STOP	0.0 to 100.0 (2)	REAL	7e
270	19.07	COMMS REF		COMMS CONTROL	Output	BOOL	7i
272	19.08	COMMS STATUS		COMMS CONTROL	Output	WORD	7k
273	19.09	COMMS COMMAND		COMMS CONTROL	Output	WORD	7l
274	24.24	HEALTHY		SEQUENCING LOGIC	Output	BOOL	7m
275	43.06	FAST STOP LIMIT		REFERENCE STOP	0.0 to 3000.0	REAL	7n
276	24.06	DRIVE ENABLE		SEQUENCING LOGIC	0 to 1	BOOL	7o
277	24.07	NOT FAST STOP		SEQUENCING LOGIC	0 to 1	BOOL	7p
278	24.08	NOT COAST STOP		SEQUENCING LOGIC	0 to 1	BOOL	7q
279	43.01	RUN STOP MODE	PAR 9	REFERENCE STOP	0 : RAMPED 1 : COAST 2 : DC INJECTION	ENUM	7r
280	24.04	JOG		SEQUENCING LOGIC	0 to 1	BOOL	7s
282	24.10	REM TRIP RESET		SEQUENCING LOGIC	0 to 1	BOOL	7u
283	24.12	POWER UP START		SEQUENCING LOGIC	0 to 1	BOOL	7v
284	43.04	STOP DELAY		REFERENCE STOP	0.0 to 30.0 (3)	REAL	7w
285	24.14	RUNNING		SEQUENCING LOGIC	Output	BOOL	7x
286	24.17	OUTPUT CONTACTOR		SEQUENCING LOGIC	Output	BOOL	7y
287	24.20	READY		SEQUENCING LOGIC	Output	BOOL	7z
288	24.18	SWITCH ON ENABLE		SEQUENCING LOGIC	Output	BOOL	80
289	24.13	TRIPPED		SEQUENCING LOGIC	Output	BOOL	81
290	24.11	TRIP RST BY RUN		SEQUENCING LOGIC	0 to 1	BOOL	82
291	24.01	RUN FORWARD		SEQUENCING LOGIC	0 to 1	BOOL	83
292	24.02	RUN REVERSE		SEQUENCING LOGIC	0 to 1	BOOL	84
293	24.03	NOT STOP		SEQUENCING LOGIC	0 to 1	BOOL	85
294	24.09	REMOTE REVERSE		SEQUENCING LOGIC	0 to 1	BOOL	86
295	19.06	COMMS SEQ		COMMS CONTROL	Output	BOOL	87
296	24.23	REMOTE REV OUT		SEQUENCING LOGIC	Output	BOOL	88
300	19.01	REMOTE COMMS SEL	SET\SERL SE01	COMMS CONTROL	0 to 1	BOOL	8c
301	24.22	SEQUENCER STATE		SEQUENCING LOGIC	0 : START DISABLED 1 : START ENABLED 2 : SWITCHED ON 3 : READY 4 : ENABLED 5 : F-STOP ACTIVE 6 : TRIP ACTIVE 7 : TRIPPED	ENUM	8d
302	24.15	JOGGING		SEQUENCING LOGIC	Output	BOOL	8e
303	24.16	STOPPING		SEQUENCING LOGIC	Output	BOOL	8f
304	43.05	FAST STOP MODE		REFERENCE STOP	0 : RAMPED 1 : COAST	ENUM	8g
305	24.21	SYSTEM RESET		SEQUENCING LOGIC	Output	BOOL	8h
306	24.19	SWITCHED ON		SEQUENCING LOGIC	Output	BOOL	8i
307	19.02	REMOTE SEQ MODES		COMMS CONTROL	0 : TERMINALS/COMMS 1 : TERMINALS ONLY 2 : COMMS ONLY	ENUM	8j
308	19.03	REMOTE REF MODES		COMMS CONTROL	0 : TERMINALS/COMMS 1 : TERMINALS ONLY 2 : COMMS ONLY	ENUM	8k
309	19.04	COMMS TIMEOUT	SET\SERL SE02	COMMS CONTROL	0.0 to 600.0	REAL	8l
325	44.08	OUTPUT		RAISE/LOWER	Output	REAL	91
326	44.03	RAMP TIME	PAR 401	RAISE/LOWER	0.0 to 600.0	REAL	92
327	44.01	RAISE INPUT		RAISE/LOWER	0 to 1	BOOL	93
328	44.02	LOWER INPUT		RAISE/LOWER	0 to 1	BOOL	94

2-4 Parameter Specification

Specification Table: Tag Number Order							
TAG	Pref	Parameter Name	MMI Name	Function Block Name	Range	Type	ID
329	44.05	MIN VALUE	PAR 403	RAISE/LOWER	-100.00 to 100.00	REAL	95
330	44.04	MAX VALUE	PAR 402	RAISE/LOWER	-100.00 to 100.00	REAL	96
331	44.06	RESET VALUE	PAR 404	RAISE/LOWER	-100.00 to 100.00	REAL	97
332	44.07	RESET		RAISE/LOWER	0 to 1	BOOL	98
335	45.04	OUTPUT		MINIMUM SPEED	Output (2)	REAL	9b
336	45.01	INPUT		MINIMUM SPEED	-300.0 to 300.0 (2)	REAL	9c
337	45.02	MINIMUM	PAR 3	MINIMUM SPEED	-100.0 to 100.0 (2)	REAL	9d
338	45.03	MODE		MINIMUM SPEED	0 : PROP. W/MIN 1 : LINEAR	ENUM	9e
340	55.01	INPUT		SKIP FREQUENCIES	-300.00 to 300.00	REAL	9g
341	55.02	BAND 1	SET\SETP ST12	SKIP FREQUENCIES	0.0 to 60.0	REAL	9h
342	55.03	FREQUENCY 1	SET\SETP ST11	SKIP FREQUENCIES	0.0 to 240.0	REAL	9i
343	55.05	FREQUENCY 2	SET\SETP ST13	SKIP FREQUENCIES	0.0 to 240.0	REAL	9j
346	55.06	OUTPUT		SKIP FREQUENCIES	Output	REAL	9m
347	17.02	INPUT 0	PAR 301	PRESET	-32768.00 to 32767.00	REAL	9n
348	17.03	INPUT 1	PAR 302	PRESET	-32768.00 to 32767.00	REAL	9o
349	17.04	INPUT 2	PAR 303	PRESET	-32768.00 to 32767.00	REAL	9p
350	17.05	INPUT 3	PAR 304	PRESET	-32768.00 to 32767.00	REAL	9q
351	17.06	INPUT 4	PAR 305	PRESET	-32768.00 to 32767.00	REAL	9r
352	17.07	INPUT 5	PAR 306	PRESET	-32768.00 to 32767.00	REAL	9s
353	17.08	INPUT 6	PAR 307	PRESET	-32768.00 to 32767.00	REAL	9t
354	17.09	INPUT 7	PAR 308	PRESET	-32768.00 to 32767.00	REAL	9u
355	17.01	SELECT INPUT		PRESET	0 : INPUT 0 1 : INPUT 1 2 : INPUT 2 3 : INPUT 3 4 : INPUT 4 5 : INPUT 5 6 : INPUT 6 7 : INPUT 7	ENUM	9v
356	17.10	OUTPUT 1		PRESET	Output	REAL	9w
372	17.11	OUTPUT 2		PRESET	Output	REAL	ac
591	25.03	DRIVE FREQUENCY	DIAG 1	PATTERN GEN	Output (2)	REAL	gf
608	40.05	PENDING		AUTO RESTART	Output	BOOL	gw
609	40.03	TRIGGERS 1	SET\SETP ST23	AUTO RESTART	0x0000 to 0xFFFF	WORD	gx
612	40.01	ATTEMPTS	SET\SETP ST21	AUTO RESTART	0 to 10	INT	h0
613	40.02	ATTEMPT DELAY 1	SET\SETP ST22	AUTO RESTART	0.0 to 600.0	REAL	h1
614	40.07	ATTEMPTS LEFT		AUTO RESTART	Output	INT	h2
615	40.08	TIME LEFT		AUTO RESTART	Output	REAL	h3
616	40.06	RESTARTING		AUTO RESTART	Output	BOOL	h4
617	46.02	FEEDBACK		PID	-300.00 to 300.00	REAL	h5
618	46.04	FEEDBACK GAIN	PAR 505	PID	-10.00 to 10.00	REAL	h6
619	46.14	ERROR	PAR 508	PID	Output	REAL	h7
680	55.04	BAND 2	SET\SETP ST14	SKIP FREQUENCIES	0.0 to 60.0	REAL	iw
691	42.05	SRAMP CONTINUOUS	SET\SETP ST05	REFERENCE RAMP	0 to 1	BOOL	j7
694	42.04	SRAMP JERK 1	SET\SETP ST04	REFERENCE RAMP	0.01 to 100.00	REAL	ja
698	42.07	RAMPING		REFERENCE RAMP	Output	BOOL	je
736	14.3.2	INVERT	SET\OUT OP32	DIGITAL OUTPUT 3	0 to 1	BOOL	kg
737	14.3.1	VALUE	SET\OUT OP33	DIGITAL OUTPUT 3	0 to 1	BOOL	kh
740	50.04	ACTIVE TRIPS+		TRIPS STATUS	Output	WORD	kk
741	50.06	WARNINGS+		TRIPS STATUS	Output	WORD	kl
742	50.02	DISABLE TRIPS+	SET\TRIP OT	TRIPS STATUS	0x0000 to 0xFFFF	WORD	km
744	40.04	TRIGGERS 1 +	SET\SETP ST24	AUTO RESTART	0x0000 to 0xFFFF	WORD	ko
770	23.14	COMMS SETPOINT		REFERENCE	Output (2)	REAL	le
878	21.02	DETAILED MENUS	SET\SETP ST99	MMI ACCESS	0 to 1	BOOL	oe
1058	33.07	601 FLUXING		FLUXING	0 to 1	BOOL	te

Parameter Specification 2-5

Specification Table: Tag Number Order							
TAG	Pref	Parameter Name	MMI Name	Function Block Name	Range	Type	ID
1059	18.07	P3 PORT PROTOCOL	SET\SERL SE08	COMMS PORTS	0 : AUTOMATIC 1 : KEYPAD 2 : EIBISYNC ASCII 3 : MODBUS 4 : FIELDBUS	ENUM	tf
1060	18.06	OP PORT PROTOCOL	SET\SERL SE07	COMMS PORTS	0 : AUTOMATIC 1 : KEYPAD 2 : EIBISYNC ASCII 3 : MODBUS 4 : FIELDBUS	ENUM	tg
1061	18.04	PARITY	SET\SERL SE05	COMMS PORTS	0 : NONE 1 : ODD 2 : EVEN	ENUM	th
1062	18.03	BAUD RATE	SET\SERL SE04	COMMS PORTS	0 : 1200 1 : 2400 2 : 4800 3 : 7200 4 : 9600 5 : 14400 6 : 19200 7 : 38400 8 : 57600	ENUM	ti
1064	7.05	APP LOCK	SET\SETP ST98	APP CONFIG	0 to 1	BOOL	tk
1091	7.01	APPLICATION	PAR 1	APP CONFIG	0 : NULL 1 : STANDARD 2 : LOCAL/REM 3 : PRESETS 4 : RAISE/LOWER 5 : PID 6 : APP 6 7 : APP 7 8 : APP 8 9 : CUSTOM	ENUM	ub
1092	7.02	ANOUT SOURCE	SET\OUT OP01	APP CONFIG	0 : NONE 1 : DEMAND 2 : CURRENT 3 : PID ERROR 4 : R/L OUTPUT	ENUM	uc
1093	7.03	RELAY SOURCE	SET\OUT OP31	APP CONFIG	0 : NONE 1 : HEALTH 2 : TRIPPED 3 : RUNNING 4 : AT ZERO 5 : AT SPEED	ENUM	ud
1094	7.04	DIGIO 2 SOURCE	SET\OUT OP21	APP CONFIG	0 : NONE 1 : HEALTH 2 : TRIPPED 3 : RUNNING 4 : AT ZERO 5 : AT SPEED	ENUM	ue
1098	46.11	INTEGRAL DEFEAT		PID	0 to 1	BOOL	ui
1110	22.2.2	DISP VERSION		DISPLAY/KEYPAD	Output	WORD	uu
1159	35.01	BASE FREQUENCY	PAR 7	MOTOR DATA	25.0 to 240.0	REAL	w7
1160	35.02	MOTOR VOLTAGE		MOTOR DATA	0.0 to 575.0	REAL	w8
1235	24.05	CONTACTOR CLOSED		SEQUENCING LOGIC	0 to 1	BOOL	yb
1247	46.01	SETPOINT		PID	-300.00 to 300.00	REAL	yn
1248	46.03	FEED FWD		PID	-300.00 to 300.00	REAL	yo
1249	46.05	FEED FWD GAIN		PID	-10.00 to 10.00	REAL	yp
1250	46.06	P GAIN	PAR 501	PID	0.00 to 100.00	REAL	yq
1251	46.07	I GAIN	PAR 502	PID	0.00 to 100.00	REAL	yr
1252	46.08	D GAIN	PAR 503	PID	0.00 to 100.00	REAL	ys
1253	46.09	LIMIT	PAR 506	PID	0.00 to 300.00	REAL	yt
1254	46.10	ENABLE PID		PID	0 to 1	BOOL	yu
1255	46.12	D FILTER TC	PAR 504	PID	0.05 to 5.00	REAL	yv
1256	46.13	OUTPUT	PAR 509	PID	Output	REAL	yw
1257	46.15	LIMITING		PID	Output	BOOL	yx
1258	46.16	OUTPUT SCALING	PAR 507	PID	-3.0000 to 3.0000	REAL	yy
1260	18.05	REPLY DELAY ms	SET\SERL SE06	COMMS PORTS	0 to 200	INT	z0

2-6 Parameter Specification

Specification Table: Pref Order

Specification Table: Pref Order							
Pref	TAG	Parameter Name	MMI Name	Function Block Name	Range	Type	ID
7.01	1091	APPLICATION	PAR 1	APP CONFIG	0 : NULL 1 : STANDARD 2 : LOCAL/REM 3 : PRESETS 4 : RAISE/LOWER 5 : PID 6 : APP 6 7 : APP 7 8 : APP 8 9 : CUSTOM	ENUM	ub
7.02	1092	ANOUT SOURCE	SET\OUT OP01	APP CONFIG	0 : NONE 1 : DEMAND 2 : CURRENT 3 : PID ERROR 4 : R/L OUTPUT	ENUM	uc
7.03	1093	RELAY SOURCE	SET\OUT OP31	APP CONFIG	0 : NONE 1 : HEALTH 2 : TRIPPED 3 : RUNNING 4 : AT ZERO 5 : AT SPEED	ENUM	ud
7.04	1094	DIGIO 2 SOURCE	SET\OUT OP21	APP CONFIG	0 : NONE 1 : HEALTH 2 : TRIPPED 3 : RUNNING 4 : AT ZERO 5 : AT SPEED	ENUM	ue
7.05	1064	APP LOCK	SET\SETP ST98	APP CONFIG	0 to 1	BOOL	tk
10.01	14	SCALE	SET\IN IP11	ANALOG INPUT 1	-300.00 to 300.00	REAL	0e
10.02	15	OFFSET	SET\IN IP12	ANALOG INPUT 1	-300.00 to 300.00	REAL	0f
10.03	13	TYPE	SET\IN IP13	ANALOG INPUT 1	0 : 0..10 V 1 : 0...5 V	ENUM	0d
10.05	16	VALUE	SET\IN IPA1	ANALOG INPUT 1	Output (2)	REAL	0g
11.01	23	SCALE	SET\IN IP21	ANALOG INPUT 2	-300.00 to 300.00	REAL	0n
11.02	24	OFFSET	SET\IN IP22	ANALOG INPUT 2	-300.00 to 300.00	REAL	0o
11.03	22	TYPE	SET\IN IP23	ANALOG INPUT 2	0 : 0..10 V 1 : 0...5 V 2 : 0..20 mA 3 : 4..20 mA	ENUM	0m
11.04	26	BREAK VALUE		ANALOG INPUT 2	-100.0 to 100.0 (2)	REAL	0q
11.06	25	VALUE	SET\IN IPA2	ANALOG INPUT 2	Output (2)	REAL	0p
12.01	45	VALUE	SET\OUT OP05	ANALOG OUTPUT	-300.0 to 300.0 (2)	REAL	19
12.02	46	SCALE	SET\OUT OP02	ANALOG OUTPUT	-300.00 to 300.00	REAL	1a
12.03	47	OFFSET	SET\OUT OP03	ANALOG OUTPUT	-300.00 to 300.00	REAL	1b
12.04	48	ABSOLUTE	SET\OUT OP04	ANALOG OUTPUT	0 to 1	BOOL	1c
13.1.1	30	INVERT	SET\IN IP01	DIGITAL INPUT 1	0 to 1	BOOL	0u
13.1.2	31	VALUE	SET\IN IPD1	DIGITAL INPUT 1	Output	BOOL	0v
13.2.1	33	INVERT	SET\IN IP02	DIGITAL INPUT 2	0 to 1	BOOL	0x
13.2.2	34	VALUE	SET\IN IPD2	DIGITAL INPUT 2	Output	BOOL	0y
13.3.1	36	INVERT	SET\IN IP03	DIGITAL INPUT 3	0 to 1	BOOL	10
13.3.2	37	VALUE	SET\IN IPD3	DIGITAL INPUT 3	Output	BOOL	11
13.4.1	39	INVERT	SET\IN IP04	DIGITAL INPUT 4	0 to 1	BOOL	13
13.4.2	40	VALUE	SET\IN IPD4	DIGITAL INPUT 4	Output	BOOL	14
14.2.1	55	VALUE	SET\OUT OP23	DIGITAL OUTPUT 2	0 to 1	BOOL	1j
14.2.2	54	INVERT	SET\OUT OP22	DIGITAL OUTPUT 2	0 to 1	BOOL	1i
14.3.1	737	VALUE	SET\OUT OP33	DIGITAL OUTPUT 3	0 to 1	BOOL	kh
14.3.2	736	INVERT	SET\OUT OP32	DIGITAL OUTPUT 3	0 to 1	BOOL	kg

Specification Table: Pref Order							
Pref	TAG	Parameter Name	MMI Name	Function Block Name	Range	Type	ID
17.01	355	SELECT INPUT		PRESET	0 : INPUT 0 1 : INPUT 1 2 : INPUT 2 3 : INPUT 3 4 : INPUT 4 5 : INPUT 5 6 : INPUT 6 7 : INPUT 7	ENUM	9v
17.02	347	INPUT 0	PAR 301	PRESET	-32768.00 to 32767.00	REAL	9n
17.03	348	INPUT 1	PAR 302	PRESET	-32768.00 to 32767.00	REAL	9o
17.04	349	INPUT 2	PAR 303	PRESET	-32768.00 to 32767.00	REAL	9p
17.05	350	INPUT 3	PAR 304	PRESET	-32768.00 to 32767.00	REAL	9q
17.06	351	INPUT 4	PAR 305	PRESET	-32768.00 to 32767.00	REAL	9r
17.07	352	INPUT 5	PAR 306	PRESET	-32768.00 to 32767.00	REAL	9s
17.08	353	INPUT 6	PAR 307	PRESET	-32768.00 to 32767.00	REAL	9t
17.09	354	INPUT 7	PAR 308	PRESET	-32768.00 to 32767.00	REAL	9u
17.10	356	OUTPUT 1		PRESET	Output	REAL	9w
17.11	372	OUTPUT 2		PRESET	Output	REAL	ac
18.01	102	GROUP ID (GID)		COMMS PORTS	0 to 7	INT	2u
18.02	103	COMMS ADDRESS	SET\SERL SE03	COMMS PORTS	0 to 255	INT	2v
18.03	1062	BAUD RATE	SET\SERL SE04	COMMS PORTS	0 : 1200 1 : 2400 2 : 4800 3 : 7200 4 : 9600 5 : 14400 6 : 19200 7 : 38400 8 : 57600	ENUM	ti
18.04	1061	PARITY	SET\SERL SE05	COMMS PORTS	0 : NONE 1 : ODD 2 : EVEN	ENUM	th
18.05	1260	REPLY DELAY ms	SET\SERL SE06	COMMS PORTS	0 to 200	INT	z0
18.06	1060	OP PORT PROTOCOL	SET\SERL SE07	COMMS PORTS	0 : AUTOMATIC 1 : KEYPAD 2 : EIBISYNC ASCII 3 : MODBUS 4 : FIELDBUS	ENUM	tg
18.07	1059	P3 PORT PROTOCOL	SET\SERL SE08	COMMS PORTS	0 : AUTOMATIC 1 : KEYPAD 2 : EIBISYNC ASCII 3 : MODBUS 4 : FIELDBUS	ENUM	tf
19.01	300	REMOTE COMMS SEL	SET\SERL SE01	COMMS CONTROL	0 to 1	BOOL	8c
19.02	307	REMOTE SEQ MODES		COMMS CONTROL	0 : TERMINALS/COMMS 1 : TERMINALS ONLY 2 : COMMS ONLY	ENUM	8j
19.03	308	REMOTE REF MODES		COMMS CONTROL	0 : TERMINALS/COMMS 1 : TERMINALS ONLY 2 : COMMS ONLY	ENUM	8k
19.04	309	COMMS TIMEOUT	SET\SERL SE02	COMMS CONTROL	0.0 to 600.0	REAL	8l
19.06	295	COMMS SEQ		COMMS CONTROL	Output	BOOL	87
19.07	270	COMMS REF		COMMS CONTROL	Output	BOOL	7i
19.08	272	COMMS STATUS		COMMS CONTROL	Output	WORD	7k
19.09	273	COMMS COMMAND		COMMS CONTROL	Output	WORD	7l
20.01	246	SETPOINT	PAR 8	REFERENCE JOG	-100.0 to 100.0 (2)	REAL	6u
20.02	261	ACCEL TIME	SET\SETP ST01	REFERENCE JOG	0.0 to 3000.0	REAL	79
20.03	262	DECEL TIME	SET\SETP ST02	REFERENCE JOG	0.0 to 3000.0	REAL	7a
21.01	8	PASSWORD	PAR 99	MMI ACCESS	0x0000 to 0xFFFF	WORD	08
21.02	878	DETAILED MENUS	SET\SETP ST99	MMI ACCESS	0 to 1	BOOL	oe
22.1.1	127	ENABLED KEYS	SET\SETP ST52	DISPLAY/KEYPAD	0x0000 to 0xFFFF	WORD	3j
22.1.2	230	DISP VERSION		DISPLAY/KEYPAD	Output	WORD	6e
22.2.2	1110	DISP VERSION		DISPLAY/KEYPAD	Output	WORD	uu
23.01	245	REMOTE SETPOINT		REFERENCE	-110.0 to 110.0 (2)	REAL	6t
23.02	248	SPEED TRIM		REFERENCE	-110.0 to 110.0 (2)	REAL	6w

2-8 Parameter Specification

Specification Table: Pref Order							
Pref	TAG	Parameter Name	MMI Name	Function Block Name	Range	Type	ID
23.03	57	MAX SPEED	PAR 2	REFERENCE	7.5 to 240.0	REAL	1l
23.04	252	MAX SPEED CLAMP		REFERENCE	0.0 to 110.0 (2)	REAL	70
23.05	253	MIN SPEED CLAMP		REFERENCE	-110.0 to 0.0 (2)	REAL	71
23.06	243	TRIM IN LOCAL		REFERENCE	0 to 1	BOOL	6r
23.07	249	REMOTE REVERSE		REFERENCE	0 to 1	BOOL	6x
23.09	255	SPEED DEMAND		REFERENCE	Output (2)	REAL	73
23.10	254	SPEED SETPOINT	DIAG 2	REFERENCE	Output (2)	REAL	72
23.12	256	REVERSE		REFERENCE	Output	BOOL	74
23.13	247	LOCAL SETPOINT		REFERENCE	-100.0 to 100.0 (2)	REAL	6v
23.14	770	COMMS SETPOINT		REFERENCE	Output (2)	REAL	1e
23.15	250	LOCAL REVERSE		REFERENCE	Output	BOOL	6y
23.16	251	LOCAL MIN SPEED	SET\SETP ST51	REFERENCE	0.0 to 100.0	REAL	6z
24.01	291	RUN FORWARD		SEQUENCING LOGIC	0 to 1	BOOL	83
24.02	292	RUN REVERSE		SEQUENCING LOGIC	0 to 1	BOOL	84
24.03	293	NOT STOP		SEQUENCING LOGIC	0 to 1	BOOL	85
24.04	280	JOG		SEQUENCING LOGIC	0 to 1	BOOL	7s
24.05	1235	CONTACTOR CLOSED		SEQUENCING LOGIC	0 to 1	BOOL	yb
24.06	276	DRIVE ENABLE		SEQUENCING LOGIC	0 to 1	BOOL	7o
24.07	277	NOT FAST STOP		SEQUENCING LOGIC	0 to 1	BOOL	7p
24.08	278	NOT COAST STOP		SEQUENCING LOGIC	0 to 1	BOOL	7q
24.09	294	REMOTE REVERSE		SEQUENCING LOGIC	0 to 1	BOOL	86
24.10	282	REM TRIP RESET		SEQUENCING LOGIC	0 to 1	BOOL	7u
24.11	290	TRIP RST BY RUN		SEQUENCING LOGIC	0 to 1	BOOL	82
24.12	283	POWER UP START		SEQUENCING LOGIC	0 to 1	BOOL	7v
24.13	289	TRIPPED		SEQUENCING LOGIC	Output	BOOL	81
24.14	285	RUNNING		SEQUENCING LOGIC	Output	BOOL	7x
24.15	302	JOGGING		SEQUENCING LOGIC	Output	BOOL	8e
24.16	303	STOPPING		SEQUENCING LOGIC	Output	BOOL	8f
24.17	286	OUTPUT CONTACTOR		SEQUENCING LOGIC	Output	BOOL	7y
24.18	288	SWITCH ON ENABLE		SEQUENCING LOGIC	Output	BOOL	80
24.19	306	SWITCHED ON		SEQUENCING LOGIC	Output	BOOL	8i
24.20	287	READY		SEQUENCING LOGIC	Output	BOOL	7z
24.21	305	SYSTEM RESET		SEQUENCING LOGIC	Output	BOOL	8h
24.22	301	SEQUENCER STATE		SEQUENCING LOGIC	0 : START DISABLED 1 : START ENABLED 2 : SWITCHED ON 3 : READY 4 : ENABLED 5 : F-STOP ACTIVE 6 : TRIP ACTIVE 7 : TRIPPED	ENUM	8d
24.23	296	REMOTE REV OUT		SEQUENCING LOGIC	Output	BOOL	88
24.24	274	HEALTHY		SEQUENCING LOGIC	Output	BOOL	7m
25.01	98	RANDOM PATTERN		PATTERN GEN	0 to 1	BOOL	2q
25.02	100	DEFLUX DELAY		PATTERN GEN	0.1 to 10.0	REAL	2s
25.03	591	DRIVE FREQUENCY	DIAG 1	PATTERN GEN	Output (2)	REAL	gf
27.01	50	NORMAL DUTY	PAR 12	FEEDBACKS	0 to 1	BOOL	1e
27.02	75	DC LINK VOLTS	DIAG 3	FEEDBACKS	Output	REAL	23
27.03	66	MOTOR CURRENT %		FEEDBACKS	Output	REAL	1u
27.04	67	MOTOR CURRENT A	DIAG 4	FEEDBACKS	Output	REAL	1v
33.01	104	V/F SHAPE	PAR 11	FLUXING	0 : LINEAR LAW 1 : FAN LAW	ENUM	2w
33.02	107	FIXED BOOST	PAR 13	FLUXING	0.00 to 25.00	REAL	2z
33.03	108	AUTO BOOST		FLUXING	0.00 to 25.00	REAL	30
33.07	1058	601 FLUXING		FLUXING	0 to 1	BOOL	te
35.01	1159	BASE FREQUENCY	PAR 7	MOTOR DATA	25.0 to 240.0	REAL	w7
35.02	1160	MOTOR VOLTAGE		MOTOR DATA	0.0 to 575.0	REAL	w8
35.03	64	MOTOR CURRENT	PAR 6	MOTOR DATA	0.01 to 999.99 (1)	REAL	1s

Specification Table: Pref Order							
Pref	TAG	Parameter Name	MMI Name	Function Block Name	Range	Type	ID
35.04	65	MAG CURRENT		MOTOR DATA	0.01 to 999.99 (1)	REAL	1t
35.05	83	NAMEPLATE RPM		MOTOR DATA	0.0 to 30000.0 (0)	REAL	2b
35.06	84	MOTOR POLES		MOTOR DATA	0 : 2 POLE 1 : 4 POLE 2 : 6 POLE 3 : 8 POLE 4 : 10 POLE 5 : 12 POLE	ENUM	2c
40.01	612	ATTEMPTS	SET\SETP ST21	AUTO RESTART	0 to 10	INT	h0
40.02	613	ATTEMPT DELAY 1	SET\SETP ST22	AUTO RESTART	0.0 to 600.0	REAL	h1
40.03	609	TRIGGERS 1	SET\SETP ST23	AUTO RESTART	0x0000 to 0xFFFF	WORD	gx
40.04	744	TRIGGERS 1+	SET\SETP ST24	AUTO RESTART	0x0000 to 0xFFFF	WORD	ko
40.05	608	PENDING		AUTO RESTART	Output	BOOL	gw
40.06	616	RESTARTING		AUTO RESTART	Output	BOOL	h4
40.07	614	ATTEMPTS LEFT		AUTO RESTART	Output	INT	h2
40.08	615	TIME LEFT		AUTO RESTART	Output	REAL	h3
42.01	244	RAMP TYPE	SET\SETP ST03	REFERENCE RAMP	0 : LINEAR 1 : S	ENUM	6s
42.02	258	ACCEL TIME	PAR 4	REFERENCE RAMP	0.0 to 3000.0	REAL	76
42.03	259	DECEL TIME	PAR 5	REFERENCE RAMP	0.0 to 3000.0	REAL	77
42.04	694	SRAMP JERK 1	SET\SETP ST04	REFERENCE RAMP	0.01 to 100.00	REAL	ja
42.05	691	SRAMP CONTINUOUS	SET\SETP ST05	REFERENCE RAMP	0 to 1	BOOL	j7
42.06	260	HOLD		REFERENCE RAMP	0 to 1	BOOL	78
42.07	698	RAMPING		REFERENCE RAMP	Output	BOOL	je
43.01	279	RUN STOP MODE	PAR 9	REFERENCE STOP	0 : RAMPED 1 : COAST 2 : DC INJECTION	ENUM	7r
43.02	263	STOP TIME		REFERENCE STOP	0.0 to 600.0	REAL	7b
43.03	266	STOP ZERO SPEED		REFERENCE STOP	0.0 to 100.0 (2)	REAL	7e
43.04	284	STOP DELAY		REFERENCE STOP	0.0 to 30.0 (3)	REAL	7w
43.05	304	FAST STOP MODE		REFERENCE STOP	0 : RAMPED 1 : COAST	ENUM	8g
43.06	275	FAST STOP LIMIT		REFERENCE STOP	0.0 to 3000.0	REAL	7n
43.07	264	FAST STOP TIME		REFERENCE STOP	0.0 to 600.0	REAL	7c
43.08	126	FINAL STOP RATE		REFERENCE STOP	12. to 4800.	REAL	3i
44.01	327	RAISE INPUT		RAISE/LOWER	0 to 1	BOOL	93
44.02	328	LOWER INPUT		RAISE/LOWER	0 to 1	BOOL	94
44.03	326	RAMP TIME	PAR 401	RAISE/LOWER	0.0 to 600.0	REAL	92
44.04	330	MAX VALUE	PAR 402	RAISE/LOWER	-100.00 to 100.00	REAL	96
44.05	329	MIN VALUE	PAR 403	RAISE/LOWER	-100.00 to 100.00	REAL	95
44.06	331	RESET VALUE	PAR 404	RAISE/LOWER	-100.00 to 100.00	REAL	97
44.07	332	RESET		RAISE/LOWER	0 to 1	BOOL	98
44.08	325	OUTPUT		RAISE/LOWER	Output	REAL	91
45.01	336	INPUT		MINIMUM SPEED	-300.0 to 300.0 (2)	REAL	9c
45.02	337	MINIMUM	PAR 3	MINIMUM SPEED	-100.0 to 100.0 (2)	REAL	9d
45.03	338	MODE		MINIMUM SPEED	0 : PROP. W/MIN 1 : LINEAR	ENUM	9e
45.04	335	OUTPUT		MINIMUM SPEED	Output (2)	REAL	9b
46.01	1247	SETPOINT		PID	-300.00 to 300.00	REAL	yn
46.02	617	FEEDBACK		PID	-300.00 to 300.00	REAL	h5
46.03	1248	FEED FWD		PID	-300.00 to 300.00	REAL	yo
46.04	618	FEEDBACK GAIN	PAR 505	PID	-10.00 to 10.00	REAL	h6
46.05	1249	FEED FWD GAIN		PID	-10.00 to 10.00	REAL	yp
46.06	1250	P GAIN	PAR 501	PID	0.00 to 100.00	REAL	yq
46.07	1251	I GAIN	PAR 502	PID	0.00 to 100.00	REAL	yr
46.08	1252	D GAIN	PAR 503	PID	0.00 to 100.00	REAL	ys
46.09	1253	LIMIT	PAR 506	PID	0.00 to 300.00	REAL	yt
46.10	1254	ENABLE PID		PID	0 to 1	BOOL	yu
46.11	1098	INTEGRAL DEFEAT		PID	0 to 1	BOOL	ui

2-10 Parameter Specification

Specification Table: Pref Order

Pref	TAG	Parameter Name	MMI Name	Function Block Name	Range	Type	ID
46.12	1255	D FILTER TC	PAR 504	PID	0.05 to 5.00	REAL	yv
46.13	1256	OUTPUT	PAR 509	PID	Output	REAL	yw
46.14	619	ERROR	PAR 508	PID	Output	REAL	h7
46.15	1257	LIMITING		PID	Output	BOOL	yx
46.16	1258	OUTPUT SCALING	PAR 507	PID	-3.0000 to 3.0000	REAL	yy
50.01	231	DISABLE TRIPS	SET\TRIP LOOP	TRIPS STATUS	0x0000 to 0xFFFF	WORD	6f
50.02	742	DISABLE TRIPS+	SET\TRIP OT	TRIPS STATUS	0x0000 to 0xFFFF	WORD	km
50.03	4	ACTIVE TRIPS		TRIPS STATUS	Output	WORD	04
50.04	740	ACTIVE TRIPS+		TRIPS STATUS	Output	WORD	kk
50.05	5	WARNINGS		TRIPS STATUS	Output	WORD	05
50.06	741	WARNINGS+		TRIPS STATUS	Output	WORD	kl
50.07	6	FIRST TRIP		TRIPS STATUS	As FIRST TRIP	ENUM	06
55.01	340	INPUT		SKIP FREQUENCIES	-300.00 to 300.00	REAL	9g
55.02	341	BAND 1	SET\SETP ST12	SKIP FREQUENCIES	0.0 to 60.0	REAL	9h
55.03	342	FREQUENCY 1	SET\SETP ST11	SKIP FREQUENCIES	0.0 to 240.0	REAL	9i
55.04	680	BAND 2	SET\SETP ST14	SKIP FREQUENCIES	0.0 to 60.0	REAL	iw
55.05	343	FREQUENCY 2	SET\SETP ST13	SKIP FREQUENCIES	0.0 to 240.0	REAL	9j
55.06	346	OUTPUT		SKIP FREQUENCIES	Output	REAL	9m

Specification Table: MMI Name Order

Specification Table: MMI Name Order						
MMI Name	ASCII MMI Name	Function Block Name	Parameter Name	Notes	TAG	ID
PAR Menu (Parameter)						
PAR 1	APPLICATION	APP CONFIG	APPLICATION		1091	ub
PAR 2	MAX SPEED	REFERENCE	MAX SPEED	M	57	1l
PAR 3	MIN SPEED	MINIMUM SPEED	MINIMUM		337	9d
PAR 4	ACCEL TIME	REFERENCE RAMP	ACCEL TIME		258	76
PAR 5	DECEL TIME	REFERENCE RAMP	DECEL TIME		259	77
PAR 6	MOTOR CURRENT	MOTOR DATA	MOTOR CURRENT	M	64	1s
PAR 7	BASE FREQUENCY	MOTOR DATA	BASE FREQUENCY	M	1159	w7
PAR 8	JOG SETPOINT	REFERENCE JOG	SETPOINT		246	6u
PAR 9	RUN STOP MODE	REFERENCE STOP	RUN STOP MODE		279	7r
PAR 11	V/F SHAPE	FLUXING	V/F SHAPE		104	2w
PAR 12	NORMAL DUTY	FEEDBACKS	NORMAL DUTY		50	1e
PAR 13	FIXED BOOST	FLUXING	FIXED BOOST	M	107	2z
PAR 99	PASSWORD	MMI ACCESS	PASSWORD		8	08
PAR 301	PRESET 0	PRESET	INPUT 0		347	9n
PAR 302	PRESET 1	PRESET	INPUT 1		348	9o
PAR 303	PRESET 2	PRESET	INPUT 2		349	9p
PAR 304	PRESET 3	PRESET	INPUT 3		350	9q
PAR 305	PRESET 4	PRESET	INPUT 4		351	9r
PAR 306	PRESET 5	PRESET	INPUT 5		352	9s
PAR 307	PRESET 6	PRESET	INPUT 6		353	9t
PAR 308	PRESET 7	PRESET	INPUT 7		354	9u
PAR 401	RL RAMP RATE	RAISE/LOWER	RAMP TIME		326	92
PAR 402	RL MAX VALUE	RAISE/LOWER	MAX VALUE		330	96
PAR 403	RL MIN VALUE	RAISE/LOWER	MIN VALUE		329	95
PAR 404	RL RESET VALUE	RAISE/LOWER	RESET VALUE		331	97
PAR 501	PI P GAIN	PID	P GAIN		1250	yq
PAR 502	PI I GAIN	PID	I GAIN		1251	yr
PAR 503	PID D GAIN	PID	D GAIN	F	1252	ys
PAR 504	PID D FILTER TC	PID	D FILTER TC	F	1255	yv
PAR 505	PID FBK GAIN	PID	FEEDBACK GAIN	F	618	h6
PAR 506	PID LIMIT	PID	LIMIT	F	1253	yt
PAR 507	PID SCALE	PID	OUTPUT SCALING	F	1258	YY
PAR 508	PID ERROR	PID	ERROR	F	619	h7
PAR 509	PID OUTPUT	PID	OUTPUT	F	1256	yw
IN Menu (Input)						
SET\IN IP01	DIGIN 1 INVERT	DIGITAL INPUT 1 (Terminal 7)	INVERT		30	0u
SET\IN IP02	DIGIN 2 INVERT	DIGITAL INPUT 2 (Terminal 8)	INVERT		33	0x
SET\IN IP03	DIGIN 3 INVERT	DIGITAL INPUT 3 (Terminal 9)	INVERT		36	10
SET\IN IP04	DIGIN 4 INVERT	DIGITAL INPUT 4 (Terminal 10)	INVERT		39	13
SET\IN IP11	ANIN 1 SCALE	ANALOG INPUT 1	SCALE		14	0e
SET\IN IP12	ANIN 1 OFFSET	ANALOG INPUT 1	OFFSET		15	0f
SET\IN IP13	ANIN 1 TYPE	ANALOG INPUT 1	TYPE		13	0d
SET\IN IP21	ANIN 2 SCALE	ANALOG INPUT 2	SCALE		23	0n
SET\IN IP22	ANIN 2 OFFSET	ANALOG INPUT 2	OFFSET		24	0o
SET\IN IP23	ANIN 2 TYPE	ANALOG INPUT 2	TYPE		22	0m
SET\IN IPD1	DIGIN 1 VALUE	DIGITAL INPUT 1 (Terminal 7)	VALUE	F	31	0v
SET\IN IPD2	DIGIN 2 VALUE	DIGITAL INPUT 2 (Terminal 8)	VALUE	F	34	0y
SET\IN IPD3	DIGIN 3 VALUE	DIGITAL INPUT 3 (Terminal 9)	VALUE	F	37	11
SET\IN IPD4	DIGIN 4 VALUE	DIGITAL INPUT 4 (Terminal 10)	VALUE	F	40	14
SET\IN IPA1	ANIN 1 VALUE	ANALOG INPUT 1	VALUE	F	16	0g
SET\IN IPA2	ANIN 2 VALUE	ANALOG INPUT 2	VALUE	F	25	0p

2-12 Parameter Specification

Specification Table: MMI Name Order						
MMI Name	ASCII MMI Name	Function Block Name	Parameter Name	Notes	TAG	ID
OUT Menu (Output)						
SET\OUT OP01	ANOUT SOURCE	APP CONFIG	ANOUT SOURCE		1092	uc
SET\OUT OP02	ANOUT SCALE	ANALOG OUTPUT	SCALE		46	1a
SET\OUT OP03	ANOUT OFFSET	ANALOG OUTPUT	OFFSET		47	1b
SET\OUT OP04	ANOUT ABS	ANALOG OUTPUT	ABSOLUTE		48	1c
SET\OUT OP05	ANOUT VALUE	ANALOG OUTPUT	VALUE		45	19
SET\OUT OP21	DIGOUT 2 SOURCE	APP CONFIG	DIGIO 2 SOURCE		1094	ue
SET\OUT OP22	DIGOUT 2 INVERT	DIGITAL OUTPUT 2 (Terminal 10)	INVERT		54	1i
SET\OUT OP23	DIGOUT 2 VALUE	DIGITAL OUTPUT 2 (Terminal 10)	VALUE		55	1j
SET\OUT OP31	RELAY SOURCE	APP CONFIG	RELAY SOURCE		1093	ud
SET\OUT OP32	RELAY INVERT	DIGITAL OUTPUT 3 (Relay)	INVERT		736	kg
SET\OUT OP33	RELAY VALUE	DIGITAL OUTPUT 3 (Relay)	VALUE		737	kh
TRIP Menu (Trips)						
SET\TRIP LOOP	4 TO 20ma LOOP	TRIPS STATUS	DISABLE TRIPS		231	6f
SET\TRIP T3	ANIN 2 OVERLOAD	TRIPS STATUS	DISABLE TRIPS		231	6f
SET\TRIP STLL	MOTOR STALLED	TRIPS STATUS	DISABLE TRIPS		231	6f
SET\TRIP OT	MOTOR OVERTEMP	TRIPS STATUS	DISABLE TRIPS+		742	km
SET\TRIP IT	INVERSE TIME	TRIPS STATUS	DISABLE TRIPS		231	6f
SET\TRIP DISP	DISPLAY / KEYPAD	TRIPS STATUS	DISABLE TRIPS		231	6f
SERL Menu (Serial Communications)						
SET\SERL SE01	REMOTE COMMS SEL	COMMS CONTROL	REMOTE COMMS SEL		300	8c
SET\SERL SE02	COMMS TIMEOUT	COMMS CONTROL	COMMS TIMEOUT		309	8l
SET\SERL SE03	COMMS ADDRESS	COMMS PORTS	COMMS ADDRESS		103	2v
SET\SERL SE04	COMMS BAUD RATE	COMMS PORTS	BAUD RATE		1062	ti
SET\SERL SE05	COMMS PARITY	COMMS PORTS	PARITY		1061	th
SET\SERL SE06	REPLY DELAY ms	COMMS PORTS	REPLY DELAY ms		1260	z0
SET\SERL SE07	PROTOCOL, (OP)	COMMS PORTS	OP PORT PROTOCOL		1060	tg
SET\SERL SE08	PROTOCOL, (P3)	COMMS PORTS	P3 PORT PROTOCOL		1059	tf
SETP Menu (Setup)						
SET\SETP ST01	JOG ACCEL TIME	REFERENCE JOG	ACCEL TIME		261	79
SET\SETP ST02	JOG DECEL TIME	REFERENCE JOG	DECEL TIME		262	7a
SET\SETP ST03	RAMP TYPE	REFERENCE RAMP	RAMP TYPE		244	6s
SET\SETP ST04	S RAMP JERK	REFERENCE RAMP	SRAMP JERK 1		694	ja
SET\SETP ST05	S RAMP CONT	REFERENCE RAMP	SRAMP CONTINUOUS		691	j7
SET\SETP ST11	SKIP FREQ 1	SKIP FREQUENCIES	FREQUENCY 1		342	9i
SET\SETP ST12	SKIP FREQ 1 BAND	SKIP FREQUENCIES	BAND 1		341	9h
SET\SETP ST13	SKIP FREQ 2	SKIP FREQUENCIES	FREQUENCY 2		343	9j
SET\SETP ST14	SKIP FREQ 2 BAND	SKIP FREQUENCIES	BAND 2		680	iw
SET\SETP ST21	AR ATTEMPTS	AUTO RESTART	ATTEMPTS		612	h0
SET\SETP ST22	AR DELAY	AUTO RESTART	ATTEMPT DELAY 1		613	h1
SET\SETP ST23	AR TRIGGERS	AUTO RESTART	TRIGGERS 1		609	gx
SET\SETP ST24	AR TRIGGERS+	AUTO RESTART	TRIGGERS 1+		744	ko
SET\SETP ST51	LOCAL MIN SPEED	REFERENCE	LOCAL MIN SPEED		251	6z
SET\SETP ST52	DISABLED KEYS	DISPLAY/KEYPAD	DISABLED KEYS		127	3j
SET\SETP ST98	APPLICATION LOCK	APP CONFIG	APP LOCK		1064	tk
SET\SETP ST99	DETAILED MENUS	MMI ACCESS	DETAILED MENUS		878	oe

Product-Related Default Values

All examples given in this book are based on a UK, 230V, 50Hz, 0.25kW drive.

* Frequency Dependent Defaults

These parameter values (marked with “**” in function block descriptions and Application diagrams) are dependent upon the drive’s “default frequency”.

Changing the “default frequency” parameter from 50Hz to 60Hz, and vice versa, causes the values of the parameters in the table below to be changed.

To change the “default frequency”, power-down the drive. Power-up the drive holding down the STOP and DOWN keys on the keypad. Release the keys to display the ° 0.01 parameter.

Caution

You are now in a menu containing some sensitive and important parameters.

Press the UP key to display the ° 0.02 parameter. Press the M key. The values for this parameter are: 0 = 50Hz default, 1 = 60Hz default. Select the setting using the UP/DOWN keys and then press the E key. Power-down the drive and power-up again holding down the UP and DOWN keys. This resets **ALL** parameters to their correct default values, including Motor Parameters.

Display	Parameter	Function Block	Tag	50Hz Operation	60Hz Operation
<input type="text" value="P 7"/>	BASE FREQUENCY	MOTOR DATA	1159	50Hz	60Hz
<input type="text" value="P 2"/>	MAX SPEED	SETPOINT SCALE	57	1500 RPM	1800 RPM

** Power Dependent Defaults

These parameters (marked with “**” in function block descriptions and Application diagrams) are set to a value depending on the drive’s overall “power-build” indicated by the Product Code.

230V Build Power Dependent Defaults								
Parameter	Function Block	Tag	Frame 1				Frame 2	
			0.25kW	0.37kW	0.55kW	0.75kW	1.1kW	1.5kW
MOTOR CURRENT	MOTOR DATA	64	1.50 A	2.20 A	3.00 A	4.00 A	5.50 A	7.00 A
MAG CURRENT	MOTOR DATA	65	0.80 A	0.80 A	1.04 A	1.36 A	2.50 A	3.41 A
NAMEPLATE RPM	MOTOR DATA	83	1380.0 RPM	1380.0 RPM	1400.0 RPM	1400.0 RPM	1420.0 RPM	1420.0 RPM
MOTOR VOLTAGE	MOTOR DATA	1160	230.0 V	230.0 V	230.0 V	230.0 V	230.0 V	230.0 V
FREQUENCY	INJ BRAKING	577	9.0 Hz	9.0 Hz	9.0 Hz	9.0 Hz	9.0 Hz	9.0 Hz
DEFLUX TIME	INJ BRAKING	710	0.1 s	0.1 s	0.1 s	0.1 s	0.1 s	0.1 s
BASE VOLTS	INJ BRAKING	739	100.00 %	100.00 %	100.00 %	100.00 %	100.00 %	100.00 %
DC LEVEL	INJ BRAKING	581	10.0 %	10.0 %	10.0 %	10.0 %	3.0 %	3.0 %
DC PULSE	INJ BRAKING	579	1.0 s	1.0 s	1.0 s	1.0 s	2.0 s	2.0 s
FINAL DC PULSE	INJ BRAKING	580	2.0 s	2.0 s	2.0 s	2.0 s	1.0 s	1.0 s
FIXED BOOST	FLUXING	107	5.00 %	5.00 %	5.00 %	5.00 %	5.00 %	5.00 %
ACCEL TIME	REFERENCE RAMP	258	10.0 s	10.0 s	10.0 s	10.0 s	10.0 s	10.0 s
DECEL TIME	REFERENCE RAMP	259	10.0 s	10.0 s	10.0 s	10.0 s	10.0 s	10.0 s
DEFLUX DELAY	PATTERN GEN	100	0.5 s	0.5 s	0.5 s	0.5 s	1.0 s	1.0 s

2-14 Parameter Specification

230V Build Power Dependent Defaults			Frame 3		
Parameter	Function Block	Tag	2.2kW	3.0kW	4.0kW
MOTOR CURRENT	MOTOR DATA	64	9.60 A	12.30 A	16.40 A
MAG CURRENT	MOTOR DATA	65	3.36 A	3.39 A	4.38 A
NAMEPLATE RPM	MOTOR DATA	83	1420.0 RPM	1445.0 RPM	1450.0 RPM
MOTOR VOLTAGE	MOTOR DATA	1160	230.0 V	230.0 V	230.0 V
FREQUENCY	INJ BRAKING	577	9.0 Hz	9.0 Hz	9.0 Hz
DEFLUX TIME	INJ BRAKING	710	0.5 s	0.5 s	0.5 s
BASE VOLTS	INJ BRAKING	739	100.00 %	100.00 %	100.00 %
DC LEVEL	INJ BRAKING	581	3.0 %	3.0 %	3.0 %
DC PULSE	INJ BRAKING	579	2.0 s	2.0 s	2.0 s
FINAL DC PULSE	INJ BRAKING	580	1.0 s	1.0 s	1.0 s
FIXED BOOST	FLUXING	107	3.00 %	3.00 %	3.00 %
ACCEL TIME	REFERENCE RAMP	258	10.0 s	10.0 s	10.0 s
DECEL TIME	REFERENCE RAMP	259	10.0 s	10.0 s	10.0 s
DEFLUX DELAY	PATTERN GEN	100	2.0 s	2.0 s	2.0 s

400V Build Power Dependent Defaults			Frame 2					
Parameter	Function Block	Tag	0.37kW	0.55kW	0.75kW	1.1kW	1.5kW	2.2kW
MOTOR CURRENT	MOTOR DATA	64	1.50 A	2.00 A	2.50 A	3.50 A	4.50 A	5.50 A
MAG CURRENT	MOTOR DATA	65	0.44 A	0.60 A	0.78 A	1.00 A	1.44 A	1.96 A
NAMEPLATE RPM	MOTOR DATA	83	1380.0 RPM	1400.0 RPM	1400.0 RPM	1420.0 RPM	1420.0 RPM	1420.0 RPM
MOTOR VOLTAGE	MOTOR DATA	1160	400.0 V	400.0 V	400.0 V	400.0 V	400.0 V	400.0 V
FREQUENCY	INJ BRAKING	577	9.0 Hz	9.0 Hz	9.0 Hz	9.0 Hz	9.0 Hz	9.0 Hz
DEFLUX TIME	INJ BRAKING	710	0.1 s	0.1 s	0.1 s	0.1 s	0.1 s	0.1 s
BASE VOLTS	INJ BRAKING	739	100.00 %	100.00 %	100.00 %	100.00 %	100.00 %	100.00 %
DC LEVEL	INJ BRAKING	581	3.0 %	3.0 %	3.0 %	3.0 %	3.0 %	3.0 %
DC PULSE	INJ BRAKING	579	2.0 s	2.0 s	2.0 s	2.0 s	2.0 s	2.0 s
FINAL DC PULSE	INJ BRAKING	580	1.0 s	1.0 s	1.0 s	1.0 s	1.0 s	1.0 s
FIXED BOOST	FLUXING	107	5.00 %	5.00 %	5.00 %	5.00 %	5.00 %	5.00 %
ACCEL TIME	REFERENCE RAMP	258	10.0 s	10.0 s	10.0 s	10.0 s	10.0 s	10.0 s
DECEL TIME	REFERENCE RAMP	259	10.0 s	10.0 s	10.0 s	10.0 s	10.0 s	10.0 s
DEFLUX DELAY	PATTERN GEN	100	1.0 s	1.0 s	1.0 s	1.0 s	1.0 s	1.0 s

400V Build Power Dependent Defaults						
			Frame 3			
Parameter	Function Block	Tag	3.0kW	4.0kW	5.5kW	7.5kW
MOTOR CURRENT	MOTOR DATA	64	6.80 A	9.00 A	12.00 A	16.00 A
MAG CURRENT	MOTOR DATA	65	2.36 A	3.36 A	3.39 A	4.38 A
NAMEPLATE RPM	MOTOR DATA	83	1420.0 RPM	1420.0 RPM	1445.0 RPM	1450.0 RPM
MOTOR VOLTAGE	MOTOR DATA	1160	400.0 V	400.0 V	400.0 V	400.0 V
FREQUENCY	INJ BRAKING	577	9.0 Hz	9.0 Hz	9.0 Hz	9.0 Hz
DEFLUX TIME	INJ BRAKING	710	0.5 s	0.5 s	0.5 s	0.5 s
BASE VOLTS	INJ BRAKING	739	100.00 %	100.00 %	100.00 %	100.00 %
DC LEVEL	INJ BRAKING	581	3.0 %	3.0 %	3.0 %	3.0 %
DC PULSE	INJ BRAKING	579	2.0 s	2.0 s	2.0 s	2.0 s
FINAL DC PULSE	INJ BRAKING	580	1.0 s	1.0 s	1.0 s	1.0 s
FIXED BOOST	FLUXING	107	3.00 %	3.00 %	3.00 %	3.00 %
ACCEL TIME	REFERENCE RAMP	258	10.0 s	10.0 s	10.0 s	10.0 s
DECEL TIME	REFERENCE RAMP	259	10.0 s	10.0 s	10.0 s	10.0 s
DEFLUX DELAY	PATTERN GEN	100	2.0s	2.0s	2.0s	2.0s

2-16 Parameter Specification

SERIAL COMMUNICATIONS

Communications Technology Options

Frames 1, 2 & 3 Option

RS232/RS485 Communication Module which fits to the front of the drive, replacing the keypad.

This option provides a serial data port allowing drives to be linked to form a network. Using a PLC/SCADA or other intelligent device, this network can be continuously controlled to provide supervision and monitoring for each drive in the system

Note: Refer to the RS485/RS232 Communications Interface Technical Manual, HA466357U001

Connection to the P3 Port

The port is an un-isolated RS232, 19200 Baud, supporting the standard EI bisynch ASCII and Modbus RTU communications protocols. Contact Eurotherm Drives for further information.

Using the P3 port on the drive, parameters can be monitored and updated by a suitable PC tool.

P3 Port

A standard P3 lead is used to connect to the drive.

P3 Port Pin	Lead	Signal
1	Black	0V
2	Red	5V
3	Green	TX
4	Yellow	RX

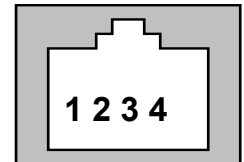

6-Way Lead to DB9/DB25 Connector

Note: There is 5V present on pin 2 of the P3 port - do not connect this to your PC.

P3 Port Pin	Lead	Female DB9 Pin	Female DB25 Pin
1	Black	5	7
2	Red	not connected	not connected
3	Green	2	3
4	Yellow	3	2

3-2 Serial Communications

SEQUENCING LOGIC STATES

Principle State Machine

The drive's reaction to commands is defined by a state machine. This determines which commands provide the demanded action, and in which sequence.

Main Sequencing States

The main sequencing state of the unit is indicated by an enumerated value given by the parameter SEQUENCER STATE in the SEQUENCING LOGIC function block.

Enumerated Value	Main Seq State	Standard Name	Description
0	START DISABLED	Switch On Disabled	The Inverter will not accept a switch on command
1	START ENABLED	Ready To Switch On	The Inverter will accept a switch on command
2	SWITCHED ON	Switched On	The Inverter's stack is enabled
3	READY	Ready	Waiting for Contactor to be closed
4	ENABLED	Enabled	The Inverter is enabled and operational
5	F-STOP ACTIVE	Fast-Stop Active	Fast stop is active
6	TRIP ACTIVE	Trip Active	The Inverter is processing a trip event
7	TRIPPED	Tripped	The Inverter is tripped awaiting trip reset

Table 4-1 Enumerated Values for the SEQUENCING LOGIC Function Block

State Outputs of the SEQUENCING LOGIC Function Block

The following table shows the states of individual parameters for the SEQUENCING LOGIC function block required to produce the condition of the MAIN SEQ STATE parameter.

	START DISABLED	START ENABLED	SWITCHED ON	READY	ENABLED	F-STOP ACTIVE	TRIP ACTIVE	TRIPPED
Tripped	FALSE	FALSE	FALSE	FALSE	FALSE	FALSE	TRUE	TRUE
Running	FALSE	FALSE	FALSE	FALSE	TRUE	FALSE	FALSE	FALSE
Jogging	FALSE	FALSE	FALSE	FALSE	Note 1	FALSE	FALSE	FALSE
Stopping	FALSE	FALSE	FALSE	FALSE	Note 2	TRUE	FALSE	FALSE
Output Contactor	Depends on previous state	Depends on previous state	TRUE	TRUE	TRUE	TRUE	TRUE	FALSE
Switch On Enable	FALSE	TRUE	TRUE	TRUE	TRUE	TRUE	TRUE	FALSE
Switched On	FALSE	FALSE	TRUE	TRUE	TRUE	TRUE	TRUE	FALSE
Ready	FALSE	FALSE	FALSE	TRUE	TRUE	TRUE	TRUE	FALSE
Healthy	TRUE	TRUE	TRUE	TRUE	TRUE	TRUE	FALSE	FALSE Note 3

Table 4-2 Parameter States for the MAIN SEQ STATE Parameter

Note: 1. *JOGGING* is set TRUE once the jog cycle has started, and remains TRUE until the jog cycle has finished which is when either the stop delay has finished or

4-2 Sequencing Logic

another mode is demanded.

2. *STOPPING* is set *TRUE* during the stopping cycles commanded by either *RUNNING* going low, *JOGGING* going low or if Fast Stop is active, i.e. *SEQUENCING LOGIC* is *F-STOP ACTIVE*.
3. Once Run and Jog are both *FALSE*, *HEALTHY O/P* will be set *TRUE*.

Transition of States

The transition matrix describes what causes the transition from one state to another, for example see no. 4 below: the transition from “Ready To Switch On” to “Trip Active” is triggered by “TRIP” going *TRUE*. Note – where a state has more than one exit transition, the transition with the lowest number has priority.

Refer to the following table and state diagram.

	Current State	Next State	Cause (FALSE to TRUE)
1	Power Up	Switch On Disabled	Power-Up, Restore Configuration or exit from Configuration mode.
2	Switch On Disabled	Trip Active	Trip
3	Switch On Disabled	Ready To Switch On	RUN = FALSE, JOG = FALSE, NOT FAST STOP = TRUE and NOT COAST STOP = TRUE
4	Ready To Switch On	Trip Active	Trip
5	Ready To Switch On	Switch On Disabled	NOT COAST STOP = FALSE or NOT FAST STOP = FALSE
6	Ready To Switch On	Switched On	RUN = TRUE or JOG = TRUE
7	Switched On	Trip Active	Trip (includes CONTACTOR CLOSED = FALSE after 10 seconds)
8	Switched On	Switch On Disabled	NOT COAST STOP = FALSE or NOT FAST STOP = FALSE
9	Switched On	Ready To Switch On	RUN = FALSE and JOG = FALSE
10	Switched On	Ready	CONTACTOR CLOSED = TRUE and defluxed
11	Ready	Trip Active	Trip (includes CONTACTOR CLOSED = FALSE)
12	Ready	Switch On Disabled	NOT COAST STOP = FALSE or NOT FAST STOP = FALSE
13	Ready	Ready To Switch On	RUN = FALSE and JOG = FALSE
14	Ready	Enabled	ENABLE = TRUE
15	Enabled	Trip Active	Trip (includes CONTACTOR CLOSED = FALSE)
16	Enabled	Switch On Disabled	NOT COAST STOP = FALSE
17	Enabled	Fast Stop Active	NOT FAST STOP = FALSE
18	Enabled	Ready To Switch On	RUN = FALSE, JOG = FALSE and stopping complete
19	Enabled	Ready	ENABLE = FALSE
20	Fast Stop Active	Trip Active	Trip (includes CONTACTOR CLOSED = FALSE)
21	Fast Stop Active	Switch On Disabled	Fast Stop timer expired or FAST STOP MODE = Coast Stop OR Inverter at zero setpoint
22	Trip Active	Tripped	Stack quenched
23	Tripped	Switch On Disabled	Trip = FALSE and TRIP RESET 0->1 transition

Table 4-3 Transition Matrix

State Diagram

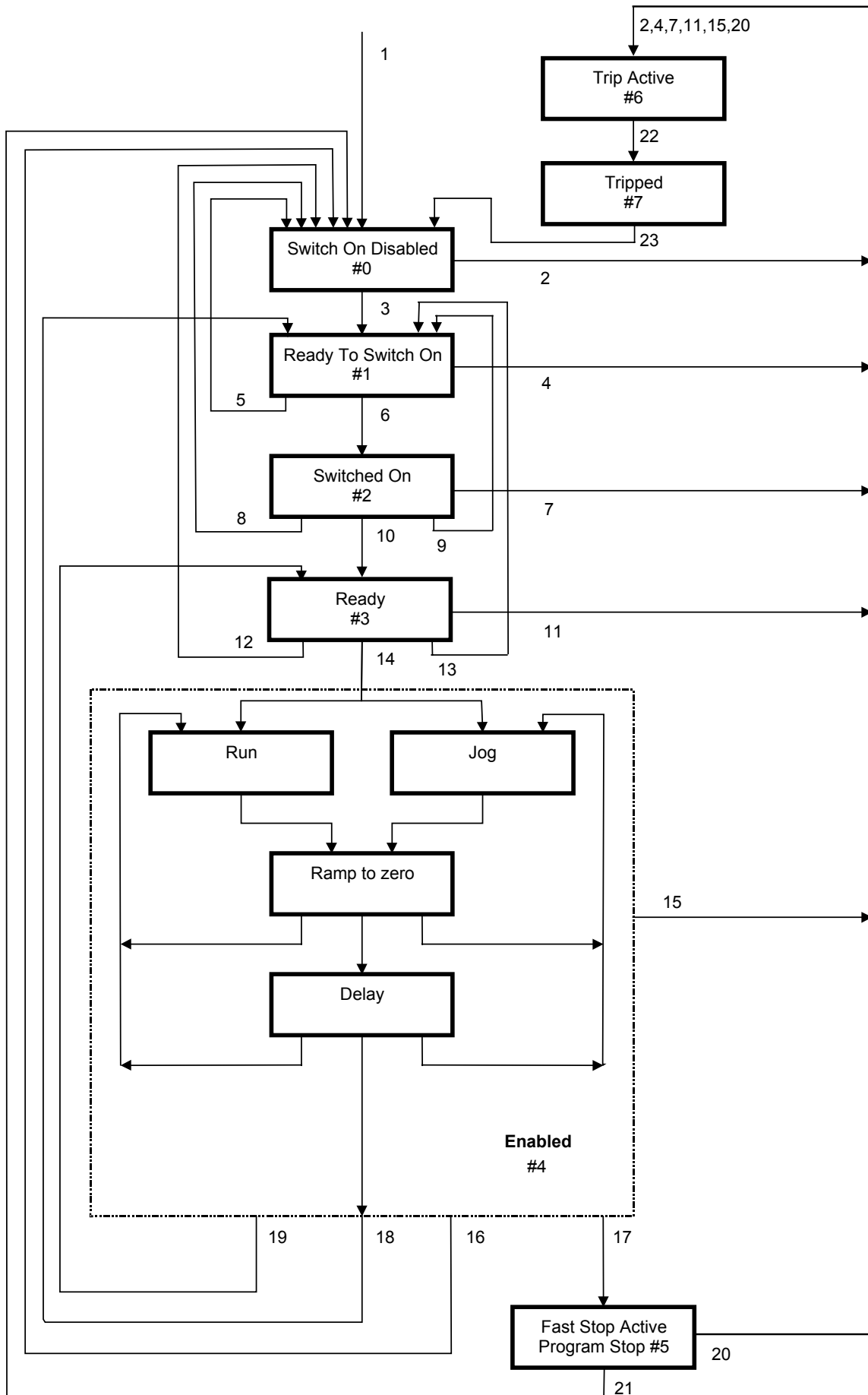

External Control of the Drive

Communications Command

When sequencing is in the Remote Comms mode, the sequencing of the Inverter is controlled by writing to the hidden parameter COMMS COMMAND (Tag 271). This parameter can only be written to using a communications interface. The output parameter (Tag 273) COMMS COMMAND of the COMMS CONTROL function block is provided as a diagnostic.

The COMMS COMMAND parameter is a 16-bit word based on standard fieldbus drive profiles. Some bits are not implemented in this release (see “Supported” column of the table below).

Bit	Name	Description	Supported	Required Value
0	Switch On	OFF1 Operational	√	
1	(Not) Disable Voltage	OFF2 Coast Stop	√	
2	(Not) Quick Stop	OFF3 Fast Stop	√	
3	Enable Operation		√	
4	Enable Ramp Output	=0 to set ramp output to zero		1
5	Enable Ramp	=0 to hold ramp		1
6	Enable Ramp Input	=0 to set ramp input to zero		1
7	Reset Fault	Reset on 0 to 1 transition	√	
8				0
9				0
10	Remote	=1 to control remotely		1
11				0
12				0
13				0
14				0
15				0

Switch On

Replaces the RUN FWD, RUN REV and NOT STOP parameters of the SEQUENCING LOGIC function block. When Set (=1) is the same as :

RUN FWD = TRUE
 RUN REV = FALSE
 NOT STOP = FALSE

When Cleared (= 0) is the same as :

RUN FWD = FALSE
 RUN REV = FALSE
 NOT STOP = FALSE

(Not) Disable Voltage

ANDed with the NOT COAST STOP parameter of the SEQUENCING LOGIC function block. When both Set (=1) is the same as:

NOT COAST STOP = TRUE

When either or both Cleared (= 0) is the same as :

NOT COAST STOP = FALSE

(Not) Quick Stop

ANDed with the NOT FAST STOP parameter on the SEQUENCING LOGIC function block.
When both Set (=1) is the same as:

NOT FAST STOP = TRUE

When either or both Cleared (= 0) is the same as :

NOT FAST STOP = FALSE

Enable Operation

ANDed with the DRIVE ENABLE parameter on the SEQUENCING LOGIC function block.
When both Set (=1) is the same as:

DRIVE ENABLE = TRUE

When either or both Cleared (= 0) is the same as :

DRIVE ENABLE = FALSE

Enable Ramp Output, Enable Ramp, Enable Ramp Input

Not implemented. The state of these bits must be set (=1) to allow this feature to be added in the future.

Reset Fault

Replaces the REM TRIP RESET parameter on the SEQUENCING LOGIC function block.
When Set (=1) is the same as:

REM TRIP RESET = TRUE

When Cleared (= 0) is the same as :

REM TRIP RESET = FALSE

Remote

Not implemented. It is intended to allow the PLC to toggle between local and remote. The state of this must be set (=1) to allow this feature to be added in the future.

Example Commands

047F hexadecimal to RUN

047E hexadecimal to STOP

4-6 Sequencing Logic

Communications Status

The COMMS STATUS parameter (Tag 272) in the COMMS CONTROL function block monitors the sequencing of the Inverter. It is a 16-bit word based on standard fieldbus drive profiles. Some bits are not implemented in the initial release and are set to 0 (see “Supported” column of the table below).

Bit	Name	Description	Supported
0	Ready To Switch On		√
1	Switched On	Ready for operation (refer control bit 0)	√
2	Operation Enabled	(refer control bit 3)	√
3	Fault	Tripped	√
4	(Not) Voltage Disabled	OFF 2 Command pending	√
5	(Not) Quick Stop	OFF 3 Command pending	√
6	Switch On Disable	Switch On Inhibited	√
7	Warning		
8	SP / PV in Range		
9	Remote	= 1 if Drive will accept Command Word	√
10	Setpoint Reached	The input is True if the system ramp output matches the demanded setpoint.	√
11	Internal Limit Active	This input is True if the internal current limit is active.	√
12			
13			
14			
15			

Ready To Switch On

Same as the SWITCH ON ENABLE output parameter of the SEQUENCING LOGIC function block.

Switched On

Same as the SWITCHED ON output parameter of the SEQUENCING LOGIC function block.

Operation Enabled

Same as the RUNNING output parameter of the SEQUENCING LOGIC function block.

Fault

Same as the TRIPPED output parameter of the SEQUENCING LOGIC function block.

(Not) Voltage Disabled

If in Remote Comms mode, this is the same as Bit 1 of the COMMS COMMAND parameter. Otherwise it is the same as the NOT COAST STOP input parameter of the SEQUENCING LOGIC function block.

(Not) Quick Stop

If in Remote Comms mode, this is the same as Bit 2 of the COMMS COMMAND parameter. Otherwise it is the same as the NOT FAST STOP input parameter of the SEQUENCING LOGIC function block.

Switch On Disable

Set (=1) only when in START DISABLED state, refer to Table 4-1.

Remote

This bit is set (= 1) if the Inverter is in Remote mode **AND** the parameter REMOTE COMMS SEL of the COMMS CONTROL function block is Set (= 1).

APPLICATIONS

The Default Application

The drive is supplied with 6 Applications, Application 0 to Application 5. Each Application recalls a pre-programmed set of parameters and internal links when it is loaded.

DEFAULT

- Application 0 will not control a motor. Loading Application 0 removes all internal links.
- Application 1 is the factory default application, providing for basic speed control
- Application 2 supplies speed control using a manual or auto setpoint
- Application 3 supplies speed control using preset speeds
- Application 4 is a set-up providing speed control with Raise/Lower Trim digital inputs
- Application 5 supplies speed control with PID control

How to Load an Application

The Applications are stored in the **PRF** menu.

From the **PRF** menu, go to parameter **P 1** by pressing the **M** key twice.

Use the **▲** **▼** keys to select the appropriate Application by number.

Press the **E** key to load the Application.

Note: To load a new Application using communications refer to the RS485/RS232 Communications Interface manual, HA466357U001.

Application Description

Note: Parameters whose default values are product-related are indicated in the block diagrams with * or **. Refer to Chapter 2: "Parameter Specification" - Product-Related Default Values.

5-2 Applications

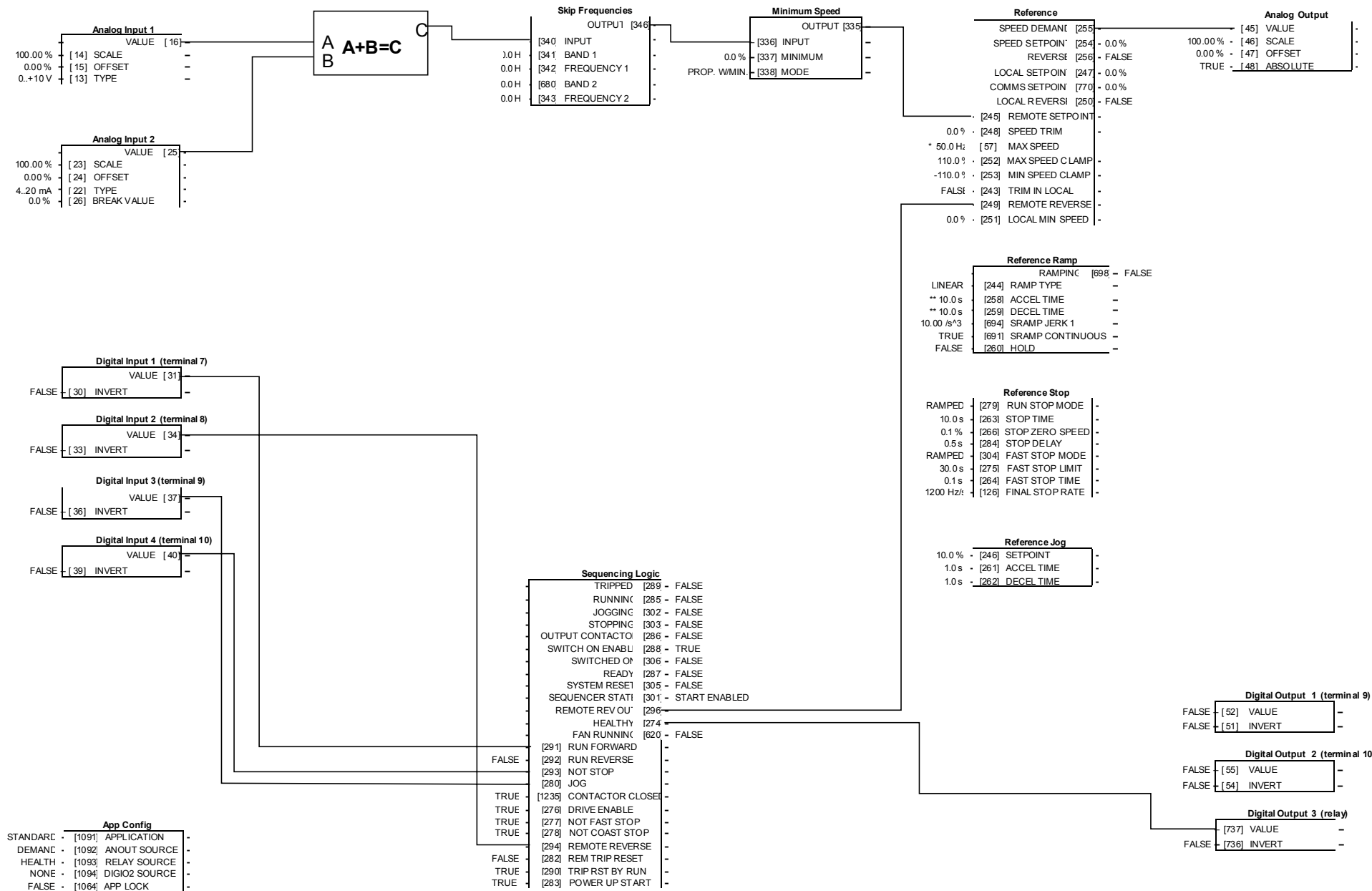

Application 1: Basic Speed Control (default)

Application 1: Basic Speed Control (default)

This Application is ideal for general purpose applications. It provides push-button or switched start/stop control. The setpoint is the sum of the two analogue inputs AIN1 and AIN2, providing Speed Setpoint + Speed Trim capability.

Control Wiring I/O			
Terminal	Name	Purpose	Comment
10	DIGITAL INPUT 4	Not Stop	24V = RUN FWD and RUN REV signals latched 0V = RUN FWD and RUN REV signals not latched
9	DIGITAL INPUT 3	Jog	24V = jog
8	DIGITAL INPUT 2	Direction	0V = remote forward 24V = remote reverse
7	DIGITAL INPUT 1	Run Forward	24V = run forward
5	ANALOG OUTPUT 1	Ramp Output	absolute speed demand 0V = 0%, 10V = 100%
3	ANALOG INPUT 2	Speed Trim	4mA = 0%, 20mA = 100%
2	ANALOG INPUT 1	Speed Setpoint	0V = 0%, 10V = 100%
RL1A RL1B	DIGITAL OUTPUT 3 (relay)	HEALTH	Open = tripped, i.e. not healthy

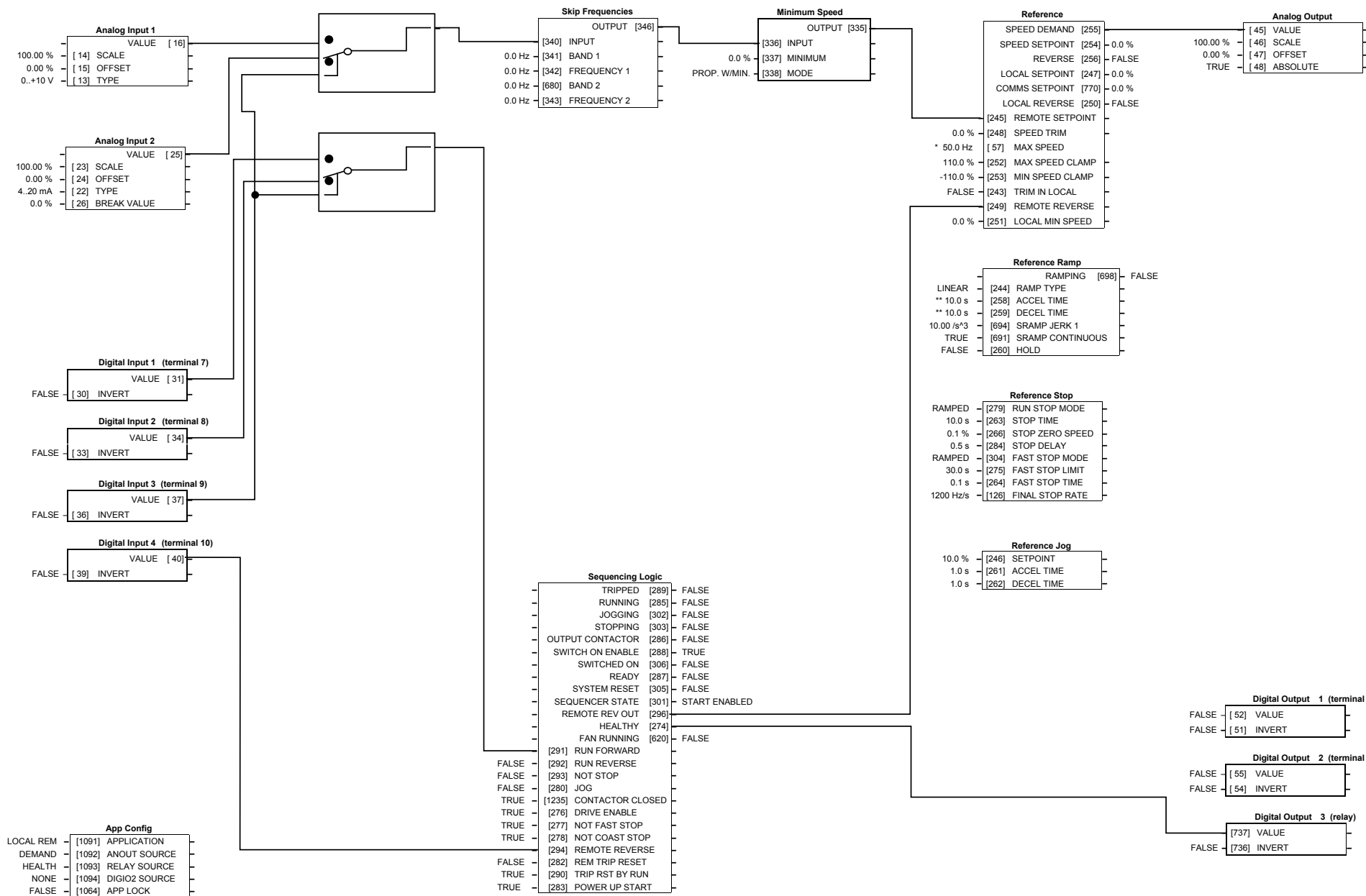

Application 2: Auto/Manual Control

Application 2: Auto/Manual Control

Two Run inputs and two Setpoint inputs are provided. The Auto/Manual switch selects which pair of inputs is active.

The Application is sometimes referred to as Local/Remote.

Control Wiring I/O			
Terminal	Name	Purpose	Comment
10	DIGITAL INPUT 4	Remote Reverse	0V = remote forward 24V = remote reverse
9	DIGITAL INPUT 3	Select	24V = run forward
8	DIGITAL INPUT 2	Auto Run	
7	DIGITAL INPUT 1	Manual Run	
5	ANALOG OUTPUT 1	Ramp Output	absolute speed demand 0V = 0%, 10V = 100%
3	ANALOG INPUT 2	Auto Setpoint	4mA = 0%, 20mA = 100%
2	ANALOG INPUT 1	Manual Setpoint	0V = 0%, 10V = 100%
RL1A RL1B	DIGITAL OUTPUT 3 (relay)	HEALTH	Open = tripped, i.e. not healthy

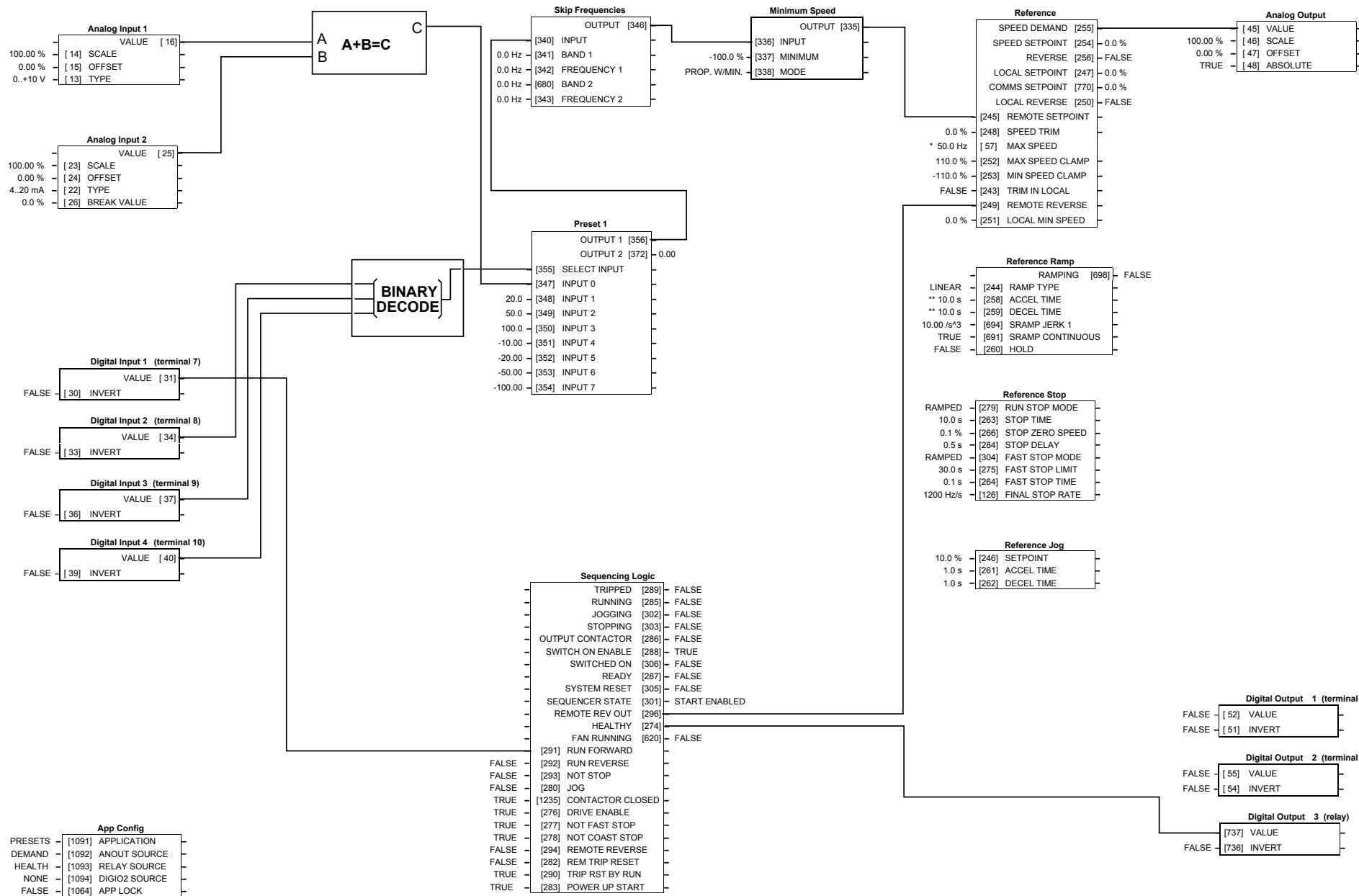

Application 3: Preset Speeds

Application 3: Preset Speeds

This is ideal for applications requiring multiple discrete speed levels.

The setpoint is selected from either the sum of the analogue inputs, (as in Application 1 and known here as PRESET 0), or as one of up to seven other pre-defined speed levels. These are selected using DIN2, DIN3 and DIN4, refer to the Truth Table below.

Edit parameter ^P302 on the keypad to re-define the speed levels of PRESET. Reverse direction is achieved by entering a negative speed setpoint.

Control Wiring I/O			
Terminal	Name	Purpose	Comment
10 9 8	DIGITAL INPUT 4 DIGITAL INPUT 3 DIGITAL INPUT 2	Preset Select 3 Preset Select 2 Preset Select 1	Preset Speed Select Preset Speed Select Preset Speed Select
7	DIGITAL INPUT 1	Run Forward	24V = run forward
5	ANALOG OUTPUT 1	Ramp Output	absolute speed demand 0V = 0%, 10V = 100%
3	ANALOG INPUT 2	Speed Trim	4mA = 0%, 20mA = 100%
2	ANALOG INPUT 1	Speed Setpoint	0V = 0%, 10V = 100%
RL1A RL1B	DIGITAL OUTPUT 3 (relay)	HEALTH	Open = tripped, i.e. not healthy

Preset Speed Truth Table

DIN4/DOUT2	DIN3	DIN2	Preset
0V	0V	0V	0
0V	0V	24V	1
0V	24V	0V	2
0V	24V	24V	3
24V	0V	0V	4
24V	0V	24V	5
24V	24V	0V	6
24V	24V	24V	7

Application 4: Raise/Lower Trim

This Application mimics the operation of a motorised potentiometer. Digital inputs allow the setpoint to be increased and decreased between limits. The limits and ramp rate can be set using the keypad.

The Application is sometimes referred to as Motorised Potentiometer.

Control Wiring I/O			
Terminal	Name	Purpose	Comment
10	DIGITAL INPUT 4	Reset	24V = reset Raise/Lower
9	DIGITAL INPUT 3	Lower Input	24V = Lower input
8	DIGITAL INPUT 2	Raise Input	24V = raise input
7	DIGITAL INPUT 1	Run Forward	24V = run forward
5	ANALOG OUTPUT 1	Ramp Output	absolute speed demand 0V = 0%, 10V = 100%
RL1A RL1B	DIGITAL OUTPUT 3 (relay)	HEALTH	Open = tripped, i.e. not healthy

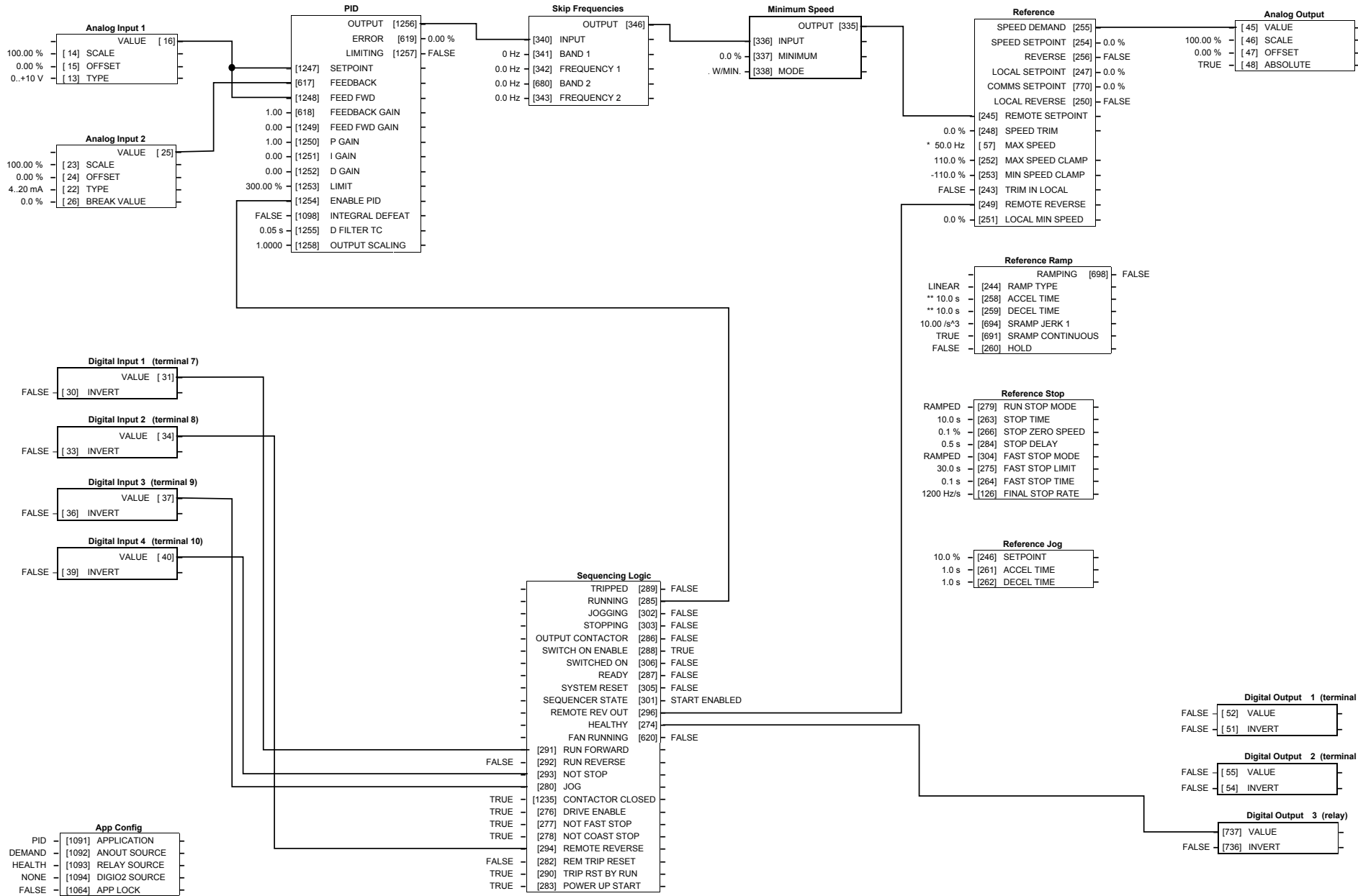

Application 5: PID

Application 5: PID

A simple application using a Proportional-Integral-Derivative 3-term controller. The setpoint is taken from AIN1, with feedback signal from the process on AIN2. The scale and offset features of the analogue input blocks may be used to correctly scale these signals. The difference between these two signals is taken as the PID error. The output of the PID block is then used as the drive setpoint.

Control Wiring I/O			
Terminal	Name	Purpose	Comment
10	DIGITAL INPUT 4	Not Stop	24V = RUN FWD and RUN REV signals latched 0V = RUN FWD and RUN REV signals not latched
9	DIGITAL INPUT 3	Jog	24V = jog
8	DIGITAL INPUT 2	Remote Reverse	0V = remote forward 24V = remote reverse
7	DIGITAL INPUT 1	Run Forward	24V = run forward
5	ANALOG OUTPUT 1	Ramp Output	absolute speed demand 0V = 0%, 10V = 100%
3	ANALOG INPUT 2	Process Feedback	0V = 0%, 10V = 100%
2	ANALOG INPUT 1	Process Setpoint	0V = 0%, 10V = 100%
RL1A RL1B	DIGITAL OUTPUT 3 (relay)	HEALTH	Open = tripped, i.e. not healthy

Sequencing and Reference

<p>Auto Restart</p> <ul style="list-style-type: none"> · PENDING [608] - FALSE · RESTARTING [616] - FALSE · ATTEMPTS LEFT [614] - 0 · TIME LEFT [615] - 0.0 s 0 · [612] ATTEMPTS - 10.0 s · [613] ATTEMPT DELAY 1 - 0x0000 · [609] TRIGGERS 1 - 0x0000 · [744] TRIGGERS 1+ - 	<p>Reference</p> <ul style="list-style-type: none"> SPEED DEMAND [255] - 0.0 % SPEED SETPOINT [254] - 0.0 % REVERSE [256] - FALSE LOCAL SETPOINT [247] - 0.0 % COMMS SETPOINT [770] - 0.0 % LOCAL REVERSE [250] - FALSE 0.0 % [245] REMOTE SETPOINT - 0.0 % [248] SPEED TRIM - * 50.0 Hz [57] MAX SPEED - 110.0 % [252] MAX SPEED CLAMP - -110.0 % [253] MIN SPEED CLAMP - FALSE [243] TRIM IN LOCAL - FALSE [249] REMOTE REVERSE - 0.0 % [251] LOCAL MIN SPEED - 	<p>Reference Ramp</p> <ul style="list-style-type: none"> RAMPING [698] - FALSE LINEAR [244] RAMP TYPE - ** 10.0 s [258] ACCEL TIME - ** 10.0 s [259] DECEL TIME - 0.00 /s² [694] SRAMP JERK 1 - TRUE [691] SRAMP CONTINUOUS - FALSE [260] HOLD - 	<p>Sequencing Logic</p> <ul style="list-style-type: none"> TRIPPER [289] - FALSE RUNNING [285] - FALSE JOGGING [302] - FALSE STOPPING [303] - FALSE OUTPUT CONTACTOR [286] - FALSE SWITCH ON ENABL [288] - TRUE SWITCHED OFF [306] - FALSE READY [287] - FALSE SYSTEM RESET [305] - FALSE SEQUENCER START [301] - START ENABLED REMOTE REV OUV [296] - FALSE HEALTHY [274] - TRUE FAN RUNNING [620] - FALSE [291] RUN FORWARD - [292] RUN REVERSE - [293] NOT STOP - [280] JOG - [1235] CONTACTOR CLOSE - [276] DRIVE ENABLE - [277] NOT FAST STOP - [278] NOT COAST STOP - [294] REMOTE REVERSE - [282] REM TRIP RESET - [290] TRIP RST BY RUN - [283] POWER UP START -
<p>Comms Control</p> <ul style="list-style-type: none"> COMMS SEQ [295] - FALSE COMMS REF [270] - FALSE COMMS STATUS [272] - 0x0031 COMMS COMMAND [273] - 0x0000 FALSE [300] REMOTE COMMS SEL - TERMINALS/COMMS [307] REMOTE SEQ MODES - TERMINALS/COMMS [308] REMOTE REF MODES - 0.0 s [309] COMMS TIMEOUT - 	<p>Local Control</p> <ul style="list-style-type: none"> REMOTE SEC [297] - FALSE REMOTE REI [257] - FALSE LOCAL/REMOTE [298] SEQ MODES - LOCAL/REMOTE [265] REF MODES - AUTOMATIC [299] POWER UP MODE - FALSE [281] SEQ DIRECTION - 	<p>Reference Stop</p> <ul style="list-style-type: none"> [279] RUN STOP MODE - [263] STOP TIME - [266] STOP ZERO SPEED - FALSE [284] STOP DELAY - FALSE [304] FAST STOP MODE - FALSE [275] FAST STOP LIMIT - FALSE [264] FAST STOP TIME - TRUE [126] FINAL STOP RATE - TRUE 1200 Hz [276] DRIVE ENABLE - TRUE [277] NOT FAST STOP - TRUE [278] NOT COAST STOP - FALSE [294] REMOTE REVERSE - FALSE [282] REM TRIP RESET - TRUE [290] TRIP RST BY RUN - TRUE [283] POWER UP START - TRUE 	
<p>Reference Jog</p> <ul style="list-style-type: none"> 10.0 % [246] SETPOINT - 1.0 s [261] ACCEL TIME - 1.0 s [262] DECEL TIME - 			

Motor Control

<p>Dynamic Braking</p> <ul style="list-style-type: none"> TRUE [80] BRAKING [81] - [80] ENABLE - 100 Ohm [77] BRAKE RESISTANCE - 0.1 kW [78] BRAKE POWER - 25 [79] 1SEC OVER RATING - 	<p>Fluxing</p> <ul style="list-style-type: none"> LINEAR LAW [104] V/F SHAPE - ** 0.00 % [107] FIXED BOOST - 0.00 % [108] AUTO BOOST - FALSE [1058] 601 FLUXING - FALSE [1655] ENERGY SAVING - 	<p>Motor Data</p> <ul style="list-style-type: none"> * 50.0 Hz [1159] BASE FREQUENCY - 400.0 V [1160] MOTOR VOLTAGE - ** 20.00 A [64] MOTOR CURRENT - 6.00 A [65] MAG CURRENT - 1460.0 rpm [83] NAMEPLATE RPM - 4 POLE [84] MOTOR POLES - VOLTS / HZ [1157] CONTROL MODE - 11.00 kW [1158] POWER - STAR [124] MOTOR CONNECTION - 0.86 [242] POWER FACTOR - 2.0 [1164] OVERLOAD - 0.7698 Ohm [119] STATOR RES - 24.50 mH [120] LEAKAGE INDUCT - 98.01 mH [121] MUTUAL INDUCT - 379.56 ms [1163] ROTOR TIME CONST -
<p>Feedbacks</p> <ul style="list-style-type: none"> DC LINK VOLTS [75] - 700 V MOTOR CURRENT % [66] - 0.0 % MOTOR CURRENT A [67] - 0.0 A TERMINAL VOLTS [1020] - 0 V SPEED FBK RPM [569] - 0.00 RPM SPEED FBK REV/S [568] - 0.00 Hz SPEED FBK % [749] - 0.00 % TORQUE FEEDBACK [70] - 0.00 % FIELD FEEDBACK [73] - 0.00 % FALSE [50] NORMAL DUTY - 	<p>Pattern Gen</p> <ul style="list-style-type: none"> TRUE [98] DRIVE FREQUENCY [591] - 0.0 Hz 2.0 s [100] RANDOM PATTERN - [100] DEFLUX DELAY - 	

Application Control Blocks

Some of these blocks may already be in use by the Applications

Setpoint Functions

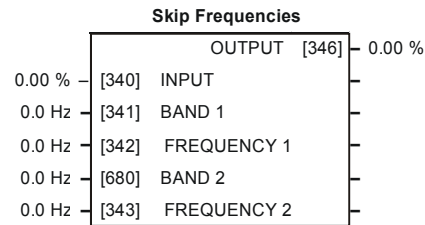
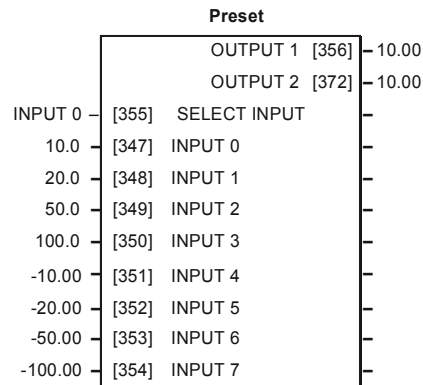
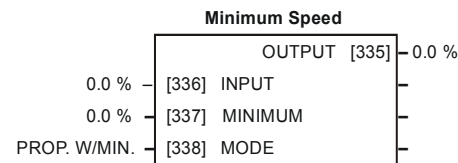
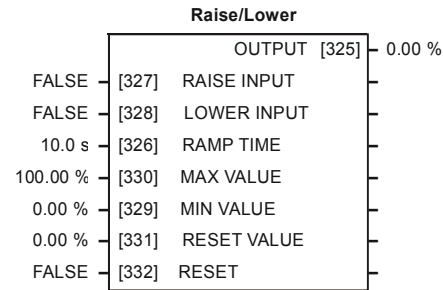
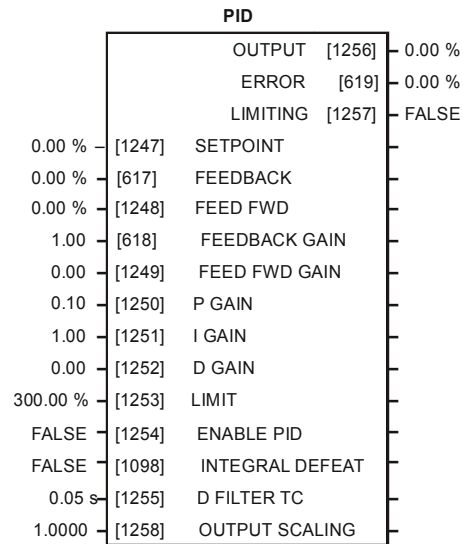

Trips

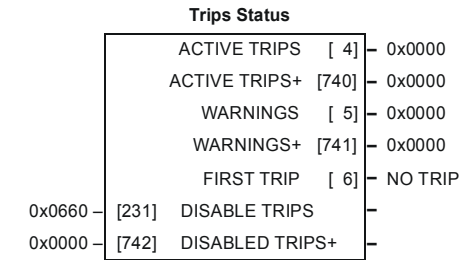

Communications

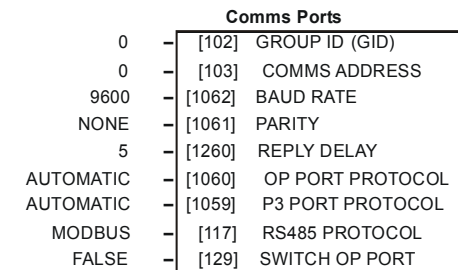

Application Control Blocks

Some of these blocks may already be in use by the Applications

Menus

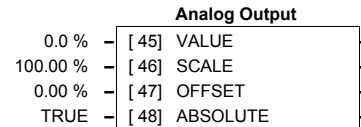
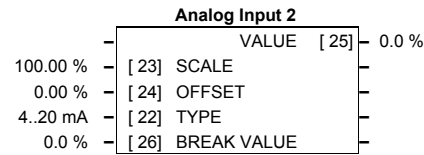
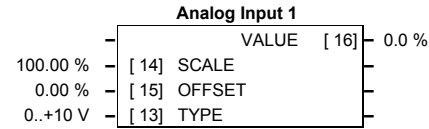
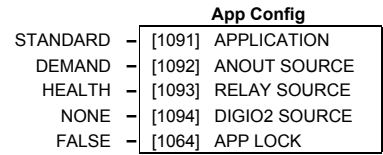
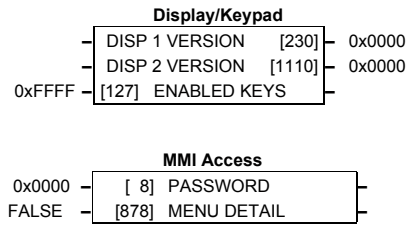

Inputs and Outputs

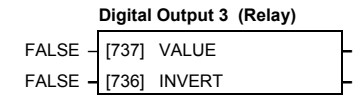
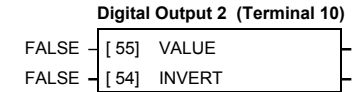
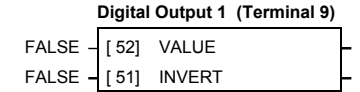
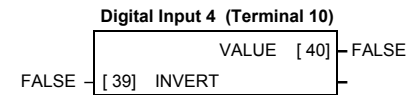
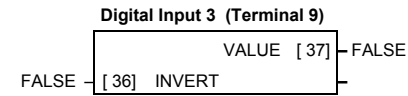
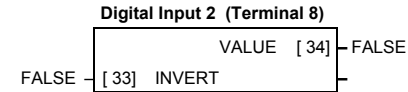
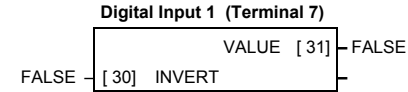

Some of these blocks may already be in use by the Applications

Application Control Blocks

ISS.	MODIFICATION	ECN No.	DATE	DRAWN	CHK'D
1	First release of new manual HA467872U001	13341	9/8/02	CM	JA
2	Minor amendments - Modbus notes, page 2-1 Also pages 1-7, 1-19, 1-33.	17556	13/5/03	CM	JA
3	Removal of "Config Ed" from manual.	17669	17/7/03	CM	JA
4	Software upgrade to 4.7; MAX SPEED range change p1-28	17893	8/6/04	CM	JA
5	Update for sv4.8 onwards. Company name change.	18825 (18354)	14/07/05	CM	JA
FIRST USED ON		MODIFICATION RECORD			
		650 AC Drive Software Product Manual Frames 1, 2, 3			
 EUROTHERM DRIVES		DRAWING NUMBER ZZ467872U001			SHT. 1 OF 1

