

631

Series



GETTING STARTED

Introduction

The 631 Digital Servo Drive is designed to control Eurotherm approved AC Brushless Servo Motors. It is available in a range of current ratings from 1 to 6 Amps.

Set-up

The EASYRIDER software  is used to set-up the drive. An “Autopilot” set-up wizard can be started when using the software.

Programming

The “BIAS” programming language is contained in EASYRIDER  which provides for up to 1500 lines of program code.

Operation

The unit is operated remotely using the analog/digital inputs and outputs via a PLC, for example. Multiple units can be controlled using RS232, CAN-Bus or Incremental Bus.

Four operating modes offer various speed, torque and position controls.

There is a seven-segment diagnostic display for trip and fault finding information.

The internal RFI filter offers enhanced EMC compliance without the need for additional external components.

An internal dynamic brake resistor is provided.

Equipment Inspection

- Check for signs of transit damage
- Check the product code on the rating label conforms to your requirement.

If the unit is not being installed immediately, store the unit in a well-ventilated place away from high temperatures, humidity, dust, or metal particles.

Refer to Chapter 2: “An Overview of the Servo Drive” to check the rating label/product code.

Refer to Chapter 8: “Routine Maintenance and Repair” for information on returning damaged goods.

Refer to Chapter 9: “Accessories” to check for the correct items.

About this Manual

This manual is intended for use by the installer, user and programmer of the 631 Servo Drive. It assumes a reasonable level of understanding in these three disciplines.

Note: *Please read all Safety Information before proceeding with the installation and operation of this unit.*

Enter the “Model No” from the rating label into the table at the front of this manual. It is important that you pass this manual on to any new user of this unit.

Initial Steps

Use the manual to help you plan the following:

Installation

Know your requirements:

- certification requirements, CE/UL/CUL conformance
- conformance with local installation requirements
- supply and cabling requirements

1-2 Getting Started

Operation

Know your operator:

- how is it to be operated, RS232, CAN-Bus?
- what level of user is going to operate the unit?

Programming (Operator Station or suitable PC programming tool only)

Know your application:









- select the appropriate Operating Mode
- plan your “programming”
- enter a password to guard against illicit or accidental damage

How the Manual is Organised

The manual is divided into chapters and paragraphs. Page numbering restarts with every chapter, i.e. 5-3 is Chapter 5, page 3.

Further descriptions,
that relate to this document.

Associated Documentation

UL:4.2.2 	Absolute encoder with CAN
UL:7.5.3.3 	Bus Interface CAN for 631
UL:9.5.1 	Intelligent Operator-Terminal IBT - Product Description
UL: 10.6.4 	EASYRIDER software
UL: 10.6.5 	BIAS - Command Description
UL: 10.6.6 	Serial transfer protocol EASY-serial 631 - Product Manual
UL: 12 	Accessories
HA388879 	EMC Installation Guidelines for Modules and Systems

AN OVERVIEW OF THE SERVO DRIVE

Component Identification

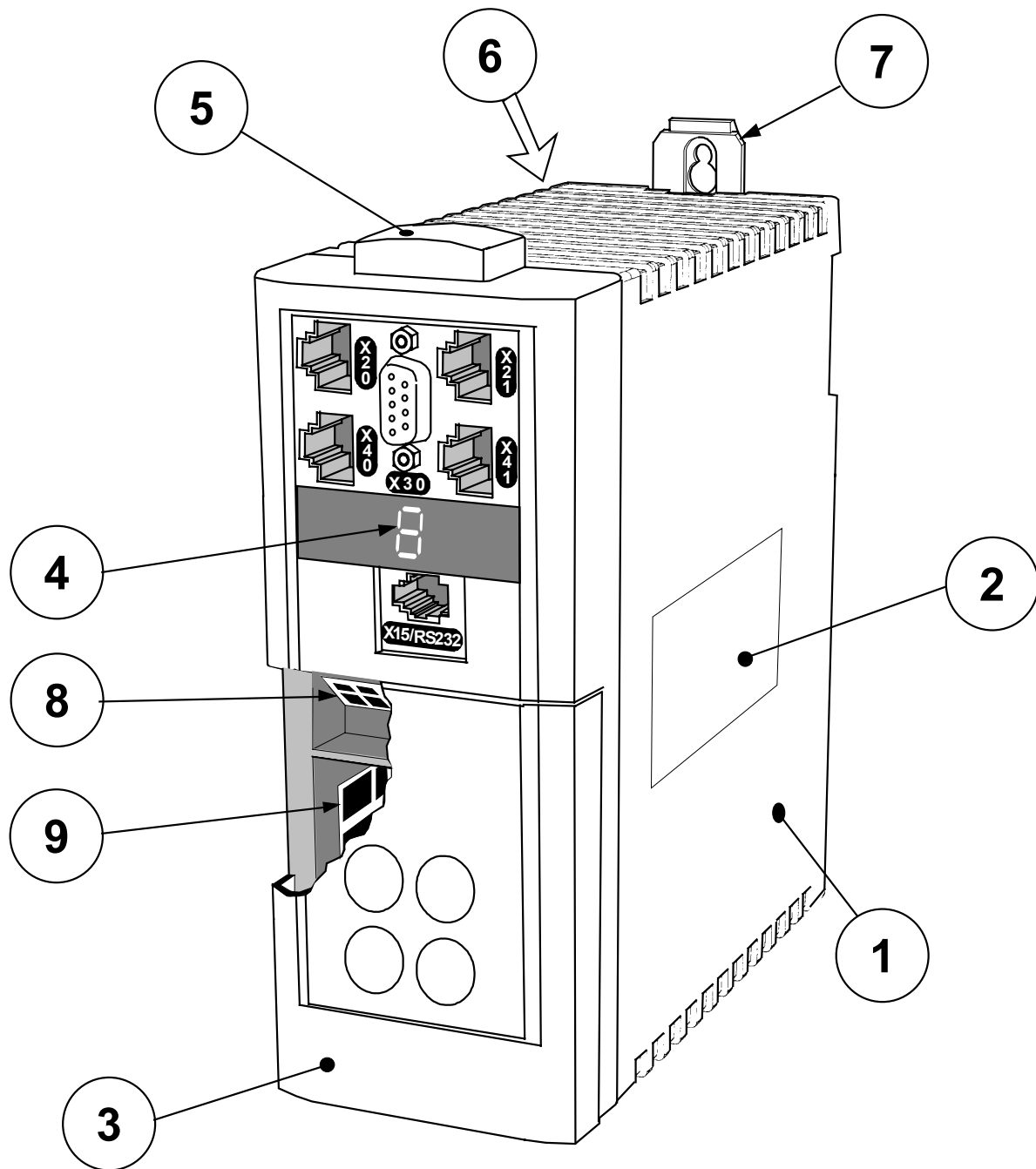

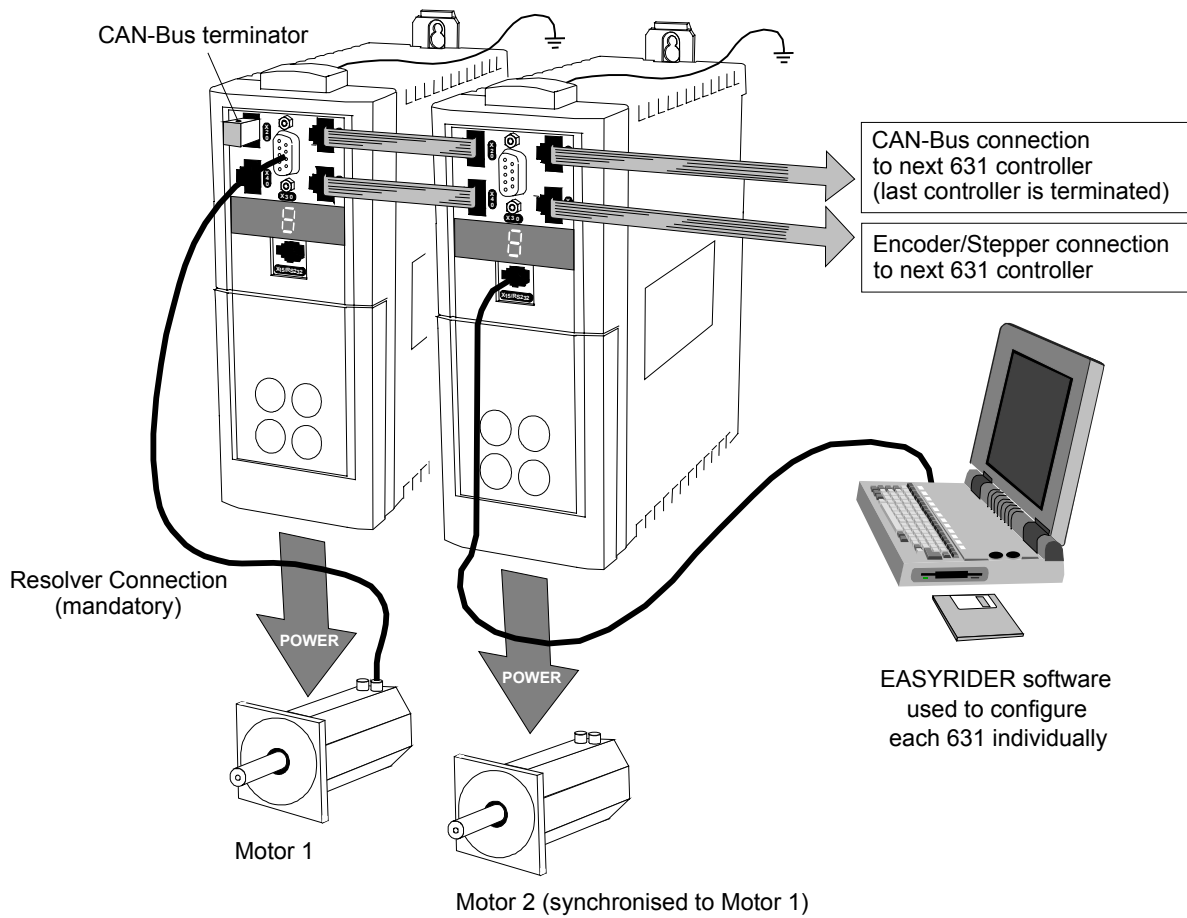

Figure 2-1 View of Component Parts

1	Main servo drive assembly	9	Power terminal (X1)
2	Product code label	X15/RS232	Set-up service connection (EASYSIDER )
3	Terminal cover	X20	CAN-Bus input connection
4	Diagnostic display	X21	CAN-Bus output connection
5	Electronic ground connection	X30	Resolver connection
6	External brake resistor connection	X40	Pulse interface, multi-function, input connection
7	Adjustable mounting clip	X41	Pulse interface, multi-function, output connection
8	Control terminal (X10)		

2-2 An Overview of the Servo Drive

Control Features



The Servo Drive is controlled via RS232, CAN-Bus or Incremental Bus using a PLC. It is configured using the EASYRIDER software.

General	Operating Modes	Pulse/direction Input ±10V velocity control Torque control Position control Encoder follower Motion control BIAS - motion language CAM profiling
	Setup, Service, Programming	EASYRIDER software
	Communications Interfaces	CAN-Bus RS232 Incremental Bus
	Diagnostics	Diagnostic facility
Protection	Trip Conditions Functions	Heatsink overtemperature and Multiple protection functions - refer to Chapter 7
Inputs/Outputs	Inputs	±10V (12 bit) setpoint 4 In: 24V DC
	Outputs	2 Out: 24V DC

Table 2-1 Control Features

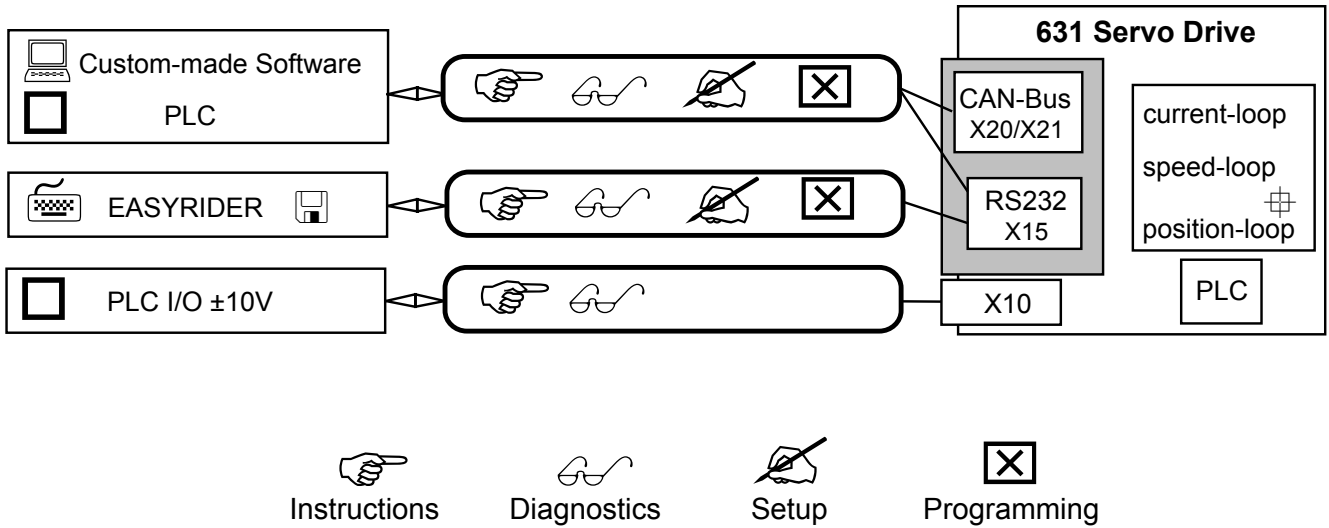

Figure 2-2 Communications Options

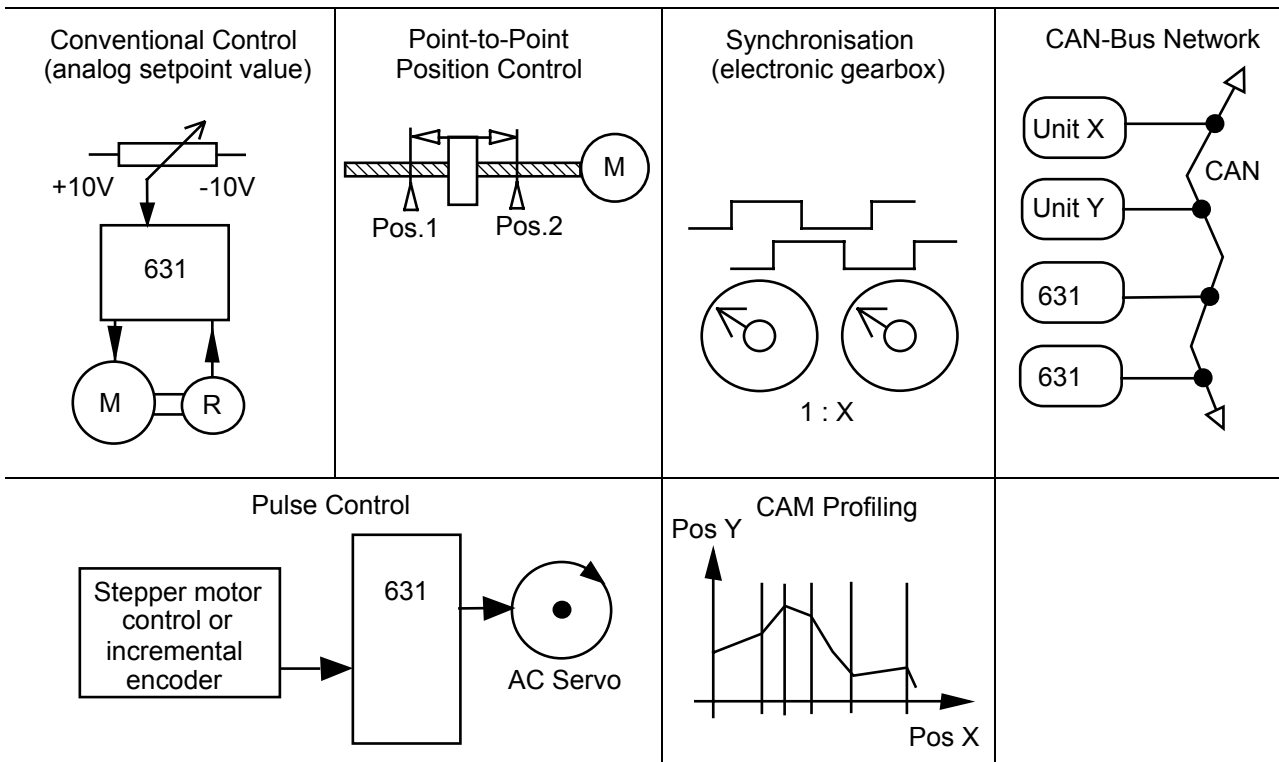

Figure 2-3 Typical Applications

2-4 An Overview of the Servo Drive

Understanding the Product Code

The unit is fully identified using a five block alphanumeric code which records how the Servo Drive was calibrated, and its various settings when despatched from the factory.

The Product Code appears as the “Model No.”. Each block of the Product Code is identified as below:

Order No: 150972 Item No: 1.1 Unit No:1 of 1					
Customer: EURO THERM DRIVES LTD					
Customer Order No: PAS(NIRL631)					
Model No: 631/002/230/F/00					
Input Volts	220-240	Vac 1ph 50/60Hz	Input Current	3.8	Amps
Output Volts	0..210-230	Vac 3ph 0..600Hz	Output Current	2.0	Amps
Serial No: 15097201001069					
Despatch Transaction:					

Block No.	Variable	Description
1	631	Generic product
2	XXX	Three numbers specifying the rated output current 001 = 1A 002 = 2A 004 = 4A 006 = 6A
3	XXX	Three numbers specifying the nominal input voltage rating: 230 220 to 240V (±10%) 50/60Hz
4	X	One character specifying the use of the Internal EMC RFI Filter: F = Filter 0 = No Filter
5	XX	Two digits specifying mechanical package including livery and mechanical package style, and any option installed over and above the standard features of the product: 00 Eurotherm Standard

Example



631/002/230/F/00

Servo Drive Type 631, rated output current 2A, AC supply 230V, with internal filter.

INSTALLING THE SERVO DRIVE

IMPORTANT: Read Chapter 12: "Certification for the Servo Drive" before installing this unit.

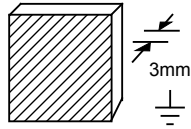
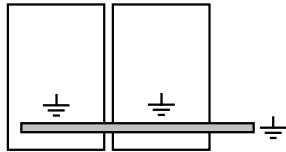
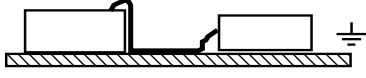
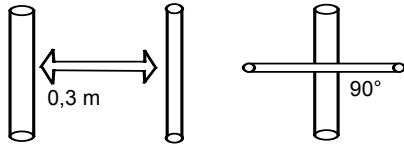
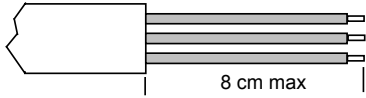
EMC Installation Hints

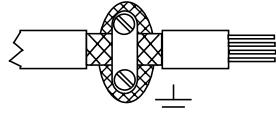
<p>All components are mounted on a mounting plate (minimum thickness 3mm) inside a steel cubicle.</p>	
<p>Ensure good grounding of the complete system, including the ground connections between the cubicle and machine.</p> <p>If more than one mounting plate, interconnect with copper rails.</p>	
<p>Place all wires and cables as close as possible to any grounded metal planes. Position control cables close to grounded metal parts when exiting the control cubicle.</p>	
<p>Separate "dirty", "clean" and "sensitive" cables if possible by at least 30mm. Cables should cross at 90°.</p> <p>Avoid cable loops, especially between the line filter and drive which should be as close and as short as possible (drilled).</p>	
<p>Only remove the required length of screen from the end of the cable.</p>	
<p>Make screen connections as advised in this manual. Keep screened cables as short as possible, ground screens at both ends. For long cables, make additional screened connections along the cable length.</p>	
<p>Connect screens to good quality grounding points. Use U-clips to give a 360° connection.</p> <p>Connect any unused wires in the cables to ground.</p>	
<p>Use only Eurotherm cables for motor and resolver.</p>	<p>Refer to Chapter 9: "Accessories"</p>

3-2 Installing the Servo Drive

Mechanical Installation

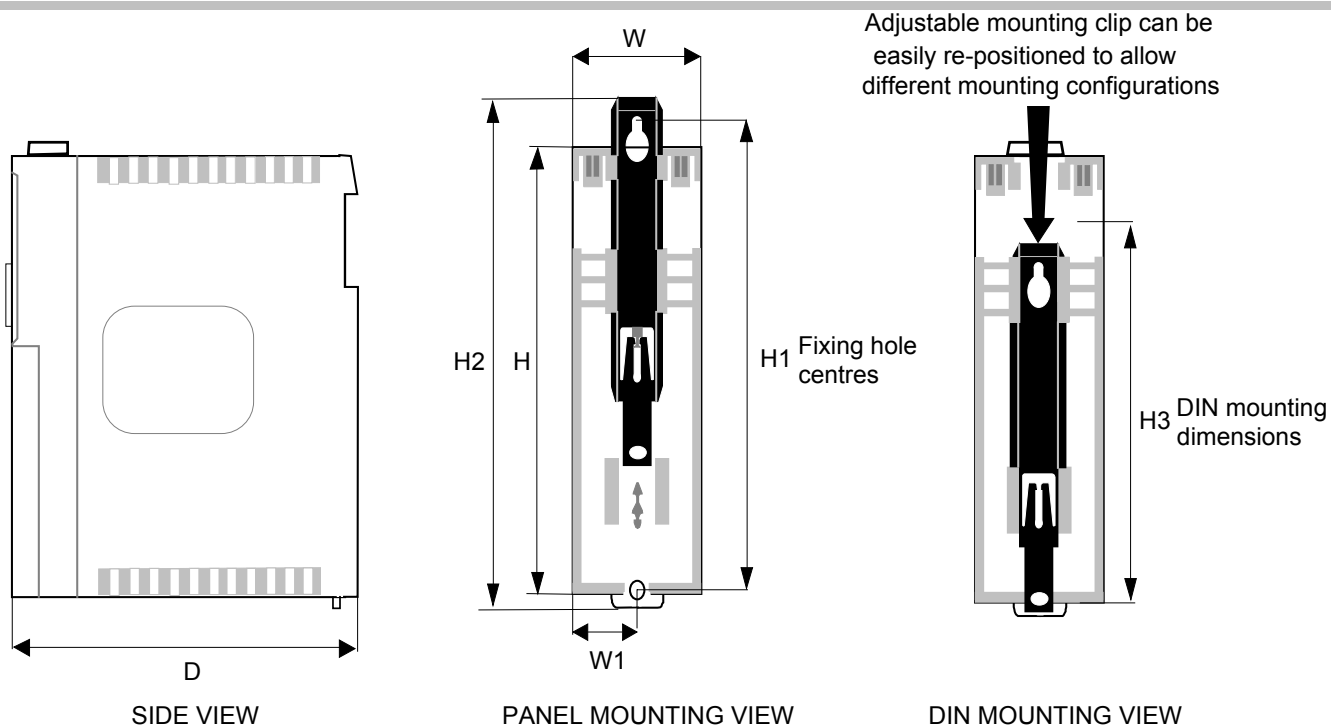

Figure 3-1 Mechanical Dimensions for 631

631 Model Number	H	H1	H2	H3	W	W1	D	Fixings
631 /001 /230/	183.0 (7.2)	188.0 (7.4)	205.0 (8.1)	151.0 (5.9)	72.0 (2.8)	36.0 (1.4)	175.0 (6.9)	Mounting holes 5.5mm Use M5 fixings Weight 1.5kg (3.3lb) approximately
631 /002/ 230/								
631 /004/ 230/								
631 /006/ 230/								
All dimensions are in millimetres (inches)								

Note: Additional space is required to the front of the unit for the signal mating plugs, approximately 45mm.

Mounting the Servo Drive

The unit must be installed in a vertical position to guarantee the best air circulation for the cooling ribs of the heat sink. Vertical installation above other drive racks or above other heat producing devices can lead to overheating.

You must install the unit inside a suitable cubicle. The inside of this cubicle must be free from dust, corrosive fumes, gases, and all liquids including condensation.

If the unit is being installed in a place where condensation is likely, install a suitable anticondensation heater. The heater must be SWITCHED OFF during normal operation. Automatic switch off is recommended.

Minimum Air Clearances

Cubicle Size

The digital servo drive is protected against damage caused by overheating.

There is a thermal sensor installed on the heat sink. When the temperature rises to $>95^{\circ}\text{C}$, the drive is automatically switched off. This setting cannot be changed. Use a cabinet of the correct size for adequate air circulation, see below.

631 Model Number	Volume of Cubicle (minimum)
631 /001 /230/	0.12m ³
631 /002/ 230/	
631 /004/ 230/	
631 /006/ 230/	

Ventilation

The servo drive gives off heat in normal operation and must therefore be mounted to allow the free flow of air through the ventilation slots and heatsink. Maintain minimum clearances for ventilation as shown below to ensure heat generated by other adjacent equipment is not transmitted to the Servo Drive. Be aware that other equipment may have its own clearance requirements. When mounting two or more 631s together, these clearances are additive.

Ensure that the mounting surface is normally cool.

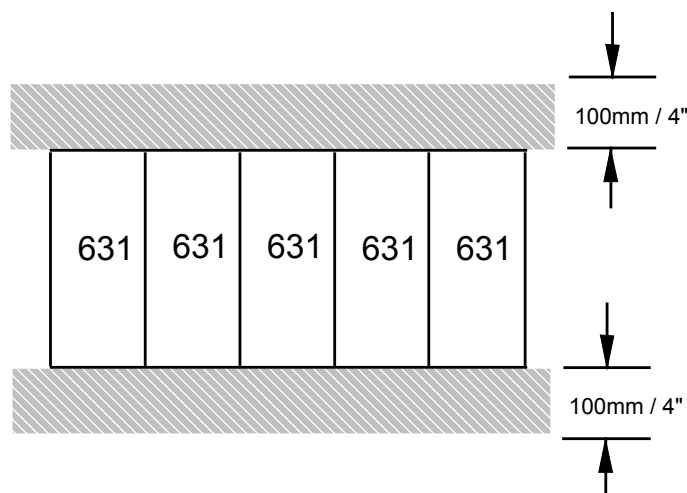

General Rule:

It is better to place heat-producing devices low down inside an enclosure to support internal convection, which will spread the heat. If placing devices up high is unavoidable, you should consider increasing the (upper) dimensions of the cubicle, or installing fans.

3-4 Installing the Servo Drive

Electrical Installation

IMPORTANT: Please read the Safety Information on page Cont. 3 & 4 before proceeding.

WARNING!

Ensure that all wiring is electrically isolated and cannot be made "live" unintentionally by other personnel.

All control/resolver/motor thermistor inputs,
i.e protected by double insulation are SELV.
Do not connect to non-SELV circuits.

(Refer to Chapter 11: "Technical Specifications" - Insulation Concept).

Note: Refer to Chapter 11: "Technical Specifications" for additional Cabling Requirements and Terminal Block Wire Sizes.

IMPORTANT: The use of variable speed drives of all kinds can invalidate the certification for dangerous areas (apparatus group and/or temperature class) of explosion-protected motors. Inspection and certification for the complete installation of servo motors and electronic components **must** be obtained.

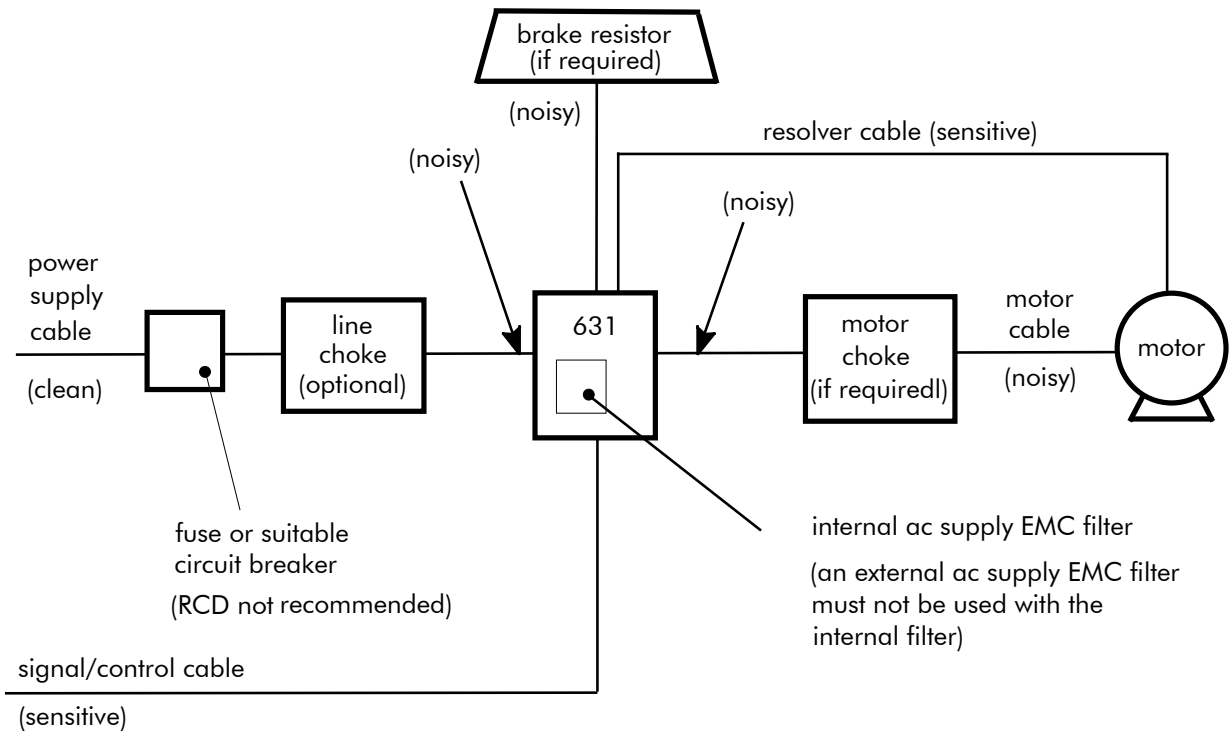
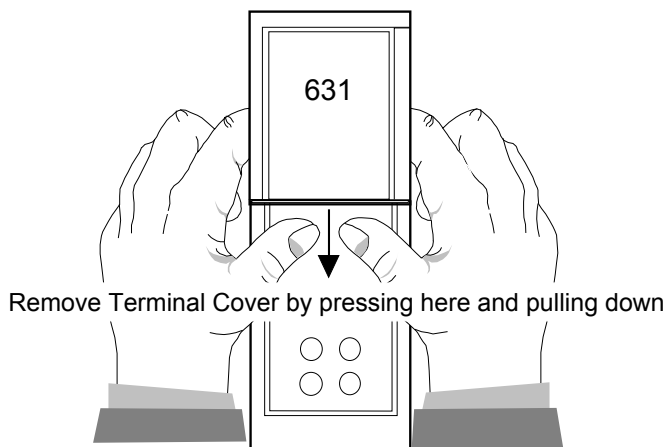

Figure 3-2 Cabling Requirements

Cables are considered to be electrically *sensitive*, *clean* or *noisy*. You should already have planned your cable routes with respect to segregating these cables for EMC compliance. If not, refer to Chapter 12: "Certification for the Servo Drive".



Using Cage Clamp Terminals

Remove the terminal cover as shown above.

Insert a flat-bladed screwdriver (size 3.5 mm max.) inside the smallest hole. Lever the screwdriver, keeping it firmly pressed into the hole. The cage will open.

Insert the stripped wire (5mm to 6mm/0.22in.) or wire crimp inside the cage keeping the screwdriver in position.

Remove the screwdriver. Note the cage provides the correct force for a secure connection.

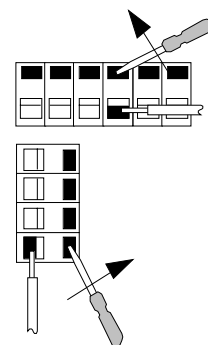

Motor Thermistor

Refer to Chapter 12: “Certification for the Servo Drive” - Solid State Motor Overload Protection.

WARNING!

The servo drive thermistor connections are for SELV only. Eurotherm servo motors series ACM 2n, ACR n and ACG are SELV, other manufacturer’s motors may not be.

If you use a non-Eurotherm servo motor, make sure that the thermistor is insulated to SELV from live parts inside the motor. If not, the thermistor signals have to be wired separately and an additional isolation circuit must be provided before connecting to X30.

Make sure that pins 2 and 6 of X30 are only served by SELV insulated cable leads.

resolver cable (without thermistor connections)

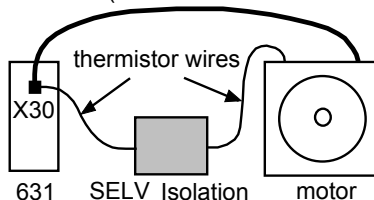

Earth Fault Monitoring Systems

We do not recommend the use of circuit breakers (e.g. RCD, ELCB, GFCI), but where their use is mandatory, they should:

- Operate correctly with dc and ac protective earth currents (i.e. type B RCDs as in Amendment 2 of IEC755).
- Have adjustable trip amplitude and time characteristics to prevent nuisance tripping on switch-on.

3-6 Installing the Servo Drive

When the ac supply is switched on, a pulse of current flows to earth to charge the internal/external ac supply EMC filter's internal capacitors which are connected between phase and earth. This has been minimised in Eurotherm Drives' filters, but may still trip out any circuit breaker in the earth system. In addition, high frequency and dc components of earth leakage currents will flow under normal operating conditions. Under certain fault conditions larger dc protective earth currents may flow. The protective function of some circuit breakers cannot be guaranteed under such operating conditions.

WARNING!

Circuit breakers used with VSDs and other similar equipment are not suitable for personnel protection. Use another means to provide personal safety. Refer to EN50178 (1998) / VDE0160 (1994) / EN60204-1 (1994)

Wiring the Servo Drive

Earth Connections

WARNING!

Due to the working principle of servo drives or filters, there will be an earth leakage current exceeding 10mA dc, 3.5mA ac.

IMPORTANT: Refer to "Earth Fault Monitoring Systems". page 3-5.

The wiring terminals accept a maximum conductor size of 12 AWG (3.2mm²).

The servo drive, when fitted with an internal ac supply EMC filter, is only suitable for earth referenced supplies (TN).

Refer to Chapter 12: "Certification for the Servo Drive" for information on earthing requirements.

DBR1 & DBR2 - External Brake Resistor

Refer to Chapter 13: "Application Notes" - Dynamic Braking for selection details and Chapter 11: "Technical Specifications" - Power Details.

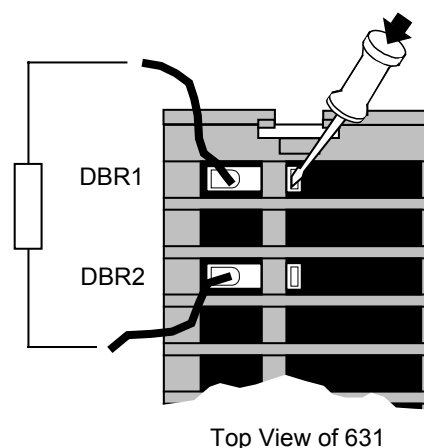

Figure 3-3 External Brake Resistor Terminals

Caution

The resistor should be mounted on a heatsink (back panel) and covered to prevent injury from burning.

X1 - Motor and Power Wiring Connections

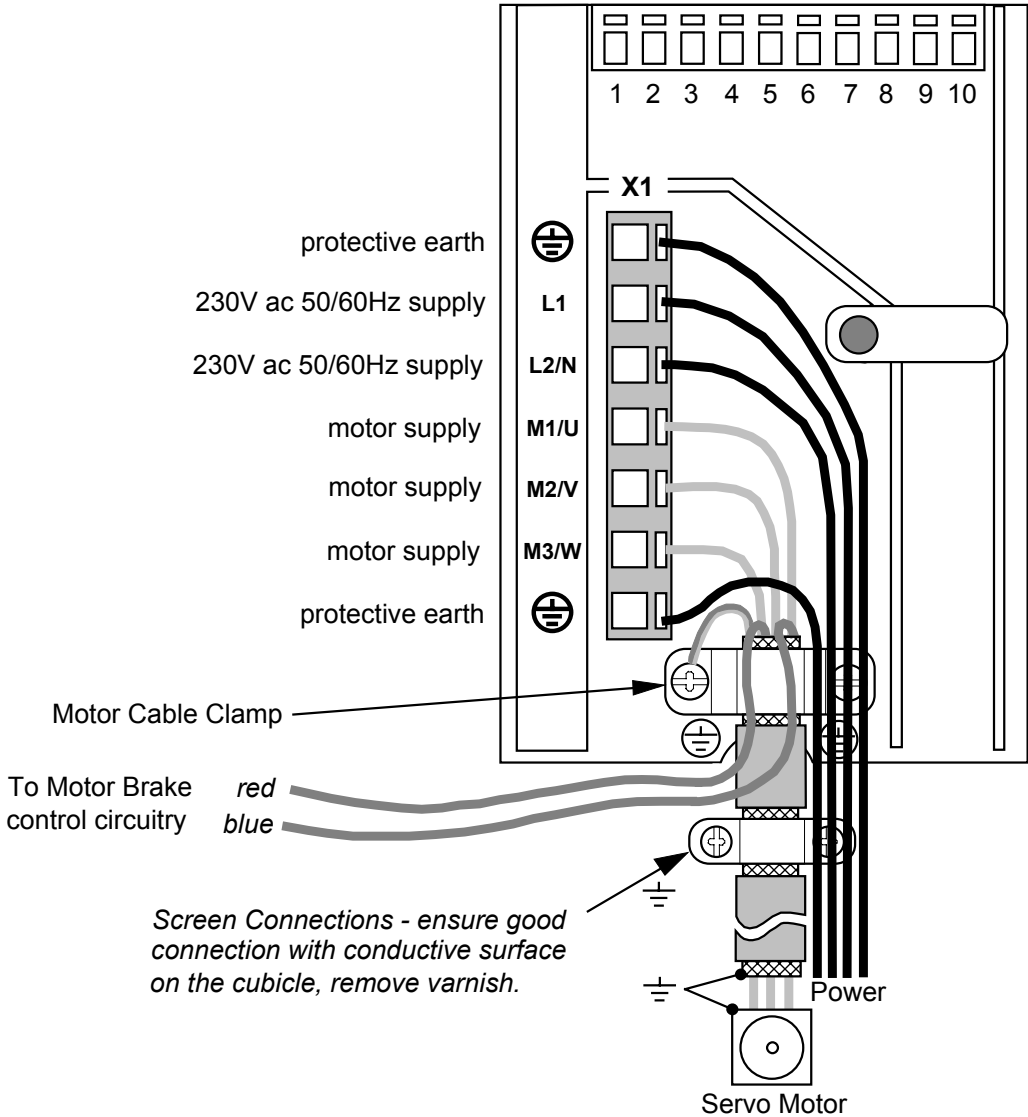

Figure 3-4 631 Power and Earth Wiring Connections

Note: The unit must be permanently earthed using two independent earth conductors using X1. Protect the incoming mains supply using a suitable fuse or circuit breaker as shown in Chapter 11: “Technical Specifications” - Power Details.

Motor Cable Clamp

In order to conform with the specified generic EMC standards, the motor cable must be screened and the screen connected to both the motor frame and the motor cable clamp. This clamp is internally connected to power terminals PE (Protective Earth) and provides convenient 360° connection. It is used for the motor protective earth, motor and control cable screen connections.

Refer to Chapter 12: “Certification for the Servo Drive” for information on meeting generic EMC standards and minimising electrical interference.

3-8 Installing the Servo Drive

X10 - Control Wiring Connections

Functional Earth connected to cubicle backplate providing clean earth for electronic ground and screens

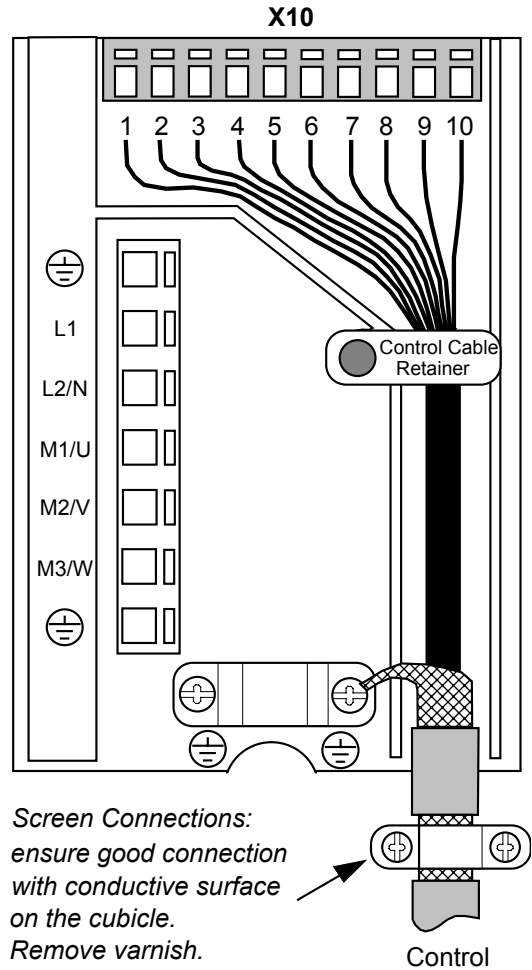
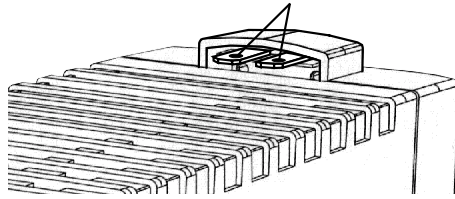

Figure 3-5 631 Control Wiring Connections

Pin	Type	Function
1	±10V, Ri - 10kΩ	ANALOG IN, differential to pin 2 referenced to GND
2	±10V, Ri - 10kΩ	ANALOG IN, differential to pin 1 referenced to GND
3	0V PLC	External supply for digital i/o, related to pin 4
4	24V DC PLC	External supply for digital i/o, related to pin 3
5	Opto-OUT	Configurable (s. 3.1.1)
6	Opto-OUT	Configurable (s. 3.1.1)
7	Opto-IN	ACTIVE, non-configurable activates motor power when high
8	Opto-IN	Configurable (s. 3.1.1)
9	Opto-IN	Configurable (s. 3.1.1)
10	Opto-IN	Configurable (s. 3.1.1)

Note: Use screened control cables to comply with EMC requirements.

All control and signal terminals are SELV, i.e., protected by double/re-inforced insulation. Ensure all wiring is rated for the highest system voltage. Control wiring of between 0.08 mm² (28 AWG) - 2.5 mm² (14 AWG) can be used.

Control Cable Retainer

This clip is used to provide guaranteed segregation of the control and power cables. It may be rotated in either direction to allow easy installation of the control cables.

Refer to Chapter 11: “Technical Specifications” for Control Terminal information.

Refer to Chapter 12: “Certification for the Servo Drive” for information on meeting generic EMC standards and minimising electrical interference.

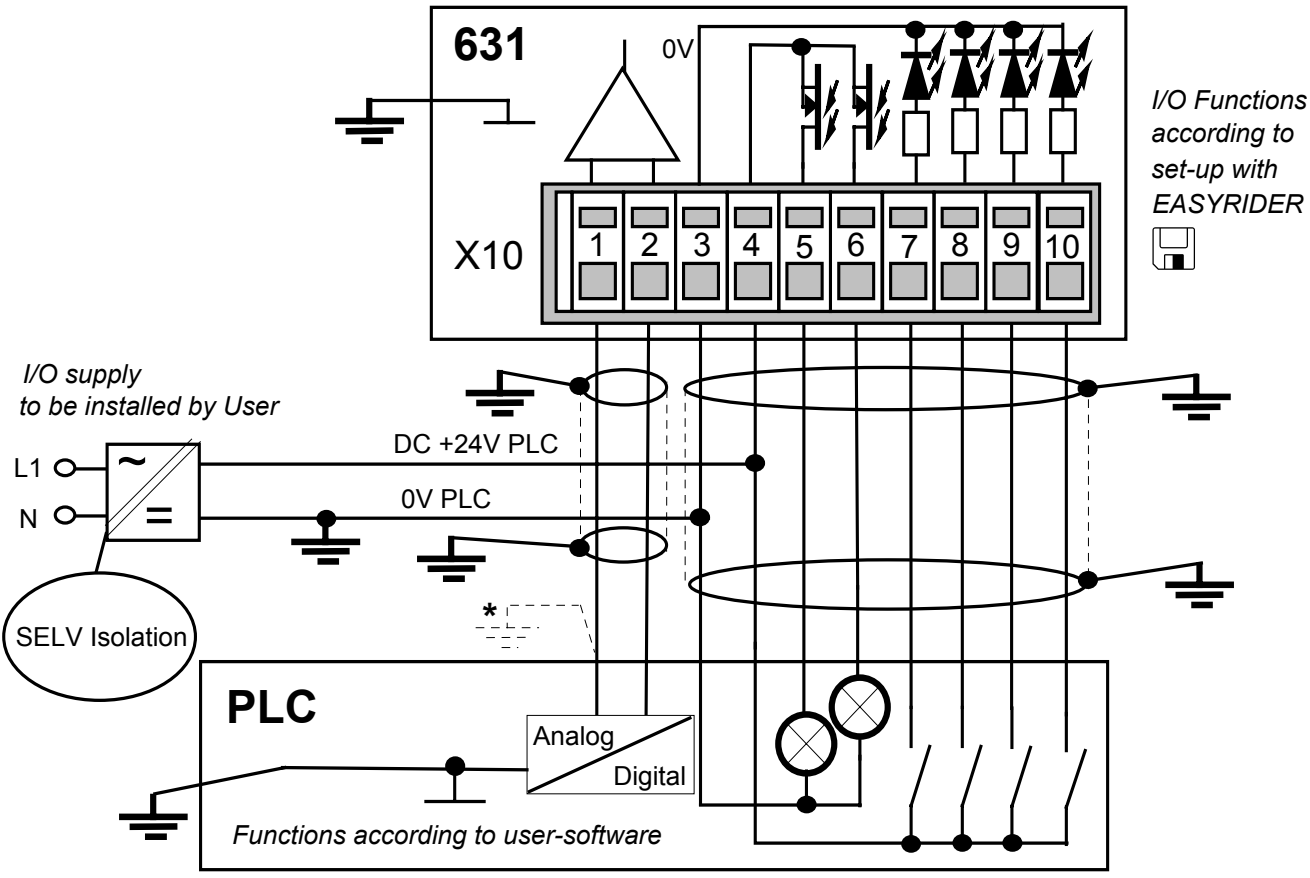

* Analog Output. Polarity according to requirement. Setpoint output and input are working related to earth. It may be useful to connect one pole directly to earth, refer to PLC information.

Figure 3-6 Typical Connection to the Control Terminals (X10)

3-10 Installing the Servo Drive

X30 - Resolver Connection

IMPORTANT: Refer to the WARNING on page 3-5.

The resolver provides a digital value for the rotor position to within one revolution, evaluation: 12 or 14 bit. It is adjustable in the Configuration Menu in the EASYRIDER software.

- commutation according to pole pair number
- actual speed value
- incremental position output
- position value for position regulation

The supplied resolver cable is plugged in to the front of the 631 (socket X30), and into the socket on the Eurotherm approved servo motor. This connection must be made for the 631 to control the operation of the motor. The cable contains wiring for the resolver and the motor thermistor.

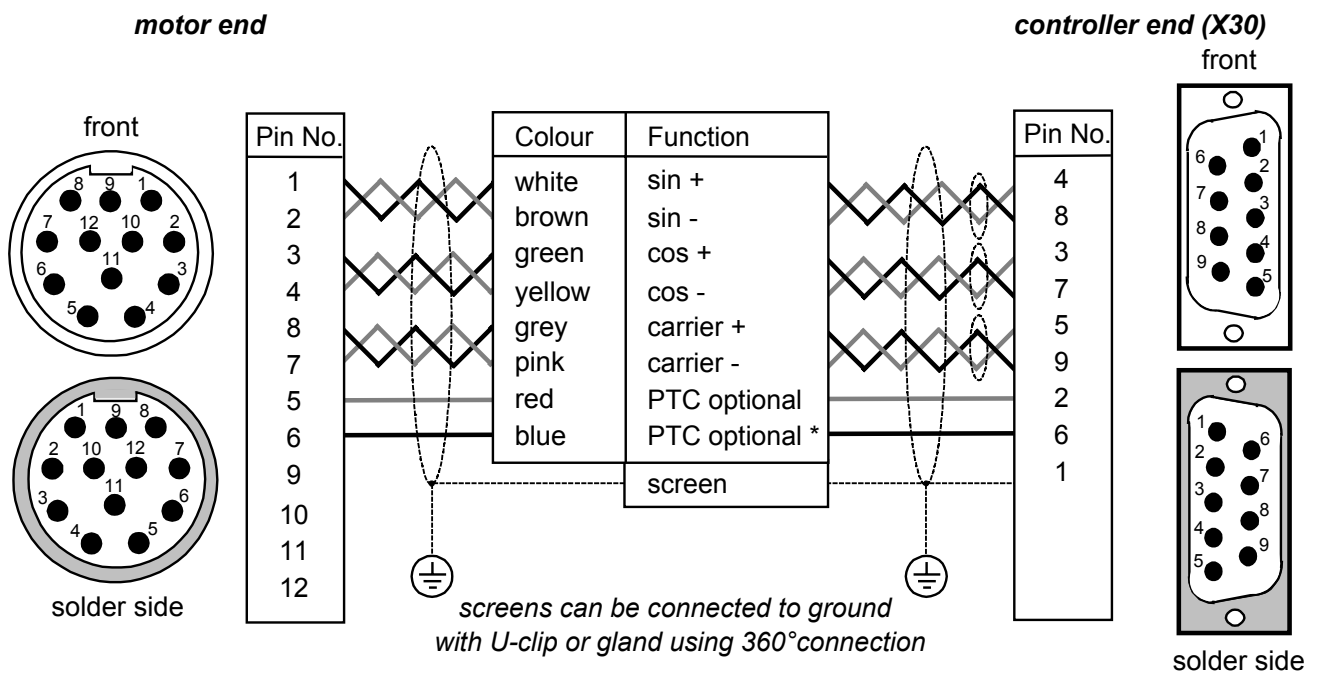

Figure 3-7 Resolver Connections (as supplied cable model KIR)

Note: The plug type shown above is for use with Eurotherm motor types AC Mn only.

Refer to the Warning on page 3-5.

X40/X41 - Multi-function Input/Output Connections

This connection provides encoder emulation, encoder input and stepper motor interface.

Note: Refer to Chapter 11: "Technical Specifications" - X40/X41 - Multi-function Input/Output.

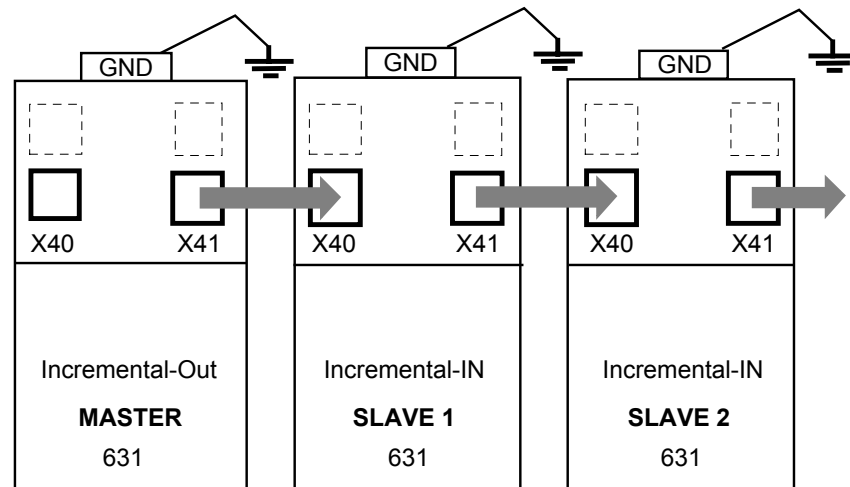

*mount units side-by-side if possible
keep cables as short as possible
X40/X41 signals are referred to PE*

Figure 3-8 Application Example

To synchronise several 631 servo drives, connect the X40/X41 sockets as shown using the specified cables. The 631 is configured using EASYRIDER software .

The X40/X41 input/output functions are configurable using the EASYRIDER  software.
Functions:

- Mode 0 Incremental Output**
- Mode 1 Incremental Input**
- Mode 2 Step Control Pulse/Direction**
- Mode 3 Step Control Pulse (+) (-)**

3-12 Installing the Servo Drive

X40/41 Mode 0 - Incremental Output

- Incremental encoder simulation for processing in positioning modules
- Standard: 1024 increments; other selectable pulse numbers are 512, 256, 128

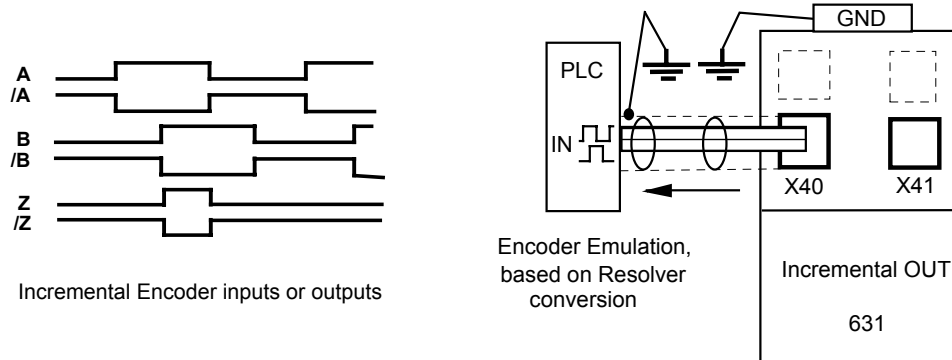

X40	Pin	Function	X41
8-pole Modular Jack, screened 		EASYRIDER X40 mode = 0 X40 and X41 are identical and internally switched in parallel. (X40 = X41) therefore wiring is very easy.	8-pole Modular Jack, screened
		internal connection to GND	Case: Screened
	1	GND	
	2	inverted 0-Index	OUT /Z
	3	0-Index	OUT Z
	4	Channel B inverted	OUT /B
	5	Channel B	OUT B
	6	Channel A inverted	OUT /A
	7	Channel A	OUT A
	8	Output supply voltage 5.5V dc max. 150mA	5VI

Design Rule

The capability of input frequency of any connected device must at least meet the selected value of pulse outputs (increments) on X40.

n = maximum speed (rpm)

x = increments e.g. 1024

f = output frequency at X40/41 4,5,6,7

$$\text{Formula: } f = \frac{n * x}{50} = [\text{Hz}]$$

$$\text{Example: } n = 4000 \text{ rpm} \quad f = \frac{4000 * 1024}{50} = 81920 \text{ Hz}$$

X40/41 Mode 1- Incremental Input

Parameter area of the input signals is 10 - 1,000,000 increments

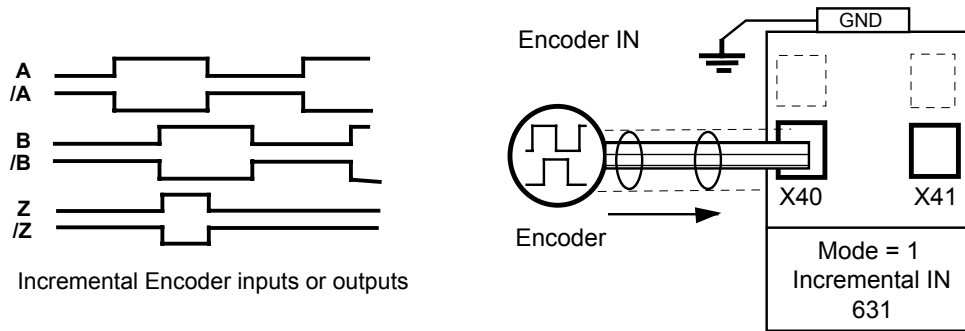

X40	Pin	Function	X41
8-pole Modular Jack, screened 		EASYRIDER X40 mode = 1 X40 and X41 are identical and internally switched in parallel. (X40 = X41) therefore wiring is very easy.	8-pole Modular Jack, screened
		internal connection to GND	Case: Screened
	1	GND	
	2	inverted 0-Index	OUT /Z
	3	0-Index	OUT Z
	4	Channel B inverted	OUT /B
	5	Channel B	OUT B
	6	Channel A inverted	OUT /A
	7	Channel A	OUT A
	8	Output supply voltage 5.5V dc max. 150mA	5VI

Note: The operation of incremental encoders when using long cables may cause a voltage drop of the encoder power supply. We suggest using an external supply if necessary.

3-14 Installing the Servo Drive

X40/41 Mode 2 - Step-Control Pulse/Direction

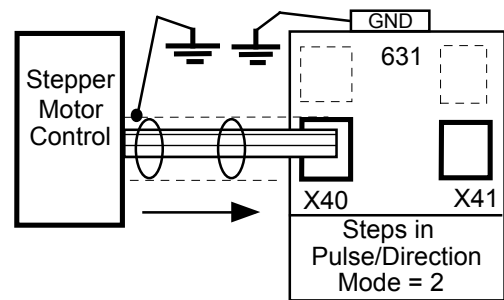
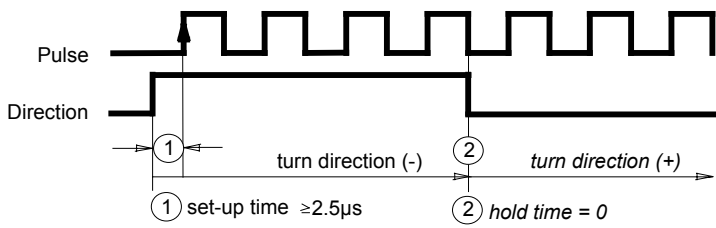

X40	Pin	Function	X41
8-pole Modular Jack, screened 		EASYRIDER X40 mode = 2 X40 and X41 are identical and internally switched in parallel. (X40 = X41) therefore wiring is very easy.	8-pole Modular Jack, screened
		internal connection to GND	Case: Screened
	1	GND	
	2	Direction inverted	IN /R
	3	Direction	IN R
	4	Drive Active	Out Ready
	5	Drive Active inverted	Out /Ready
	6	Pulse	IN P
	7	Pulse Inverted	IN /P
	8	Output supply voltage 5.5V dc max. 150mA	5VI

X40/41 Mode 3 - Step-Control Pulse (+)(-)

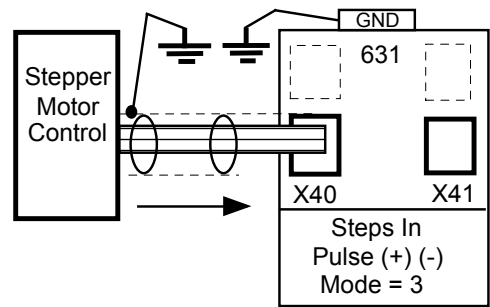
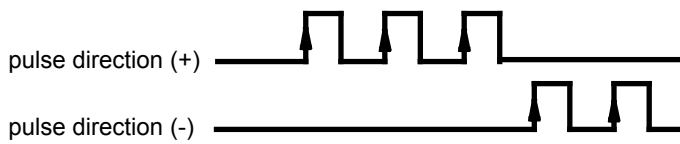



X40	Pin	Function	X41
8-pole Modular Jack, screened 		EASYRIDER X40 mode = 3 X40 and X41 are identical and internally switched in parallel. (X40 = X41) therefore wiring is very easy.	8-pole Modular Jack, screened
		internal connection to GND	Case: Screened
	1	GND	
	2	Pulse (+) Inverted	IN /P+
	3	Pulse (+)	IN P+
	4	Drive Active	Out Ready
	5	Drive Active inverted	Out /Ready
	6	Pulse (-)	IN P-
	7	Pulse (-) inverted	IN /P-
	8	Output supply voltage 5.5V dc max. 150mA	5VI

3-16 Installing the Servo Drive

X20/21 - CAN-Bus Digital Interface Connections

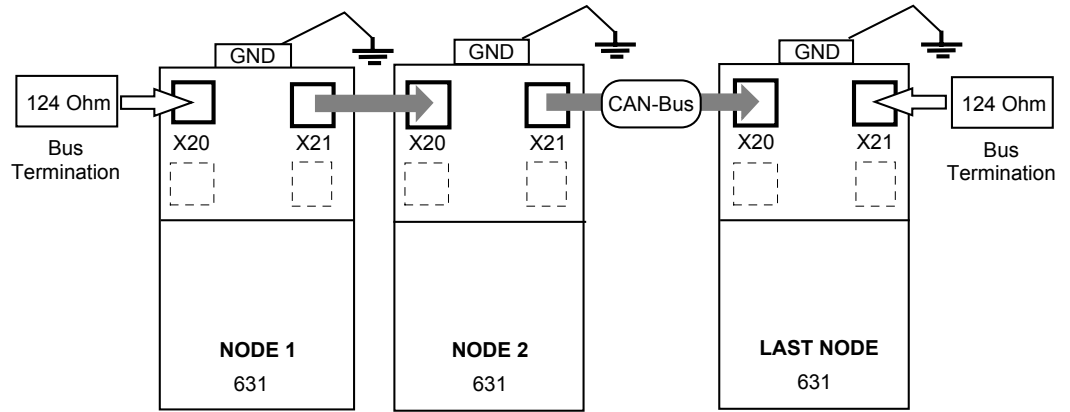
Standard fieldbus protocol CAN-Bus interface.



To network several 631 servo drives, connect the X20/21 sockets as shown using the specified cables. The 631 is configured using EASYRIDER software .

Note: The daisy-chain wiring is intended to be used for local bus distribution. Long bus extensions should not cross daisy-chain sections.

Refer to Chapter 11: “Control and Communications” for cabling details.

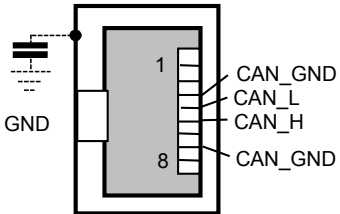
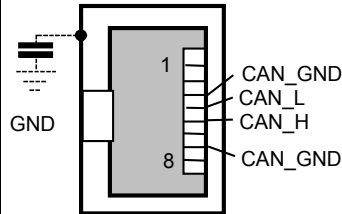
X20	Pin	Function	X21
8-pole Modular Jack, screened 		X20 and X21 are identically and internal switched in parallel with all pins, (X20 = X21) therefore bus-wiring is very easy.	8-pole Modular Jack, screened 
		internal connection to GND via capacitor	Case: Screened
		Operating Conditions and Protocol	See documentation 7.5.3.x
	1		
	2		
	3	CAN_GND reference galvanically separated. Coupling-resistor to PE / GND: 1MΩ	
	4	CAN_L (dominant low)	
	5	CAN_H (dominant high)	
	6		
	7	CAN_GND, like Pin 3	
	8		

This Pin Assignment is related to “CiA Draft Recommendation DR-303, V0.1 / 26.10.98”. The wires on Pins 3/6 and 4/5 should be twisted pairs.

A defined quiescence level on the bus must be guaranteed for communication. You should use terminal resistors on both ends of the line. Use special bus plugs that have a resistance of approximately 124Ω between CAN_L and CAN_H.

Note: A plug with an internal terminal resistor is available see Chapter 9: “Accessories”.

OPERATING MODES

Control Philosophy

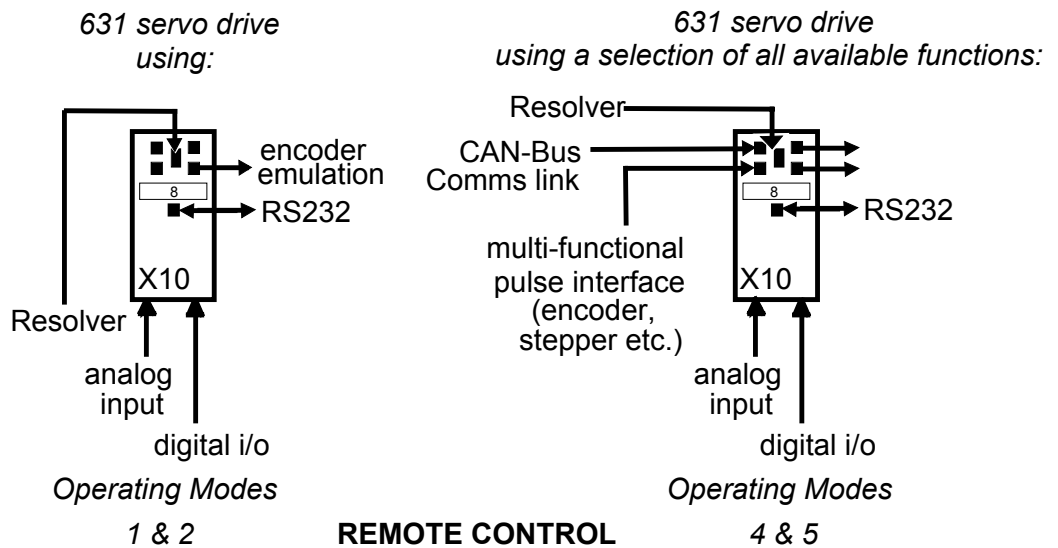



Figure 4-1 Remote Control

Operating Modes

The Operating Mode for the unit is selected using the EASYRIDER software menu: “Commissioning/General”.

The 631 unit does not use Modes 0 and 3. If you attempt to select these, the unit will default to the set-up for Mode 1 - speed control.

Mode No.	Operating Mode	Setpoint Source	BIAS
0	Reserved (as Mode 1)		
1	speed control	analog Input	no
2	current control	analog Input	no
3	Reserved (as Mode 1)		
4	position control using Position Blocks	selectable source using EASYRIDER  (analog or digital)	no
5	position control using BIAS Program	selectable source using EASYRIDER  (analog or digital)	yes

Note: In Operating Mode 5, you can download example BIAS programs from a library, or using the BIAS Editor in EASYRIDER you can create your own programs.

4-2 Operating Modes

Configuring the OPTO Inputs and Outputs (X10)

The OPTO Input and Output functions must be configured for use with each Operating Mode.

The Input/Output functions for terminals X10.5, X10.6, X10.8, X10.9 and X10.10 are selected in the menu: "Commissioning/Input -Output".

The function of each input/output is determined by selecting a number from 0 to 5. The tables below show the possible selections to be used with each Operating Mode.

MODE 1 - SPEED CONTROL (X10.1 and X10.2 are evaluated as the speed setpoint)		
X10 Terminal No.	EASYRIDER Function No.	Description
<i>OPTO outputs</i>		
5	0 4	DRIVE READY (1 = drive can be executed) ACTIVE OK (1 = power stage activated)
6	-	-
<i>OPTO inputs</i>		
7	Fixed input	ACTIVE - activates motor power when high against X10.4
8	4	LIMIT SWITCH +
9	4	LIMIT SWITCH -
10	-	-

MODE 2 - CURRENT CONTROL (X10.1 and X10.2 are evaluated as the current setpoint)		
X10 Terminal No.	EASYRIDER Function No.	Description
<i>OPTO outputs</i>		
5	0 4	DRIVE READY (1 = drive can be executed) ACTIVE OK (1 = power stage activated)
6	-	-
<i>OPTO inputs</i>		
7	Fixed input	ACTIVE - activates motor power when high against X10.4
8	4	LIMIT SWITCH +
9	4	LIMIT SWITCH -
10	-	-

MODE 4 - POSITION CONTROL (POSITION BLOCKS)		
X10 Terminal No.	EASYRIDER Function No.	Description
<i>OPTO outputs</i>		
5	0	DRIVE READY (1 = drive can be executed)
	1	INITIALISED (1 = move reference executed)
	3	TRAIL CONTROL (1 = position within trail window)
	4	ACTIVE OK (1 = power stage activated)
6	0	POSITION REACHED (1 = position within position window)
	1	INITIALISED (1 = move reference executed)
	3	TRAIL CONTROL (1 = position within trail window)
	4	TARGET POSITION REACHED (1 = target position reached)
<i>OPTO inputs</i>		
7	Fixed input	ACTIVE - activates motor power when high against X10.4
8	1	REFERENCE SENSOR
	2	STROBE INPUT (slope 0 - >1) for the BIAS block
	4	LIMIT SWITCH +
9	1	REFERENCE SENSOR
	2	BIAS block selection data 2 ⁰
	3	START (slope 0 - >1) for BIAS move commands
	4	LIMIT SWITCH -
10	1	REFERENCE SENSOR
	2	BIAS block selection data 2 ¹

4-4 Operating Modes

MODE 5 - POSITION CONTROL (BIAS PROGRAM)		
X10 Terminal No.	EASYRIDER Function No.	Description
<i>OPTO outputs</i>		
5	0	DRIVE READY (1 = drive can be executed)
	1	INITIALISED (1 = move reference executed)
	2	BIAS-OUTPUT 5 (set/reset by BIAS program)
	3	TRAIL CONTROL (1 = position within trail window)
	4	ACTIVE OK (1 = power stage activated)
6	0	POSITION REACHED (1 = position within position window)
	1	INITIALISED (1 = move reference executed)
	2	BIAS-OUTPUT 6 (set/reset by BIAS program)
	3	TRAIL CONTROL (1 = position within trail window)
	4	TARGET POSITION REACHED (1 = target position reached)
	5	WARNING
<i>OPTO inputs</i>		
7	Fixed input	ACTIVE - activates motor power when high against X10.4
8	0	BIAS-OUTPUT 8
	1	REFERENCE SENSOR
	2	STROBE INPUT (slope 0 - >1) for the BIAS block
	4	LIMIT SWITCH +
9	0	BIAS-INPUT 9
	1	REFERENCE SENSOR
	2	BIAS block selection data 2 ⁰
	3	START (slope 0 - >1) for BIAS move commands
	4	LIMIT SWITCH -
	5	LATCH INPUT 1
10	0	BIAS-INPUT 10
	1	REFERENCE SENSOR
	2	BIAS block selection data 2 ¹
	5	LATCH INPUT 2

Function Diagrams for Inputs/Outputs

Fault signal / protection function	Protection mode switching off in accordance with EASYRIDER config. menu	Protection mode limiting in accordance with EASYRIDER config. menu
<p>I²t regulator protection</p> <p>output Warning(F5) X10.6</p> <p>output Ready(F0) X10.5</p> <p>Warning display</p> <p>fault signal display</p>	<p>Warning time approx. 3 sec.</p> <p>I-LIMIT</p>	<p>max. current</p> <p>rated current of regulator</p> <p>I-LIMIT</p>
<p>I²t motor protection</p> <p>output Warning(F5) X10.6</p> <p>output Ready(F0) X10.5</p> <p>Warning display</p> <p>fault signal display</p>	<p>Warning time approx. 3 sec.</p> <p>I-LIMIT</p>	<p>max. current</p> <p>rated current of motor</p> <p>I-LIMIT</p>
<p>NTC-motor protection</p> <p>output Warning(F5) X10.6</p> <p>output Ready(F0) X10.5</p> <p>Warning display</p> <p>fault signal display</p>	<p>switch off with R_NTC2</p> <p>I-LIMIT</p>	<p>decrease as of R_NTC1</p> <p>I-LIMIT</p> <p>current limiting</p>
<p>PTC-motor protection</p> <p>output Warning(F5) X10.6</p> <p>output Ready(F0) X10.5</p> <p>Warning display</p> <p>fault signal display</p>	<p>switch off with R_PTC after warning time</p> <p>Warning time approx. 6 sec.</p> <p>I-LIMIT</p>	<div style="border: 1px solid black; padding: 5px; width: fit-content;">no limiting function with PTC</div>
<p>Function Passive -Delay (recommended for motor brake use)</p> <p>input ACTIVE OK (F0) X10.7</p> <p>setpoint internally to zero</p> <p>output stage Active</p> <p>output ACTIVE OK (F4) X10.5 (holding brake)</p> <p>Nsol Nsetpoint</p> <p>reaction time for brake</p>		

Motor Overload Protection

This may be detected in two ways:

Using Temperature Sensors

These are located in the motor windings. Enter the relevant data (type, tripping value) in to the EASYRIDER  menu: COMMISSIONING / MOTOR / TEMPERATURE SENSOR.

Internal Overload Protection

Using thermal simulation of the motor in the drive (I^2t), related to the rated current of the motor. Enter the rated current of the motor into the EASYRIDER  menu: COMMISSIONING / MOTOR / RATED CURRENT MOTOR.

INITIAL SET-UP

Connecting the X15/RS232 EASYRIDER Set-up Service

Connect your PC to the 631 Servo Drive using the supplied RS232 cable. The cable is wired as shown below.

Refer to Chapter 9: “Accessories”.

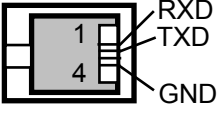
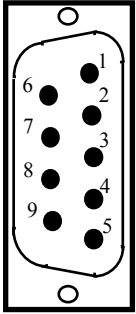
X15 RS232	Pin	Function	for PC RS232	
4-pole Modular Jack 			Female (viewed on solder side)	
RXD	1	Receive serial data	3	RXD
TXD	2	Transmit serial data	2	TXD
	3	<i>do not connect</i>		
GND	4	GND	5	GND

IMPORTANT: The X15 interface is not opto-isolated. Connection and disconnection of the communication cable is only allowed if there is no communication, i.e. PC EASYRIDER  on main screen or off-line.

The line-connection of the PC must be close to the servo drive to achieve operation related to a common reference (common ground).

Make sure that the Functional Earth terminal on the top of the drive is connected to earth.

Pre-Operation Checks

WARNING!

Wait for 5 minutes after disconnecting power before working on any part of the system or removing the terminal cover from the Servo Drive.

Initial checks before applying power:

- Mains power supply voltage is correct.
- Motor is of correct voltage rating and is connected with the correct polarity.
- Check all external wiring circuits - power, control, resolver, motor and earth connections.

Note: *Completely disconnect the Servo Drive before point to point checking with a buzzer, or when checking insulation with a Meggar.*

- Check for damage to equipment.
- Check for loose ends, clippings, drilling swarf etc. lodged in the Servo Drive and system.
- If possible check that the motor can be turned freely, and that any cooling fans are intact and free from obstruction.

Ensure the safety of the complete system before the Servo Drive is energised:

- Ensure that rotation of the motor in either direction will not cause damage.
- Ensure that nobody else is working on another part of the system which will be affected by powering up.
- Ensure that other equipment will not be adversely affected by powering up.

Prepare to energise the Servo Drive and system as follows:

- Remove the supply fuses, or isolate using the supply circuit breaker.
- Disconnect the load from the motor shaft, if possible.
- Check external run contacts are open.
- Check external speed setpoints are all zero.

Initial Set-up with EASYRIDER

Note: Refer to your EASYRIDER software HELP menu. This chapter presumes you now have some experience of the EASYRIDER software. If not, we suggest you practice in Simulation Mode within EASYRIDER.

Access to several software functions is password restricted. Commissioning should be carried out by competent personnel only.

IMPORTANT: During commissioning, the motor shaft WILL rotate!

Commissioning Instructions

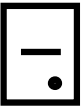
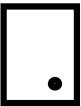
Step	Action	Remark
Initial Set-up		
1	<ul style="list-style-type: none"> Observe all the Pre-Operation Checks. The drive should be fully and correctly wired. Connect the PC by RS232 link to the drive service port X15 and start EASYRIDER. Set OPTO Input 7 to be NOT ACTIVE, i.e. X10.7 is tied low against X10.3 Switch on the supply voltage, AC 230V. Check for EASYRIDER communication by seeing if the diagnostic menu is active. The correct display is shown opposite, i.e. regulator ready, not active. 	
2	Do you already have an existing Parameter File to load? YES Load your parameter file, xxx.631. Restore parameters to the drive. If available, load the appropriate BIAS-file, xxx.ASB from the menu BIAS/EDITOR/FILE/LOAD BIAS PROGRAM. Go to Step 4 or 5 (experts)	NO From the menu FILE/LOAD PARAMETERS select and load the file called DEFAULT.631 Continue with Step 3
Motor Selection		
3	From the menu COMMISSIONING/MOTOR adjust the maximum current to be the nominal motor current rating, or smaller. Select the motor you intend to use from either the Default Motor Library or Customer Motor Library. As you leave this menu you will be asked to accept the changes. You are then asked to store the new data to power-down memory in the drive.	
Tuning the Speed Loop		
4	Go to the menu TUNING/SPEED LOOP TUNING For safety, set the analog setpoint input (X10.1/X10.2) to 0V. Set OPTO Input 7 to be ACTIVE, i.e. X10.7 is tied high against X10.4 Caution: The motor may rotate.	
	Adjust the test generator initially to safe "Set Speed" and "Duration" values. Activate the test generator with "START Motor" with "S=Start". Optimise P and I gain manually. Aim to achieve the typical graph shown opposite. Is the result ok? YES As you leave this menu you will be asked to store the new data to power-down memory in the drive and to de-activate the drive. Continue with Step 5	NO Go to Step U1

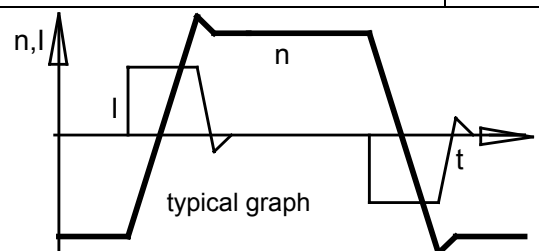

5-4 Initial Set-up

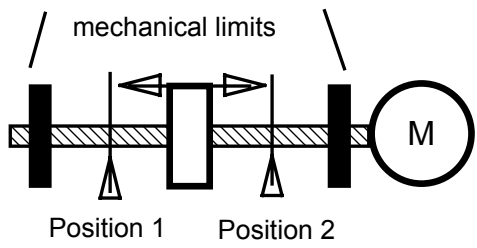
Step	Action	Remark
Tuning the Position Loop		
5	<p>Switch the power OFF and de-couple</p> <p>The first setup of the positioning loop should be executed with no load. (When the tuning is finished, the mechanics can be re-connected).</p> <p>Move the application to a safe position within the mechanical limits.</p> <p>Switch the power ON</p> <p>Make sure you know how to stop the motor if necessary before performing the following:</p> <p>Go to the menu TUNING/POSITION LOOP TUNING.</p> <p>Adjust the test generator initially to safe "Velocity", "Acceleration", and "Deceleration" values.</p> <p>Select slow speed and slow acceleration/deceleration first to increase later.</p> <p>Select safe values for "Position 1" and "Position 2".</p> <p>Every activation of "START Motor" produces a motion from Position 1 to Position 2, and vice versa with the next activation. Select "START Motor".</p> <p>Observe the behaviour of the application and graph and optimise the tuning parameters (P, I and V gain).</p> <p>Is the result ok?</p>	
	<p>YES</p> <p>Basic power-up is now complete</p> <p>Further functions (selecting the Operating Mode, Configuring of I/Os, CAN-Bus functions, synchronising etc.) may now be completed.</p>	<p>NO</p> <p>Go back to Step 4</p>
Save your Set-up		
Select the menu FILE / STORE PARAMETERS and store the data using the F7 key.		

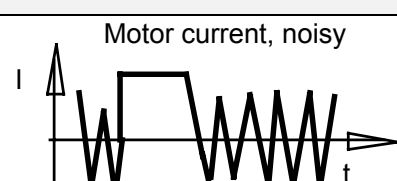
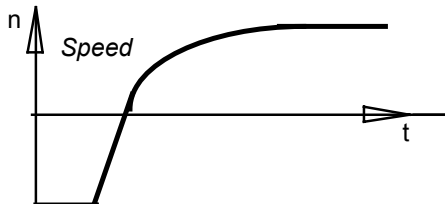
Tuning the Speed Loop		
U1	<p>Go to the menu TUNING/SPEED LOOP TUNING.</p> <p>Stable parameters are calculated based on the system data and can be called-up using the F5 key. Manual tuning may be necessary.</p> <p>Rated values can be sourced either digitally by the internal generator or analog by using $\pm 10V$ at X10.1 and X10.2.</p> <p>The addition of both sources will be active.</p> <p>Note: <i>Tuning too hard will cause current ripple, high power-dissipation and acoustic motor noise.</i></p> <p>Too weak adjustment causes slow loop reactions, that may cause problems for the tuning of position loops.</p> <p>Is the result ok?</p>	 <p>P Gain too high, or I-time constant too small</p>  <p>P Gain too small or I-time constant too high</p>
	<p>YES</p> <p>Go back to Step 4</p>	<p>NO</p> <p>Continue with U2</p>

Tuning the Current Loop**IMPORTANT:** Only undertake tuning the current loop after consulting with Eurotherm engineers.

U2	Stable parameters are calculated based on the system data and can be called up using the F5 key. Manual tuning may be necessary. Rated values can be sourced either digitally by the internal generator or analog by using $\pm 10V$ at X10.1 and X10.2. The addition of both sources will be active Go back to Step 4
-----------	--

PROGRAMMING YOUR APPLICATION

EASYRIDER Software

The EASYRIDER software tool is provided to fine-tune the 631 servo drive to the motor, and program the servo drive for operation using either “Position Blocks” or the BIAS programming language.

Install the software which is available as a DOS version, or suitable for use as a Windows application. You can either connect the drive to your PC or you can have the software simulate a drive. We suggest you practice using a simulation before attempting a set-up for the first time.

When running the software you should be aware of the following:

- The software is password protected. It will initialise with an authorisation of Level 0 (if an incorrect password is entered it will default to Level 0). At this level you can view the software without making permanent changes. To configure the drive, you must enter EASY when asked for the password by Autopilot. This will increase the authorisation to Level 1 allowing you to write permanent changes to the drive. (You can also enter this in the menu: “Options/Password”).
- There are several demonstrations loaded with the software. To simulate communication with the 631 product you may need to set this under the following menu: “Options/General Options/Simulated Drive Type”. This selection is saved when you exit the software.
- You must supply an external 24V supply for terminal X10.7 (ACTIVE/NOT ACTIVE) in order to operate the drive.
- The software checks for the correct connections to the drive, i.e. resolver, when not simulating and may not let you proceed with the configuration. Ensure the 631 is fully and correctly wired.

WARNING!

The EASYRIDER set-up procedure will rotate the motor shaft.

Help

A context-sensitive On-line Help menu is available by pressing the F1 key.

Pressing F9 from any screen displays the Amplifier Diagnosis page from the “Diagnosis” menu which also contains other helpful pages for fault finding.

Autopilot

Starting the EASYRIDER software displays an option window for running the Autopilot ‘wizard’. This is used for initially setting-up the drive and will help you to do the following:

Select the COM port

Select the motor type from a default library, or create your own library

EASYRIDER automatically saves the settings to the drive

Optimise the Speed Loop

optimise the Position Loop

Select the Operating Mode from the General Configuration page (defaults to Speed Control)

Select the correct Input/Output functions

Set-up the Counter Configuration page

Set-up the Supervision Configuration page

6-2 Programming Your Application

Set-up any other information necessary to your Operating Mode

Select to save your changes to the drive

Included with these pages are instructions on wiring, safety etc. The Speed Loop and Position Loop Optimization pages will already contain sensible values (loaded from your motor selection) and should require only fine tuning to your system.

*Having chosen an Operating Mode, you then make **relevant** selections in the Input/Output Configuration page. Press the F1 key for context sensitive help about each input/output.*

The Autopilot instructions recommend that the initial set-up is carried out without load. When the set-up is complete and load is applied, you can optimize the drive's performance in the "Tuning" menu.

Note: *Data edited in the EASYRIDER software is transmitted to servo drive but not saved. Only the command STORE ALL DATA (menu COMMAND/STORE ALL DATA) writes the data into the servo drive's non-volatile memory. Data stored here is saved during power-down.*

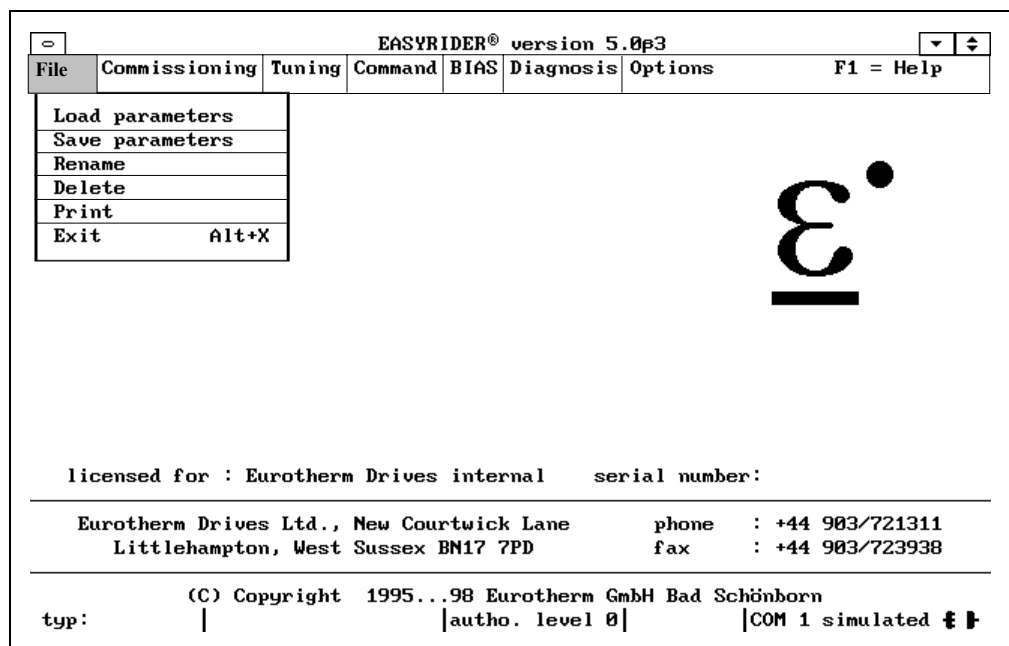

Figure 6-1 EASYRIDER Main Screen

BIAS Programming Language

Select BIAS from the menu in the main screen. You can program the drive to perform a set routine involving up to 1500 lines of code. The BIAS program is used when Operating Mode 5 is selected.

We suggest you practice programming by using and applying the example files (xxx.ASB) supplied with the software.

Note: *The BIAS program can provide a PLC function in Operating Mode 5. This removes the requirement for an external PLC. This is started using the BIAS Execution Pointer command.*

The BIAS program contains the following command groups:

- Organisation commands
 - fixing start and end of the main programs and sub-routines
 - conditional and unconditional jump commands
- Commands relevant to motion
- Set/delete commands for outputs and flags
- Commands for variables

For more information refer to the BIAS Programming Language manual (UL,10,6,5).

EASYSRIDER Main Screen - Menu Options

file	commissioning	tuning	command	BIAS	diagnosis	options
load parameter	general	autopilot	deactivate drive	Editor	amplifier diagnosis	simulate communication
save parameter	in-/ output	current loop	activate drive		in-/ output diagnosis	select interface
print parameter	motor	speed loop	reset drive fault		BIAS diagnosis	deutsch / français
	counter	position loop	PC-login		oscilloscope	test serial interface
exit	supervision	analogue in-/ output	PC-logout		field bus diagnosis	general options
	position blocks		store all data			password/ authorisation level
	field bus		select axis number			change password
	special function		serial single command			update firmware

Menu system BIAS-screen

file	edit	program	command	diagnosis	options
new BIAS-program	undo	change edit mode	deactivate drive	amplifier diagnosis	simulate communication
load BIAS-program	redo	BIAS-program definitions	activate drive	in-/ output diagnosis	select interface
save BIAS-program	cut	BIAS-program definition configuration	reset drive fault	BIAS diagnosis	deutsch / français
load BIAS-example	copy	transmit BIAS-program	PC-login	oscilloscope	test serial interface
print BIAS-program	paste	compare BIAS-program	PC-logout	field bus diagnosis	general options
Exit BIAS-Editor	delete	calculate cam-profile	store all data		password/ authorisation level
	search	read BIAS-program	select axis number		change password
	go to		serial single command		update firmware
	insert label				
	ins.comment				

BIAS Commands

0	1	2	3	4	5	6	7	8
move position	move position + parameter	position =	position = [variable X]	[variable X] = position	NOP	flag X =	If input X ?	[variable X] =
move incremental position	move incremental position + parameter	speed =	speed = [variable X]	[variable X] = speed	end of program	If flag X = ?	If output X ?	If [variable X] ? const.
move datum	move datum + parameter	acceleration =	acceleration = [variable X]	[variable X] = acceleration	sub-program	flag X = flag Y	output X =	[variable X] = [variable Y] + const.
move infinite positive	move infinite positive + parameter	deceleration =	deceleration = [variable X]	[variable X] = deceleration	end of sub-program	flag X = input Y	output X = flag Y	[variable X] = [variable Y] - const.
move infinite negative	move infinite negative + parameter	gear factor =	gear factor = [variable X]	[variable X] = gear factor	PLC-program	flag X = output Y		[variable X] = [variable Y] * const.
move synchron	move synchron + parameter	"position reached" window =	"position reached" window = [variable X]	[variable X] = block-number	jump	flag X = flag Y & flag Z		[variable X] = [variable Y] / const.
move cam-profile	move analogue value + integrator	remaining position =	remaining position = [variable X]	[variable X] = actual position Y	jump [variable X]	flag X = flag Y flag Z		[variable X] = flag Y, number Z
synchronous settings 1	move speed + integrator	ramp filter =	maximal current = [variable X]	[variable X] = analogue input Y	BIAS execution pointer	flag X = flag Y ^ flag Z		
synchronous settings 2		actual position X =	actual position X = [variable Y]	[variable X] = latchposition Y	wait for "position reached"			[variable X] = [variable Y]
move PID ; speed		If actual position X ? const.	analogue output = [variable X] (*)	[variable X] = actual speed Y	wait time			If [variable X] ? [variable Y]
move PID ; torque	cycle length =	If actual position X ? [var. Y]	PID scaling	[variable X] = latchstatus Y	wait time [variable X]			[variable X] = [var. Y] + [var. Z]
	cycle length = [variable X]	sensor window	sensor window = [variable X]	[variable X] = position Y	BIAS execution pointer = [var. X]			[variable X] = [var. Y] - [var. Z]
		sensor position	sensor position = [variable X]	[variable X] = value Y				[variable X] = [var. Y] * [var. Z]
		sensor adjustment 1	sensor adjustment 1 = [variable X]					[variable X] = [var. Y] / [variable Z]
		sensor adjustment 2	sensor adjustment 2 = [variable X]					[teachvar. X] = [variable Y]
start axis		update parameter	PID parameter		virtual program			[teachvar. Y] = [variable X]
stop axis	stop axis + parameter							[variable X] = [teachvar. Y]

defined in BIAS-, PLC- and Math.-program

defined in PLC- and Math.-program

BIAS-execution pointer

defined in BIAS- and PLC-program

stop axis

only defined in BIAS-program

start axis

BIAS – Extended Command Overview

9	10	11
mathematics - program	table [variable X] =	[D_variable X] = [D_variable Y] + [D_variable Z]
profil-initialization	table[variable X] = [y variable Z]	[D_variable X] = [D_variable Y] - [D_variable Z]
profil-cycle lenght	[x_variable Y] = table[variable Z]	[D_variable X] = [D_variable Y] * [D_variable Z]
[variable X] = profil value	[w_variable X] = [y variable Z]	[D_variable X] = [D_variable Y] / [D_variable Z]
profil value = [variable X]	[x_variable Y] = const.	If [D_variable X] ? [D_variable Y]
	[variable [X]] = const.	[D_variable X] = SIN [D_variable Y]
	[variable [X]] = [variable Y]	[D_variable X] = COS [D_variable Y]
save table	[variable X] = [variable [Y]]	[D_variable X] = SQRT [D_variable Y]

These commands are only available with firmware version 5.13 onwards.

With older firmware versions this command will cause the error message "invalid BIAS-command".

mathematics-program

defined in BIAS and PLC-program

table [variable X] =

only defined in math.-program

General Keyboard Definitions

- ESC = terminate command
- Alt = activate menu system
- Tab = next parameter
- Shift+Tab = previous parameter

Key	Function	Key	Function
F1	online help	shift+F1	online help
F2		shift+F2	
F3		shift+F3	
F4		shift+F4	
F5		shift+F5	
F6	PC login	shift+F6	PC logout
F7	save all data	shift+F7	
F8	menu dependant function	shift+F8	menu dependant function
F9	diagnosis	shift+F9	oscilloscope
F10	deactivate Servo Drive	shift+F10	activate Servo Drive
F11	select active axis	shift+F11	

BIAS Editor Keyboard Shortcuts

Key	Function
F1	General help screen for the BIAS Editor
Shift+F1	Help with the selected BIAS command
Ctrl+F1	Help with the actual BIAS block in program
F2	Load a BIAS program from disk
F3	Save the BIAS program to disk
F4	Transmit the BIAS program
Alt	Activate the menu line
Tab	Change to the next parameter
Shift + Tab	Change to the previous parameter
Ctrl + I	Changing the insert mode (the active mode is displayed at the bottom of the screen)
Ctrl + L	Inserting a label
Ctrl + K	Inserting a comment line
Ctrl + Cursor	Marking BIAS blocks in the program
Ctrl + Del	Cutting-out marked BIAS blocks
Ctrl + Ins	Copying marked BIAS blocks
Shift + Cursor	Selecting the BIAS command to insert
Shift + Enter	Inserting the selected BIAS command
Shift + Del	Deleting marked BIAS blocks
Shift + Ins	Inserting BIAS blocks which are cut out or copied at the cursor position

DIAGNOSTICS AND FAULT FINDING

The seven-segment display is illuminated when the servo drive is powered-up. It provides information on the state of the drive, active trips, and assists in fault finding.

Remember to remove the protective film covering the display when installing the drive.

Diagnostic Display

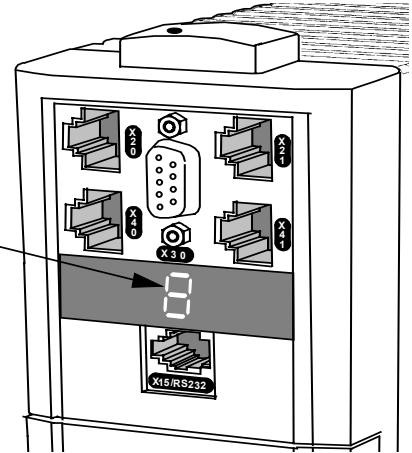



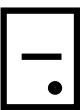
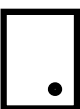



Figure 7-1 Diagnostic Display

Resetting a Trip Condition









There are two options:









1. Switch the supply voltage OFF and ON
2. Use EASYRIDER 

Trip Diagnostics

Display	Explanation	Ready * (output X10.5)	Warning * (output X10.6)	Comment
	no display	off	off	Is the supply voltage present? Are the external fuses ok?
	system ready to operate	on	off	regulator ready not active
	system active			output stage active, no interference
	internal stop deactivation via serial interface	off	off	<ul style="list-style-type: none"> • Re-start the drive or perform a RESET and activate the drive
	Internal stop	-	-	Deactivation via BIAS command
	Active input is activated with switching on	off	off	<ul style="list-style-type: none"> • Switch ACTIVE X10.7 to Low and then to High

7-2 Diagnostics and Fault Finding

Display	Explanation	Ready * (output X10.5)	Warning * (output X10.6)	Comment
	Supply undervoltage <Ua low threshold	off	off	Is the power supply present? Status signal disappears, if DC-bus voltage over the threshold.
	Fault Supply undervoltage <Ua low threshold	off	off	Is the power supply present? Error signal appears, if DC-bus voltage under the Ua low threshold.
	Fault in resolver system	off	off	Is the encoder system supply present? Is the wiring to the encoder system ok? Is the encoder system ok?
	I ² t overload of the drive	-	-	Does the control loop oscillate? P-amplification too high Mechanics stiff? Requirements too high? Is warning /8/ evaluated?
	overload of the motor I ² t	-	-	Does the control loop oscillate? P-amplification too high Mechanics stiff? Requirements too high? Is warning /8/ evaluated?
	overtemperature of the output stage	-	-	Adequate cooling of the regulator? Is the ambient temperature too high?
	overvoltage DC bus	-	-	Ballast module ok? Adequate ballast module?
	Chassis shorting and short circuit due to hardware	off	off	Is the motor cabling ok? Are the digital loops setup ok? Is there a short circuit to chassis in the motor? Is the braking resistor Ohm value too low? <ul style="list-style-type: none"> • Apply a toroidal core or choke in motor-cable. • Try to restart • Return the unit for repair
	WARNING! Overload of the regulator or motor. If no reaction within approximately 3 seconds the unit switches off with signals /3/, /4/ or /5/. Signal /8/ clears when there is no more danger or the unit is switched off	on	*	Mechanics stiff? Defective bearings; Cold grease? <ul style="list-style-type: none"> • Reduce requirements and creep to next possible STOP

Display	Explanation	Ready * (output X10.5)	Warning * (output X10.6)	Comment
	overtemperature motor (NTC/PTC)	off		Check overload of the motor/cooling etc.
	motor temperature warning	on	*	Check overload of the motor/cooling etc.
	ballast active			Brake energy is removed
	warning ballast	on	*	Ballast resistance usage is >90%
	switch off ballast	on	*	Ballast resistance overloaded
	trailing window exceeded			Only in operation mode "position control" <ul style="list-style-type: none"> • optimise parameters • check mechanics
	trailing error with switch off			Only in operation mode "position control" <ul style="list-style-type: none"> • optimise parameters • check mechanics • increase trailing window
	memory checksum error	off	off	<ul style="list-style-type: none"> • Try to restart • Load new parameters
	internal fault	off	off	<ul style="list-style-type: none"> • controller fault Return the unit for repair

** Configuration as stated, refer to Chapter 4: "Operating Modes" - Configuring the OPTO Inputs and Outputs (X10)*

The last error signal will be displayed after restart in EASYRIDER  - Diagnosis:Menu, (History Status Memory, page 7-5).

7-4 Diagnostics and Fault Finding

Fault Finding

The following list refers to faults which can occur during operation.

	Error	Explanation and remedy
*	Motor does not operate despite current flow	Is the motor mechanically blocked? Is the motor brake released?
<input type="checkbox"/>	Motor runs unevenly	Check the setpoint wiring. Check grounding and shielding. Inappropriate speed loop values ? <ul style="list-style-type: none"> Reduce amplification and/or increase time constant (use EASYRIDER)
<input type="checkbox"/>	No reaction on setpoint value although torque in stand still	Limit switch - functions activated ? (BIAS)
<input type="checkbox"/>	No current flow; no torque despite activating the regulator correctly	Motor cables interrupted?
<input type="checkbox"/>	Interference symptoms with power frequency	Ground loops in setpoint or actual value wiring? Shieldings laid on both sides? Signal cables near high voltage cables?
*	Motor takes up preferred positions after activation	Position encoder or motor cables with reversed poles? Resolver or encoder incorrectly adjusted? Number of motor poles set incorrectly? (config. menu)
*	Motor runs up immediately after activation although there is no setpoint	Motor cables or resolver cables reversed? Resolver incorrectly adjusted?
<input type="checkbox"/>	Motor reaches, in idling cycle, a very different speed when running right from running left	Resolver incorrectly adjusted

* Displays /3./ or /4./ for a short time after activating before showing warning /8./

Re-actions of Supply Voltage Supervising Functions

The following diagram refers to the internal dc bus voltage (rectified from an ac voltage). Note that voltage ripple effects have to be taken in to account, refer to Chapter 11: "Technical Specifications" - Derating of Output Voltage.

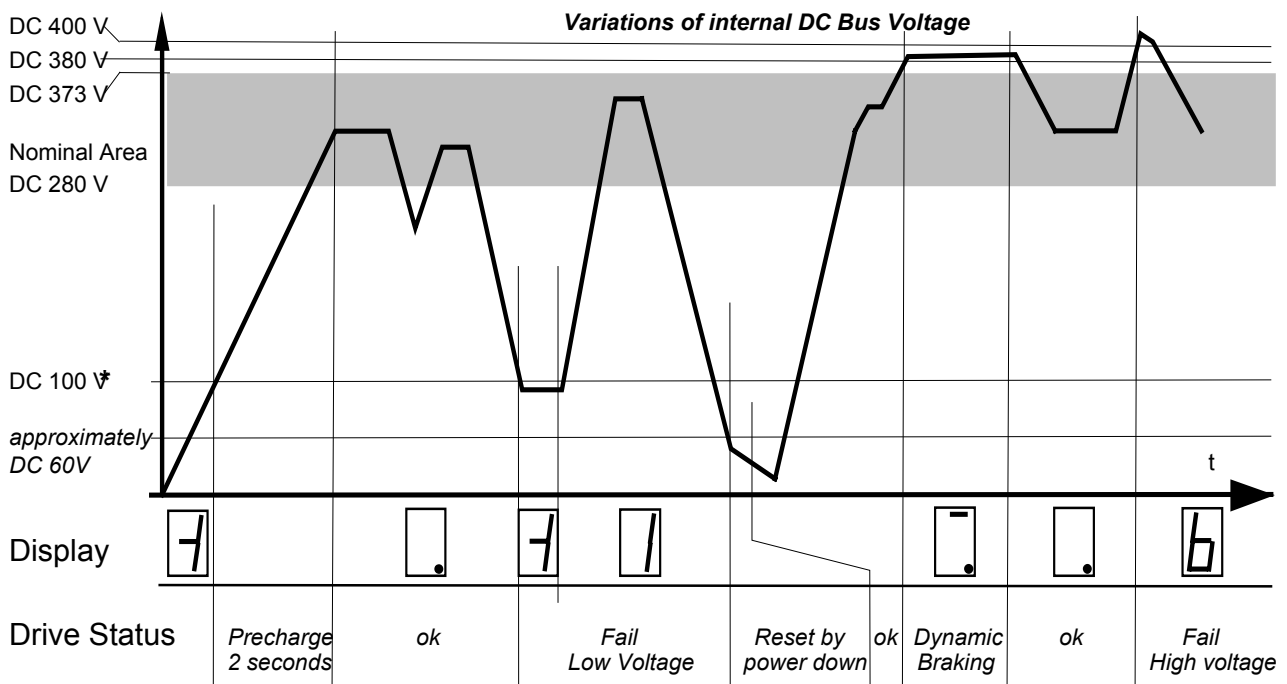

* Default value, may be changed using EASYRIDER

History Status Memory

When the unit is powered down, a set of important indicators is stored in to dedicated memory. This allows the last eight status conditions to displayed by the EASYRIDER  diagnostic menu. Thus important failure information, for instance, is not lost when the unit is powered down.

ROUTINE MAINTENANCE AND REPAIR

Routine Maintenance

Periodically inspect the Servo drive for build-up of dust or obstructions that may affect ventilation of the unit. Remove this using dry air.

Repair

There are no user-serviceable components.

IMPORTANT: MAKE NO ATTEMPT TO REPAIR THE UNIT - RETURN IT TO EUROTHERM DRIVES.

Saving Your Application Data

Although the Servo drive retains saved settings during power-down, it would be wise for you to keep a back-up of your data. You may, depending upon your knowledge of the fault, attempt the back-up of your application data now.

Returning the Unit to Eurotherm Drives

Please have the following information available:

- The model and serial number - see the unit's rating label
- Details of the fault

Contact your nearest Eurotherm Drives Service Centre to arrange return of the item.

You will be given a *Returned Material Authorisation*. Use this as a reference on all paperwork you return with the faulty item. Pack and despatch the item in the original packing materials; or at least an anti-static enclosure. Do not allow packaging chips to enter the unit.

Disposal

The digital servo drive consists of different materials.

The following table shows, which materials can be recycled and which have to be disposed of in a special way.

Material	Recycle	Disposal
metal	yes	no
plastics material	yes	no
printed board assembly	no	yes

IMPORTANT: Dispose of the appropriate materials in accordance with the valid environmental control laws.

ACCESSORIES

Note: Other cable lengths are available, contact Eurotherm Drives for details.

Products	Order Number	Illustration
Motor Cable For ACG motors only <i>Low-cost cable for fixed installations only - without Holding Brake wires</i>	UK: CM469021U020 Germany: MK.1042.0020	
Motor Cable For ACG, AC M2n and AC Rn motors <i>Flexible cable - with holding brake wires</i>	UK: CM469023U020 Germany: MK.6400.0020	
Resolver Cable For ACG, AC M2n and AC Rn motors (X30) <i>Low-cost cable for fixed installations only</i>	UK: CM469025U020 Germany: RK.631030020	Sub-miniature D, 9 way
Resolver Cable For ACG, AC M2n and AC Rn motors (X30) <i>Flexible cable</i>	UK: CM469027U020 Germany: RK.6300.0020	Sub-miniature D, 9 way
RS232 Service Connector Cable X15 (631 to PC)	UK: LA387599 Germany: KK.5004.0003	RJ11 Plug Sub-miniature D, 9 way female
Jumper for Peer-to-Peer Units X20/21 (CAN-Bus) X40/41 (Multi-function) <i>unshielded flat cable</i>	UK: CM469036U001 Germany: KK.6310.0001	RJ45 Plug 8 way RJ45 Plug 8 way
BUS Termination Plug X20/21 (CAN-Bus)	UK: CI469030 Germany: ST.0931.0001	RJ45 Plug 8 way
Cable for Host Units X20/21 (CAN-Bus) <i>2 twisted pairs, shielded cable unterminated at free-end</i>	UK: CM469029U010 Germany: KK.6310.0301	RJ45 Plug 8 way Round cable, 2TP, shielded
Adaptor Cable 631 X20/21 to 635/637/IBT COM2 (CAN-Bus) <i>2 twisted pairs, shielded cable</i>	UK: CM469031U003 Germany: KK.6310.0500	RJ45 Plug 8 way Sub-miniature D, 9 way male

9-2 Accessories

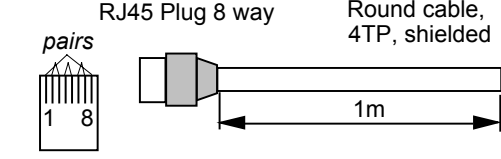
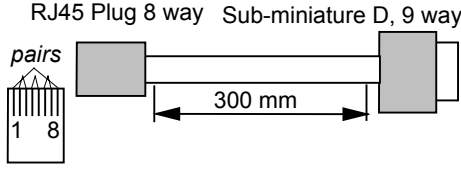
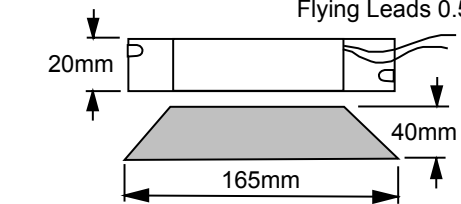
<p>Cable for Host Units X40/41 (Multi-function)</p> <p><i>4 twisted pairs, shielded cable unterminated at the free-end</i></p>	<p>UK: CM469033U010</p> <p>Germany: KK.6310.0401</p>	<p>RJ45 Plug 8 way Round cable, 4TP, shielded</p> 
<p>Adaptor Cable 631 X40/41 to 635/637 X40 (Multi-function)</p> <p><i>4 twisted pairs, shielded cable</i></p>	<p>UK: CM469034U003</p> <p>Germany: KK.6310.0600</p>	<p>RJ45 Plug 8 way Sub-miniature D, 9 way female</p> 
<p>Brake Resistor A resistor fitted externally for transient braking operations</p> <p><i>33Ω, 100W - overload capability approximately 5000%/0.5 seconds</i></p>	<p>UK: CZ469019</p> <p>Germany: ZU.5003.1001</p>	<p>Flying Leads 0.5m</p> 

REFERENCE TABLES

ASCII Table

BINARY				b ₆	0	0	0	0	1	1	1	1
				b ₅	0	0	1	1	0	0	1	1
				b ₄	0	1	0	1	0	1	0	1
b ₃	b ₂	b ₁	b ₀	HEX	0x	1	2	3	4	5	6	7
0	0	0	0	x0	NUL	DLE	SP	0	@	P	`	p
0	0	0	1	1	SOH	DC ₁	!	1	A	Q	a	q
0	0	1	0	2	STX	DC ₂	"	2	B	R	b	r
0	0	1	1	3	ETX	DC ₃	#	3	C	S	c	s
0	1	0	0	4	EOT	DC ₄	\$	4	D	T	d	t
0	1	0	1	5	ENQ	NAK	%	5	E	U	e	u
0	1	1	0	6	ACK	SYN	&	6	F	V	f	v
0	1	1	1	7	BEL	ETB	'	7	G	W	g	w
1	0	0	0	8	BS	CAN	(8	H	X	h	x
1	0	0	1	9	HT	EM)	9	I	Y	i	y
1	0	1	0	A	LF	SUB	*	:	J	Z	j	z
1	0	1	1	B	VT	ESC	+	;	K	[k	{
1	1	0	0	C	FF	FS	,	<	L	\	l	
1	1	0	1	D	CR	GS	-	=	M]	m	}
1	1	1	0	E	SO	RS	.	>	N	^	n	~
1	1	1	1	F	SI	US	/	?	O	_	o	DEL

10-2 Reference Tables

Decimal/Hexadecimal Table

	0	1	2	3	4	5	6	7	8	9
0	0000	0001	0002	0003	0004	0005	0006	0007	0008	0009
10	000A	000B	000C	000D	000E	000F	0010	0011	0012	0013
20	0014	0015	0016	0017	0018	0019	001A	001B	001C	001D
30	001E	001F	0020	0021	0022	0023	0024	0025	0026	0027
40	0028	0029	002A	002B	002C	002D	002E	002F	0030	0031
50	0032	0033	0034	0035	0036	0037	0038	0039	003A	003B
60	003C	003D	003E	003F	0040	0041	0042	0043	0044	0045
70	0046	0047	0048	0049	004A	004B	004C	004D	004E	004F
80	0050	0051	0052	0053	0054	0055	0056	0057	0058	0059
90	005A	005B	005C	005D	005E	005F	0060	0061	0062	0063
100	0064	0065	0066	0067	0068	0069	006A	006B	006C	006D
110	006E	006F	0070	0071	0072	0073	0074	0075	0076	0077
120	0078	0079	007A	007B	007C	007D	007E	007F	0080	0081
130	0082	0083	0084	0085	0086	0087	0088	0089	008A	008B
140	008C	008D	008E	008F	0090	0091	0092	0093	0094	0095
150	0096	0097	0098	0099	009A	009B	009C	009D	009E	009F
160	00A0	00A1	00A2	00A3	00A4	00A5	00A6	00A7	00A8	00A9
170	00AA	00AB	00AC	00AD	00AE	00AF	00B0	00B1	00B2	00B3
180	00B4	00B5	00B6	00B7	00B8	00B9	00BA	00BB	00BC	00BD
190	00BE	00BF	00C0	00C1	00C2	00C3	00C4	00C5	00C6	00C7
200	00C8	00C9	00CA	00CB	00CC	00CD	00CE	00CF	00D0	00D1
210	00D2	00D3	00D4	00D5	00D6	00D7	00D8	00D9	00DA	00DB
220	00DC	00DD	00DE	00DF	00E0	00E1	00E2	00E3	00E4	00E5
230	00E6	00E7	00E8	00E9	00EA	00EB	00EC	00ED	00EE	00EF
240	00F0	00F1	00F2	00F3	00F4	00F5	00F6	00F7	00F8	00F9
250	00FA	00FB	00FC	00FD	00FE	00FF	0100	0101	0102	0103
260	0104	0105	0106	0107	0108	0109	010A	010B	010C	010D
270	010E	010F	0110	0111	0112	0113	0114	0115	0116	0117
280	0118	0119	011A	011B	011C	011D	011E	011F	0120	0121
290	0122	0123	0124	0125	0126	0127	0128	0129	012A	012B
300	012C	012D	012E	012F	0130	0131	0132	0133	0134	0135
310	0136	0137	0138	0139	013A	013B	013C	013D	013E	013F
320	0140	0141	0142	0143	0144	0145	0146	0147	0148	0149
330	014A	014B	014C	014D	014E	014F	0150	0151	0152	0153
340	0154	0155	0156	0157	0158	0159	015A	015B	015C	015D
350	015E	015F	0160	0161	0162	0163	0164	0165	0166	0167
360	0168	0169	016A	016B	016C	016D	016E	016F	0170	0171
370	0172	0173	0174	0175	0176	0177	0178	0179	017A	017B
380	017C	017D	017E	017F	0180	0181	0182	0183	0184	0185
390	0186	0187	0188	0189	018A	018B	018C	018D	018E	018F
400	0190	0191	0192	0193	0194	0195	0196	0197	0198	0199
410	019A	019B	019C	019D	019E	019F	01A0	01A1	01A2	01A3
420	01A4	01A5	01A6	01A7	01A8	01A9	01AA	01AB	01AC	01AD
430	01AE	01AF	01B0	01B1	01B2	01B3	01B4	01B5	01B6	01B7
440	01B8	01B9	01BA	01BB	01BC	01BD	01BE	01BF	01C0	01C1
450	01C2	01C3	01C4	01C5	01C6	01C7	01C8	01C9	01CA	01CB
460	01CC	01CD	01CE	01CF	01D0	01D1	01D2	01D3	01D4	01D5
470	01D6	01D7	01D8	01D9	01DA	01DB	01DC	01DD	01DE	01DF
480	01E0	01E1	01E2	01E3	01E4	01E5	01E6	01E7	01E8	01E9
490	01EA	01EB	01EC	01ED	01EE	01EF	01F0	01F1	01F2	01F3

Decimal/Hexadecimal Table

	0	1	2	3	4	5	6	7	8	9
500	01F4	01F5	01F6	01F7	01F8	01F9	01FA	01FB	01FC	01FD
510	01FE	01FF	0200	0201	0202	0203	0204	0205	0206	0207
520	0208	0209	020A	020B	020C	020D	020E	020F	0210	0211
530	0212	0213	0214	0215	0216	0217	0218	0219	021A	021B
540	021C	021D	021E	021F	0220	0221	0222	0223	0224	0225
550	0226	0227	0228	0229	022A	022B	022C	022D	022E	022F
560	0230	0231	0232	0233	0234	0235	0236	0237	0238	0239
570	023A	023B	023C	023D	023E	023F	0240	0241	0242	0243
580	0244	0245	0246	0247	0248	0249	024A	024B	024C	024D
590	024E	024F	0250	0251	0252	0253	0254	0255	0256	0257
600	0258	0259	025A	025B	025C	025D	025E	025F	0260	0261
610	0262	0263	0264	0265	0266	0267	0268	0269	026A	026B
620	026C	026D	026E	026F	0270	0271	0272	0273	0274	0275
630	0276	0277	0278	0279	027A	027B	027C	027D	027E	027F
640	0280	0281	0282	0283	0284	0285	0286	0287	0288	0289
650	028A	028B	028C	028D	028E	028F	0290	0291	0292	0293
660	0294	0295	0296	0297	0298	0299	029A	029B	029C	029D
670	029E	029F	02A0	02A1	02A2	02A3	02A4	02A5	02A6	02A7
680	02A8	02A9	02AA	02AB	02AC	02AD	02AE	02AF	02B0	02B1
690	02B2	02B3	02B4	02B5	02B6	02B7	02B8	02B9	02BA	02BB
700	02BC	02BD	02BE	02BF	02C0	02C1	02C2	02C3	02C4	02C5
710	02C6	02C7	02C8	02C9	02CA	02CB	02CC	02CD	02CE	02CF
720	02D0	02D1	02D2	02D3	02D4	02D5	02D6	02D7	02D8	02D9
730	02DA	02DB	02DC	02DD	02DE	02DF	02E0	02E1	02E2	02E3
740	02E4	02E5	02E6	02E7	02E8	02E9	02EA	02EB	02EC	02ED
750	02EE	02EF	02F0	02F1	02F2	02F3	02F4	02F5	02F6	02F7
760	02F8	02F9	02FA	02FB	02FC	02FD	02FE	02FF	0300	0301
770	0302	0303	0304	0305	0306	0307	0308	0309	030A	030B
780	030C	030D	030E	030F	0310	0311	0312	0313	0314	0315
790	0316	0317	0318	0319	031A	031B	031C	031D	031E	031F
800	0320	0321	0322	0323	0324	0325	0326	0327	0328	0329
810	032A	032B	032C	032D	032E	032F	0330	0331	0332	0333
820	0334	0335	0336	0337	0338	0339	033A	033B	033C	033D
830	033E	033F	0340	0341	0342	0343	0344	0345	0346	0347
840	0348	0349	034A	034B	034C	034D	034E	034F	0350	0351
850	0352	0353	0354	0355	0356	0357	0358	0359	035A	035B
860	035C	035D	035E	035F	0360	0361	0362	0363	0364	0365
870	0366	0367	0368	0369	036A	036B	036C	036D	036E	036F
880	0370	0371	0372	0373	0374	0375	0376	0377	0378	0379
890	037A	037B	037C	037D	037E	037F	0380	0381	0382	0383
900	0384	0385	0386	0387	0388	0389	038A	038B	038C	038D
910	038E	038F	0390	0391	0392	0393	0394	0395	0396	0397
920	0398	0399	039A	039B	039C	039D	039E	039F	03A0	03A1
930	03A2	03A3	03A4	03A5	03A6	03A7	03A8	03A9	03AA	03AB
940	03AC	03AD	03AE	03AF	03B0	03B1	03B2	03B3	03B4	03B5
950	03B6	03B7	03B8	03B9	03BA	03BB	03BC	03BD	03BE	03BF
960	03C0	03C1	03C2	03C3	03C4	03C5	03C6	03C7	03C8	03C9
970	03CA	03CB	03CC	03CD	03CE	03CF	03D0	03D1	03D2	03D3
980	03D4	03D5	03D6	03D7	03D8	03D9	03DA	03DB	03DC	03DD
990	03DE	03DF	03E0	03E1	03E2	03E3	03E4	03E5	03E6	03E7

TECHNICAL SPECIFICATIONS

General Data

Environmental Details	
The unit MUST be mounted inside a suitable cubicle.	
Operating Temperature	0°C to 40°C (derate the output current by 2% per °C between 40-50°C) Operating temperature is defined as the ambient temperature to the immediate surround of the Servo Drive, when the Servo Drive and other equipment adjacent to it is operating at worst case conditions.
Storage Temperature	-25°C to +55°C
Shipping Temperature	-25°C to +70 °C
Product Enclosure Rating	Cubicle Mounted IP20
Vibration Test	In accordance with DIN IEC 68-2-6, test FC Condition for testing: frequency range : 10...57Hz, 57Hz...150Hz amplitude : 0.075mm acceleration : 1g test time per axis : 10 frequency/sweep cycle frequency sweep speed : 1 minute
Altitude	If > 1000 metres above sea level, derate Motor Power rating by 1% per 100 metres
Humidity	Maximum 85% relative humidity at 40°C non-condensing
Atmosphere	Non flammable, non corrosive and dust free
Climatic Conditions	Class 3k3, as defined by EN50178 (1998)
Safety	
Overvoltage Category	Overvoltage Category III
Pollution Degree	Pollution Degree 2
Europe	When fitted inside a cubicle this product conforms with the Low Voltage Directive 73/23/EEC with amendment 93/68/EEC, Article 13 and Annex III using EN50178 (1998) to show compliance.
North America/Canada	Complies with the requirements of UL508C as an open-type drive

Insulation Concept	
Insulation Concept	<p>The diagram illustrates the insulation concept for the servo drive. It shows a central vertical bar representing the main insulation barrier. To the left of this barrier are various signal terminals: X15 (RS232), X20 and X21 (CAN-Bus), X10 (analog), X10 (digital), X30 (Resolver, Motortemp. 1), and X40, X41 (multi-function). To the right of the barrier are Power Terminals (L1, L2/N), Motor Terminals (M1, M2, M3), and External Brake Resistor Terminals (DBR1, DBR2). A ground symbol is shown at the bottom left, and a PE (Protective Earth) terminal is shown at the bottom right. A legend at the bottom left defines the hatching patterns: diagonal lines for SELV according to EN 50178 (double isolation) and cross-hatching for Extra-low voltage isolation by opto-coupler, for immunity (not safety).</p>

Cabling Requirements for EMC Compliance

* For cable lengths longer than 15 and up to 50 metres contact Eurotherm Drives.

	Resolver	Power Supply Cable	Motor Cable	Brake Resistor Cable	Signal/Control Cable
Cable Type (for EMC Compliance)	Screened	Unscreened	Screened/ armoured	Screened	Screened
Segregation	From all other wiring (sensitive)	From all other wiring (clean)	From all other wiring (noisy)		From all other wiring (sensitive)
Length Limitations With Internal AC Supply EMC Filter	50 metres	Unlimited	15 metres domestic, 50 metres * industrial	2metres	25 metres
Screen to Earth Connection	Both ends		Both ends	Both ends	Both ends

Fuse Rating and Recommended Wire Sizes

Refer to Chapter 9: "Accessories"

Local wiring regulations always take precedence.

* European wire sizes are based on EN60204-1 (1993) for PVC single-core cable bunched or in trunking given a 70°C maximum conductor temperature under normal conditions in a 45°C ambient.

✦ North American wire sizes are based on NEC/NFPA-70 for ampacities of thermoplastic-insulated (60°C) copper conductors assuming not more than three current-carrying conductors in raceway or cable, based on ambient temperature of 30°C. The wire sizes allow for an ampacity of 125% of the rated input and output amperes for motor branch-circuit conductors as specified in NEC/NFPA-70.

631 Product Code	Input			Output	
	Input Fuse Rating (A)	* European Wire Size (45°C) (mm ²)	✦ North American Wire Size (AWG)	* European Wire Size (45°C) [for reduced cable power losses] (mm ²)	✦ North American Wire Size (AWG)
631/001	10.0	1.0	16	1.5	16
631/002	10.0	1.0	16	1.5	16
631/004	10.0	1.5	12	1.5 [2.5]	16 [14]
631/006	20.0	2.5	12	1.5 [2.5]	16 [14]

Terminal Block Wire Sizes

Wire sizes should be chosen with respect to the operating conditions and your local National Electrical Safety Installation Requirements.

Power Terminals (X1)	Maximum acceptance for aperture: 12 AWG (3.3mm ²)
Control Terminals (X10)	0.08mm ² - 2.1mm ² (28 AWG - 14 AWG)
Communication Terminals (X20 / X21, X40 / X41)	26 AWG
<i>For information:</i> 12 AWG (3.3mm ²), 14 AWG (2.5mm ²), 18 AWG (0.8mm ²), 20 AWG (0.5mm ²) 22 AWG (0.3mm ²)	

Earthing/Safety Details

Refer to Chapter 12 : “Certification for the Servo Drive”.

Earthing	Permanent earthing is mandatory on all units. <ul style="list-style-type: none"> Use a copper protective earth conductor 10mm² minimum cross-section, or install a second conductor in parallel with the protective conductor to a separate protective earth terminal The conductor itself must meet local requirements for a protective earth conductor
Input Supply Details (TN) and (IT)	Units with the internal filter are only suitable for use on earth referenced supplies (TN). Units without the filter are suitable for earth (TN) or non-earth referenced (IT) supplies.

Power Circuit

Electrical separation from control circuit	In accordance with VDE 0160 / EN 50178 or UL508C
Short-circuit and to frame proof for	≤ 1000 releasings
Overvoltage monitoring DC Bus	Maximum 400V dc ±5V dc
Undervoltage monitoring	100V dc / 70V ac
Overtemperature of Power Stage	Supervised
Carrier frequency	4.75kHz
Frequency of current ripple	9.5kHz
Power losses:	
Fan, internal electronic Power stage per A	15W 9W/A

Control Terminals (X10)

Additional galvanic separation from power and control circuit	
Nominal voltage of the inputs and outputs	24V DC
Number of outputs Signal outputs via OPTO coupler	2 $U_{max} = 30V DC$; $I = 0..60 mA$; short circuit proof, resistive load
Number of inputs Signal outputs via OPTO coupler	4 $L = 0..7 V DC$ or open $H = 15..30 V DC$ $I_{in} 24VDC @ 8 mA$
Reaction time of the inputs X10.7, X10.8	> 2 ms
Reaction time of the inputs X10.9, X10.10 (configured as latch input “see chapter 3”)	0,02 ms
Effect of cycle-time	10 μs

Also see Chapter 4: “Operating the Servo Drive” - Configuring the I/Os (X10)

11-4 Technical Specifications

Resolver Conversion (X30)

The specified data refers to the standard resolver interface, operated with the Eurotherm Resolver R 21-T05, R15-T05.

Carrier frequency	$f_t = 4.75\text{kHz}$
Linearity error of the actual value signal	1%
Ripple of the actual value signal	2%
Maximum position resolution for one revolution	16384 increments, 14 bit
Absolute position accuracy	$\pm 0.7^\circ$
Relative position accuracy	$\pm 0.08^\circ$

Digital Communication (X15, X20/X21)

X15 - RS232 (Service Interface)

Standard setting	19200 baud, 8 databits, 1 startbit, 1 stopbit, parity: even
Protocol	See the separate manual
X20 / X21 - CAN-Bus	
Protocol	See the separate manual

X40/X41 - Multi-function Input/Output

Plug model	Modular Plug AMP, 8-pole
Internal hardware connection from X40 to X41	direct wired 1:1 (X40 = X41)
Maximum input or output frequency	200kHz
Maximum cable length connected to galvanical insulated terminals (Encoder, controls)	25metres, for extended distances please contact Eurotherm Drives
Maximum cable length connected to ground related terminals (other drives, controls)	2 metres (ensure good common grounding)
Maximum number of signal inputs when configured as an incremental output device	8
Output signals	driver model: Type RS485
differential logic level	Low $\leq 0.5\text{V}$ High $\geq 2.5\text{V}$
nominal range	0.0 ... 5.0V
Input signals	receiver model: Type RS422
differential input level	differential minimum = 0.2V
nominal range	0.0 ... 5.0V
Nominal signal difference	1.0V

Controller System

System run-up time after switching on	6s maximum
Data memory / organization	Flash Eprom 256KB RAM 64KB EEPROM 512 Byte

Digital Control	
Current Control	
Settings	According to factory specifications or motor data
Current Limits	Set by the Parameter Menu
Speed Control	
Settings	Set by the Parameter Menu
Differential Setpoint Input Analog	$U_{\text{soll}} = 10\text{V}$, can be normed; $R_i = 10\text{k}$
Resolution (including sign)	12 bit
Digital Setpoint Input	Via interfaces

Product Specific Data

IMPORTANT: Motor power, output current and input current must not be exceeded under steady state operating conditions.

631 Product Code - block 2	001	002	004	006
EMC Compliance				
All models	European Community Directive 89/336/EEC			
All models	EN50082-1 (1992) and EN50082-2 (1995) for immunity			
If fitted with an internal filter	EN50081-1 (1992) and EN50081-2 (1994)			
Input				
Supply details (note 3)(refer to Earthing/Safety Details table)	220/240V \pm 10%, 50/60 Hz, single phase (IT/TN)			
Maximum continuous input current (In)	3	5,5	9,6	11
Fuse rating (note 2)	10A	10A	10A	20A
Power-on current limit	Soft start: capacitor pre-charge via 330 Ω			
Line filter	Internal when filter option is supplied. According to EN50081-1 (1992), residual area, maximum motor cable length is 15m			
Earth leakage current	7.5mA			
Supply short-circuit capacity	5000A maximum			
Output				
Sinewave voltage at Un	210/230			
Derating of Unr when loaded	Refer to Chapter 13: "Application Notes"			
Rated output current rms	1A	2A	4A	6A
Output overload motoring	125% for 32s 150% for 18s 175% for 12s 200% for 9s			
Minimum motor inductance (between terminals)	12.0mH	6.0mH	3.0mH	2.0mH
Brake Circuit				
Brake circuit setpoint dc	380V			
Internal Brake Resistor				
Internal brake resistor	410 Ω internal build			
Internal brake circuit power nominal/maximum	8W / 352W internal			
External Brake Resistor (DBR1 & DBR2)				
Minimum braking resistor external (note 1)	3 Ω externally connectable on terminals DBR1, DBR2			
Nominal/maximum power external	100W / 4375W external			

Notes:

- 1) Use only Eurotherm approved types
- 2) Fuses, medium speed or according to suggestion:

Fuse and item number	10A	CH 430014
	20A	CH 430024
Fuse holder 10x38mm		CP051602
- 3) Devices with built-in filter may be operated only in grounded networks (TN-Networks) with permanently connected protective conductor.

CERTIFICATION FOR THE SERVO DRIVE

Requirements for EMC Compliance

All Variable Speed Drives (VSDs) potentially produce electrical emissions which are radiated into the environment and conducted back into the ac supply. VSDs are inherently immune to any additional external electrical noise. The following information is provided to maximise the Electro Magnetic Compatibility (EMC) of VSDs and systems in their intended operating environment, by minimising their emissions and maximising their immunity.

Minimising Radiated Emissions

EN55011/EN55022 radiated emission measurements are made between 30MHz and 1GHz in the far field at a distance of 10 to 30 metres. Limits lower than 30MHz or in close proximity are not specified. Emissions from individual components tend to be additive.

- Use a screened/armoured cable between VSD/cubicle and motor containing the motor protective earth (PE) connection. It should have a 360° screen termination. Earth screen at both ends connecting to the motor frame and cubicle. Maintain the screen integrity using 360° terminations.

Note: *Some hazardous area installations may preclude direct earthing at both ends of the screen, in this case earth one end via a 1 μ F 50Vac capacitor, and the other as normal.*

- Keep unshielded cable as short as possible inside the cubicle.
- Always maintain the integrity of the shield.
- If the cable is interrupted to insert contactors etc., re-connect the screen using the shortest possible route.
- Keep the length of screen stripped-back as short as possible when making screen connections.
- Ideally use 360° screen terminations using cable glands or 'U' clips on power screen rails.

If a shielded cable is not available, lay unshielded motor cables in a metal conduit which will act as a shield. The conduit must be continuous with a direct electrical contact to the VSD and motor housing. If links are necessary, use braid with a minimum cross sectional area of 10mm².

Note: *Some motor gland boxes and conduit glands are made of plastic, if this is the case, then braid must be connected between the screen and the chassis. In addition at the motor end, ensure that the screen is electrically connected to the motor frame since some terminal boxes are insulated from the frame by gasket/paint.*

Earthing Requirements

IMPORTANT: Protective earthing always takes precedence over EMC earthing.

Protective Earth (PE) Connections

Note: *In accordance with installations to EN60204, only one protective earth conductor is permitted at each protective earth terminal contacting point.*

Local wiring regulations may require the protective earth connection of the motor to be connected locally, i.e. not as specified in these instructions. This will not cause shielding problems because of the relatively high RF impedance of the local earth connection.

EMC Earth Connections

For compliance with EMC requirements, we recommend that the "0V/signal ground" is separately earthed. When a number of units are used in a system, these terminals should be connected together at a single, local earthing point.

12-2 Certification for the Servo Drive

Control and signal cables for the encoder and all analog inputs normally require screening with the screen connected only at the VSD end. However, if high frequency noise is still a problem, earth screen at the non VSD end via a 0.1µF capacitor.

Note: Connect the screen (at the VSD end) to the VSD protective earth point, and not to the control board terminals.

Cabbling Requirements

Note: Refer to Chapter 11: "Technical Specifications" for additional Cabbling Requirements.

Planning Cable Runs

- Use the shortest possible motor cable lengths.
- Use a single length of cable to a star junction point to feed multiple motors.
- Keep electrically noisy and sensitive cables apart.
- Keep electrically noisy and sensitive parallel cable runs to a minimum. Separate parallel cable runs by at least 0.25 metres. For runs longer than 10 metres, separation should be increased proportionally. For example if the parallel runs were 50m, then the separation would be $(50/10) \times 0.25\text{m} = 1.25\text{m}$.
- Sensitive cables should cross noisy cables at 90°.
- Never run sensitive cables close or parallel to the motor and braking chopper circuit for any distance.
- Never run supply or motor cables in the same bundle as the signal/control and feedback cables, even if they are screened.

Increasing Motor Cable Length

Because cable capacitance and hence conducted emissions increase with motor cable length, conformance to EMC limits is only guaranteed with the internal ac supply filter option.

Screened/armoured cable has significant capacitance between the conductors and screen which increases linearly with cable length (typically 200pF/m but varies with cable type and current rating).

Long cable lengths may have the following undesirable effects:

- Tripping on 'overcurrent' as the cable capacitance is charged and discharged at the switching frequency.
- Producing increased conducted emissions which degrade the performance of the EMC filter due to saturation.
- Causing RCDs (Residual Current Devices) to trip due to increased high frequency earth current.
- Producing increased heating inside the EMC ac supply filter from the increased conducted emissions.

These effects can be overcome by adding chokes or output filters at the output of the VSD.

EMC Installation Options

The unit, when installed for Class A or Class B operation, will be compliant with EN55011 (1991)/ EN55022 (1994) for radiated emissions, as described below.

Screening & Earthing (wall mounted, Class A)

IMPORTANT: This unit must be mounted inside a suitable control cubicle requiring a tool for opening to maintain compliance with the European Electrical Safety Standard VDE0160 (1994) /EN50178 (1998).

The unit is installed for Class A operation when wall mounted inside a cubicle and having complied with all cabling requirements.

Note: The installation requirements of local safety standards must be achieved regarding the safety of electrical equipment for machines.

- A single-star point earthing policy as shown in **Fehler! Verweisquelle konnte nicht gefunden werden.** is required.
- The protective earth connection (PE) to the motor must be run inside the screened cable between the motor and VSD and be connected to the protective earth terminal in the gland box, or on the VSD.

Note: Refer to Chapter 11: "Technical Specifications" for details on Cabling Requirements.

Screening & Earthing (cubicle mounted, Class B)

Note: The installation requirements of local safety standards must be achieved regarding the safety of electrical equipment for machines.

The unit is installed for Class B operation when mounted inside a cubicle having 10dB attenuation between 30 and 100MHz (typically the attenuation provided by a metal cabinet with no aperture of dimension greater than 0.15m), using the internal ac supply EMC filter and having met all cabling requirements.

Note: Radiated magnetic and electric fields inside the cubicle may be high and any components fitted inside must be sufficiently immune.

The VSD and associated equipment are mounted onto a conducting, metal mounting panel. Do not use cubicle constructions that use insulating mounting panels or undefined mounting structures. Cables between the VSD and motor must be screened or armoured and terminated at the entrance to the cubicle.

Single VSD - Single Motor

Apply a single point earthing strategy for a single VSD mounted in a cubicle as shown below.

The protective earth connection (PE) to the motor must be run inside the screened cable between the motor and VSD and be connected to the motor protective earth terminal on the VSD.

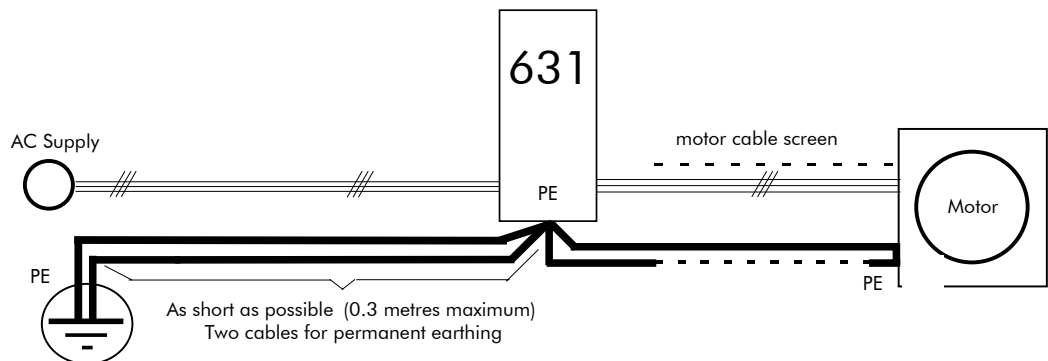
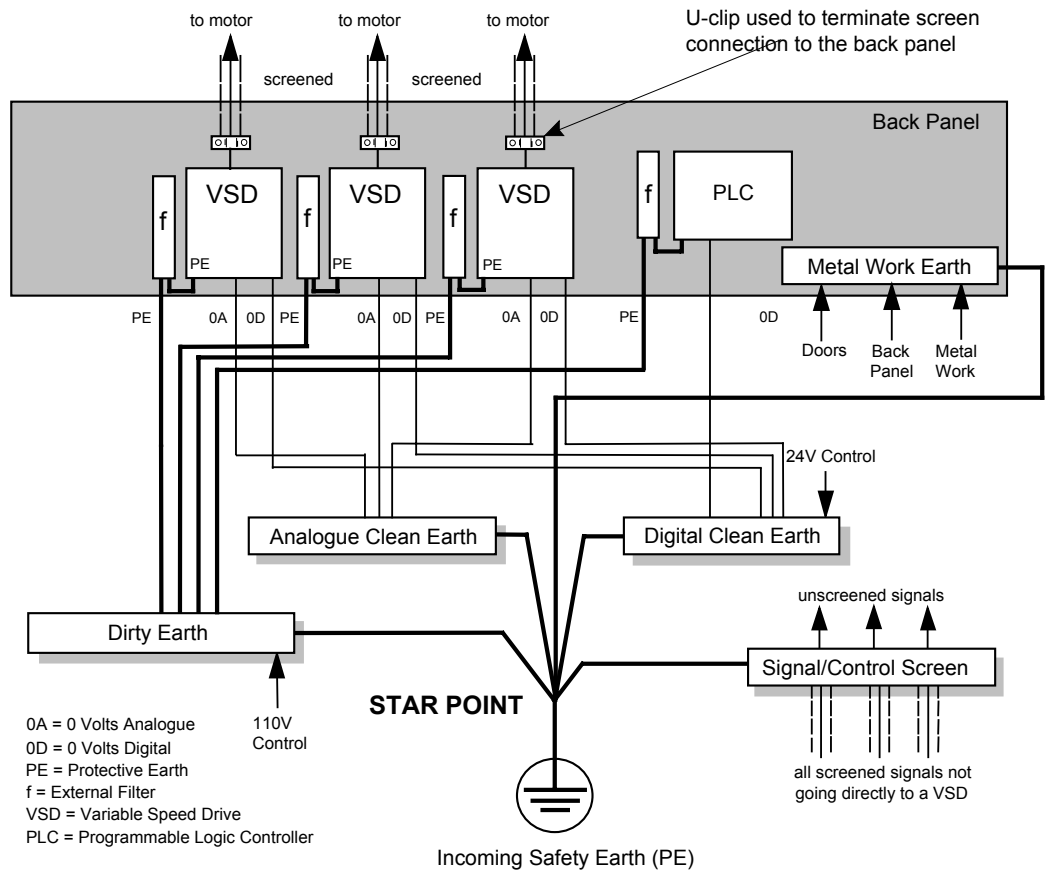

Figure 12-1 EMC and Safety Earthing Cabling

12-4 Certification for the Servo Drive

Star Point Earthing



A star-point earthing policy separates 'noisy' and 'clean' earths. Four separate earth busbars (three are insulated from the mounting panel) connect to a single earth point (star point) near the incoming safety earth from the main supply. Flexible, large cross-section cable is used to ensure a low HF impedance. Busbars are arranged so that connection to the single earth point is as short as possible.

1 Clean Earth Busbar (insulated from the mounting panel)

Used as a reference point for all signal and control cabling. This may be further subdivided into an analog and a digital reference busbar, each separately connected to the star earthing point. The digital reference is also used for any 24V control.

2 Dirty Earth Busbar (insulated from the mounting panel)

Used for all power earths, i.e. protective earth connection. It is also used as a reference for any 110 or 220V control used, and for the control transformer screen.

3 Metal Work Earth Busbar

The back panel is used as this earth busbar, and should provide earthing points for all parts of the cubicle including panels and doors. This busbar is also used for power screened cables which terminate near to (10cm) or directly into a VSD - such as motor cables, braking choppers and their resistors, or between VSDs - refer to the appropriate product manual to identify these. Use U-clips to clamp the screened cables to the back panel to ensure optimum HF connection.

4 Signal/Control Screen Earth Busbar (insulated from the mounting panel)

Used for signal/control screened cables which **do not** go directly to the VSD. Place this busbar as close as possible to the point of cable entry. 'U' clamp the screened cables to the busbars to ensure an optimum HF connection.

Sensitive Equipment

The proximity of the source and victim circuit has a large effect on radiated coupling. The electromagnetic fields produced by VSDs falls off rapidly with distance from the cabling/cubicle. Remember that the radiated fields from EMC compliant drive systems are measured at least 10m from the equipment, over the band 30-1000MHz. Any equipment placed closer than this will see larger magnitude fields, especially when very close to the Inverter.

Do not place magnetic/electric field sensitive equipment within 0.25 metres of the following parts of the VSD system:

- Variable Speed Drive (VSD)
- EMC output filters
- Input or output chokes/transformers
- The cable between VSD and motor (even when screened/armoured)
- Connections to external braking chopper and resistor (even when screened/armoured)
- Relays and contactors (even when suppressed)

From experience, the following equipment is particularly sensitive and requires careful installation.

- Any transducers which produce low level analog outputs (<1V) , e.g. load cells, strain gauges, thermocouples, piezoelectric transducers, anemometers, LVDTs
- Wide band width control inputs (>100Hz)
- AM radios (long and medium wave only)
- Video cameras and closed circuit TV
- Office personal computers
- Capacitive devices such as proximity sensors and level transducers
- Mains borne communication systems
- Equipment not suitable for operation in the intended EMC environment, i.e. with insufficient immunity to new EMC standards

Requirements for UL Compliance

Solid-State Motor Overload Protection

These devices provide Class 10 motor overload protection. The maximum internal overload protection level (current limit) is 200% for 9 seconds.

An external motor overload protective device must be provided by the installer where the motor has a full-load ampere rating of less than 50% of the drive output rating. Refer to Chapter 4: “Operating the Servo Drive” - Motor Overload Protection for user current limit adjustment information..

Internal motor overload is also provided for use with an external thermal device located within the winding of the motor. This protection cannot be evaluated by Underwriters Laboratories Inc. and hence it is the responsibility of the Installer and/or local Inspector to determine whether the overload protection is in compliance with the latest edition of the National Electrical Code, NEC/NFPA-70.

Short Circuit Rating

All models of this Inverter are suitable for use on a circuit capable of delivering not more than 5,000 RMS Symmetrical Amperes, 240V maximum.

Solid-State Short-Circuit Protection

These devices are provided with Solid-State Short-Circuit (output) Protection. Branch circuit protection requirements must be in accordance with the latest edition of the National Electrical Code NEC/NFPA-70.

Recommended Branch Circuit Protection

It is recommended that UL Listed (JDDZ) non-renewable cartridge fuses, Class K5 or H; or UL Listed (JDRX) renewable cartridge fuses, Class H, are installed upstream of the Inverter. Refer to Chapter 11: “Technical Specifications” - Power Details for recommended fuse ratings.

Motor Base Frequency

The motor base frequency rating is 500Hz maximum.

Field Wiring Temperature Rating

Use 75°C Copper conductors only.

Field Wiring Terminal Markings

For correct field wiring connections that are to be made to each terminal refer to Chapter 3: “Installing the Inverter” - Power Wiring Connections, and Control Wiring Connections.

Power Wiring Terminals

Model Recognition Product Code(Block 2 & 3)	Power Terminals (maximum wire size)	Brake Terminals DBR1, DBR2 (maximum wire size)
001/230	12 AWG (3.3mm ²)	12 AWG (3.3mm ²)
002/230	12 AWG (3.3mm ²)	12 AWG (3.3mm ²)
004/230	12 AWG (3.3mm ²)	12 AWG (3.3mm ²)
006/230	12 AWG (3.3mm ²)	12 AWG (3.3mm ²)

Field Grounding Terminals

The field grounding terminals are identified with the International Grounding Symbol (IEC Publication 417, Symbol 5019).



Operating Ambient Temperature

Heavy duty devices are considered acceptable for use in a maximum ambient temperature of 45°C (40°C for models with a Type 1 Enclosure). Normal duty devices are considered suitable for use in a maximum ambient temperature of 40°C for both ‘open type’ and Type 1 Enclosed models.

European Directives and the CE Mark

The following information is supplied to provide a basic understanding of the EMC and low voltage directives CE marking requirements. The following literature is recommended for further information:

- *Recommendations for Application of Power Drive Systems (PDS), European Council Directives - CE Marking and Technical Standardisation - (CEMEP)*

Available from your local trade association or Eurotherm Drives office

- *EMC Installation Guidelines for Modules and Systems - (Eurotherm Drives)*

Available from your local Eurotherm Drives office, part number HA388879

The European machines and drives manufacturers via their national trade associations have formed the European Committee of Manufacturers of Electrical Machines and Power Electronics (CEMEP). Eurotherm Drives and other major European drives manufacturers are working to the CEMEP recommendations on CE marking. The CE mark shows that a product complies with the relevant EU directives, in our case the Low Voltage Directive and, in some instances, the EMC Directive.

CE Marking for Low Voltage Directive

When installed in accordance with this manual, the 605C Inverter is CE marked by Eurotherm Drives Ltd in accordance with the low voltage directive (S.I. No. 3260 implements this LVD directive into UK law). An EC Declaration of Conformity (low voltage directive) is included at the end of this chapter.

CE Marking for EMC - Who is Responsible?

Note: *The specified EMC emission and immunity performance of this unit can only be achieved when the unit is installed to the EMC Installation Instructions given in this manual.*

According to S.I. No. 2373 which implements the EMC directive into UK law, the requirement for CE marking this unit falls into two categories:

1. Where the supplied unit has an intrinsic/direct function to the end user, then the unit is classed as **relevant apparatus**.
2. Where the supplied unit is incorporated into a higher system/apparatus or machine which includes (at least) the motor, cable and a driven load but is unable to function without this unit, then the unit is classed as a **component**.

■ **Relevant Apparatus - Eurotherm Drives Responsibility**

Occasionally, say in a case where an existing fixed speed motor - such as a fan or pump - is converted to variable speed with an add-on drive module (*relevant apparatus*), it becomes the responsibility of Eurotherm Drives to apply the CE mark and issue an EC Declaration of Conformity for the EMC Directive. This declaration and the CE mark is included at the end of this chapter.

■ **Component - Customer Responsibility**

The majority of Eurotherm Drives' products are classed as *components* and therefore we cannot apply the CE mark or produce an EC Declaration of Conformity in respect of EMC. It is therefore the manufacturer/supplier/installer of the higher system/apparatus or machine who must conform to the EMC directive and CE mark.

Legal Requirements for CE Marking

IMPORTANT: Before installation, clearly understand who is responsible for conformance with the EMC directive. Misappropriation of the CE mark is a criminal offence.

It is important that you have now defined who is responsible for conforming to the EMC directive, either:

12-8 Certification for the Servo Drive

■ Eurotherm Drives Responsibility

You intend to use the unit as *relevant apparatus*.

When the unit is factory-fitted with the internal EMC filter and installed following EMC installation instructions, it complies with the relevant standards indicated in the following tables.

The relevant declarations are to be found at the end of this chapter. The CE mark is displayed on the EC Declaration of Conformity (EMC Directive) provided at the end of this chapter.

■ Customer Responsibility

You intend to use the unit as a *component*, therefore you have a choice:

1. To use the factory-fitted internal EMC filter following EMC installation instructions, which may help you gain EMC compliance for the final machine/system.

Note: *An external filter may be used with units not fitted with the internal filter, however, due to the variables in your system Eurotherm cannot recommend a particular filter.*

2. To use a unit without an internal filter, but use a combination of global or local filtering and screening methods, natural migration through distance, or the use of distributed parasitic elements of the existing installation.

Note: *When two or more EMC compliant components are combined to form the final machine/system, the resulting machine/system may no longer be compliant, (emissions tend to be additive, immunity is determined by the least immune component). Understand the EMC environment and applicable standards to keep additional compliance costs to a minimum.*

Applying for CE Marking for EMC

We have supplied a Manufacturer's EMC Declaration at the end of this chapter that you can use as a basis for your own justification of overall compliance with the EMC directive. There are three methods of demonstrating conformity:

1. Self-certification to a relevant standard
2. Third party testing to a relevant standard
3. Writing a technical construction file stating the technical rationale as to why your final machine/system is compliant. An EMC "competent body" must then assess this and issue a technical report or certificate to demonstrate compliance.
Refer to Article 10(2) of Directive 89/336/EEC.

With EMC compliance, an EC Declaration of Conformity and the CE mark will be issued for your final machine/system.

IMPORTANT: Professional end users with EMC expertise who are using drive modules and cubicle systems defined as components who supply, place on the market or install the relevant apparatus must take responsibility for demonstrating EMC conformance and applying the CE mark and issuing an EC Declaration of Conformity.

Which Standards Apply?

Power Drive Product Specific or Generic Standards

The standards that may apply to this unit come under two broad categories:

1. Emission - these standards limit the interference caused by operating (this) drive module.
2. Immunity - these standards limit the effect of interference (on this unit) from other electrical and electronic apparatus.



Certification for the Servo Drive 12-9

Conformance can be demonstrated using the Generic Standards or the Product Specific Standard.

The following tables indicate, for the two methods of compliance, the standards that the unit may comply with if installed and used correctly.

Generic Standards

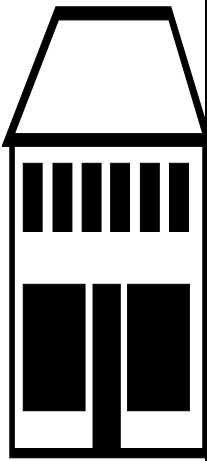
Assuming installation to EMC instructions in this manual
 "Filter" refers to the factory-fitted internal filter.

Installation	Generic Standards		Unit used as Relevant Apparatus		Unit used as a Component	
			filter (EMC compliance)	no filter	filter (EMC compliance may be applied for)	no filter
			enclosure	enclosure	enclosure	enclosure
 Residential, supplied directly from public electricity supply Residential, supplied directly from public electricity supply	Immunity only	EN50082-1(1992) • see below for referenced standards	✓	✓	✓	✓
	<u>Radiated Emissions</u>	EN50081-1 (1992) With 15db attenuation	✓	✓	✓	✓
	<u>Conducted Emissions</u>	EN50081-1 (1992) Maximum 15m shielded motor cable	✓		✓	
 Commercial and light industry, supplied directly from public electricity supply	Immunity only	EN50082-1(1992) • see below for referenced standards	✓	✓	✓	✓
	<u>Radiated Emissions</u>	EN50081-1 (1992) With 15db attenuation	✓	✓	✓	✓
	<u>Conducted Emissions</u>	EN50081-1 (1992) Maximum 15m shielded motor cable	✓		✓	
 Industrial installation with a separate transformer station	Radiated RF Emission	EN55011 (Class A) or EN50081-2(1994)	✓	✓	✓	✓
	Conducted RF Emission	EN55011 (Class A) or EN50081-2(1994)	✓		✓	
	Immunity	EN50082-2 (1992) • see below for referenced standards	✓	✓	✓	✓

• Standards for Immunity:

12-10 Certification for the Servo Drive

IEC1000-4-2	Electrostatic discharge (e.g. from electrostatically charged persons)	IEC1000-4-4:	Fast electrical transients (burst) (e.g. from opening contacts in inductive circuits)
IEC1000-4-3	Electromagnetic fields (e.g. from portable telephones)	IEC1000-4-5:	Voltage surges (e.g. on local lightning strikes)
ENV50140:	Pulse Modulated Electromagnetic Field	IEC1000-4-8	Power Frequency Magnetic Field
ENV50141:	Radio-Frequency Common-mode	IEC1000-4-11	Voltage Dips Short Interruptions and voltage variations

Product Specific Standard EN61800-3

Assuming installation to EMC instructions in this manual
 "Filter" refers to the factory-fitted internal filter.

Installation	Sales	Performance Required		Unit used as Relevant Apparatus		Unit used as a Component	
				filter (EMC compliance)	no filter	filter (EMC compliance may be applied for)	no filter
				enclosure	enclosure	enclosure	enclosure
FIRST ENVIRONMENT  Environment includes domestic premises Includes commercial and industrial installations supplied directly from public electricity supply which also supplies domestic premises	<i>Unrestricted Sales Distribution:</i> Sales is not dependent on the EMC competence of the customer	Radiated RF Emission	Class B performance models	✓	✓	✓	✓
		Conducted RF Emission	Class B performance models	✓		✓	
	<i>Restricted Sales Distribution:</i> Sales restricted to customers with technical competence in EMC requirements of drives	Radiated RF Emission	Class A performance	✓	✓	✓	✓
		Conducted RF Emission	Class A performance	✓		✓	
		Immunity	• See below for referenced standards	✓	✓	✓	✓
SECOND ENVIRONMENT  All environments except domestic premises. All commercial, light industry and industrial installations, supplied from an intermediate transformer or directly from public electricity supply, which do not supply domestic premises.		RF Emission	EMC measures do not have to be implemented If interference in a neighbouring installation occurs, the operator is responsible for taking measures to prevent interference. In this case the required emission levels must be adhered to at the point of supply to the affected neighbouring installation	✓	✓	✓	✓
		Immunity	• See below for referenced standards.	✓	✓	✓	✓

• Standards for Immunity:

IEC1000-4-2	Electrostatic discharge (e.g. from electrostatically charged persons)	IEC1000-4-9	Pulsed magnetic field
IEC1000-4-3/6	Electromagnetic fields (e.g. from portable telephones)	IEC1000-4-11	Voltage Dips Short Interruptions and voltage variations
IEC1000-4-4	Fast electrical transients (burst) (e.g. from opening contacts in inductive circuits)	IEC1000-4-13*	Harmonics and interharmonics
IEC1000-4-5	Voltage surges (e.g. on local lightning strikes).	IEC1000-4-14*	Mains Voltage Fluctuations
IEC1000-4-8	Power Frequency Magnetic Field	IEC1000-4-16	Power Frequency Common mode
		IEC1000-4-27*	Unbalance

12-12 Certification for the Servo Drive

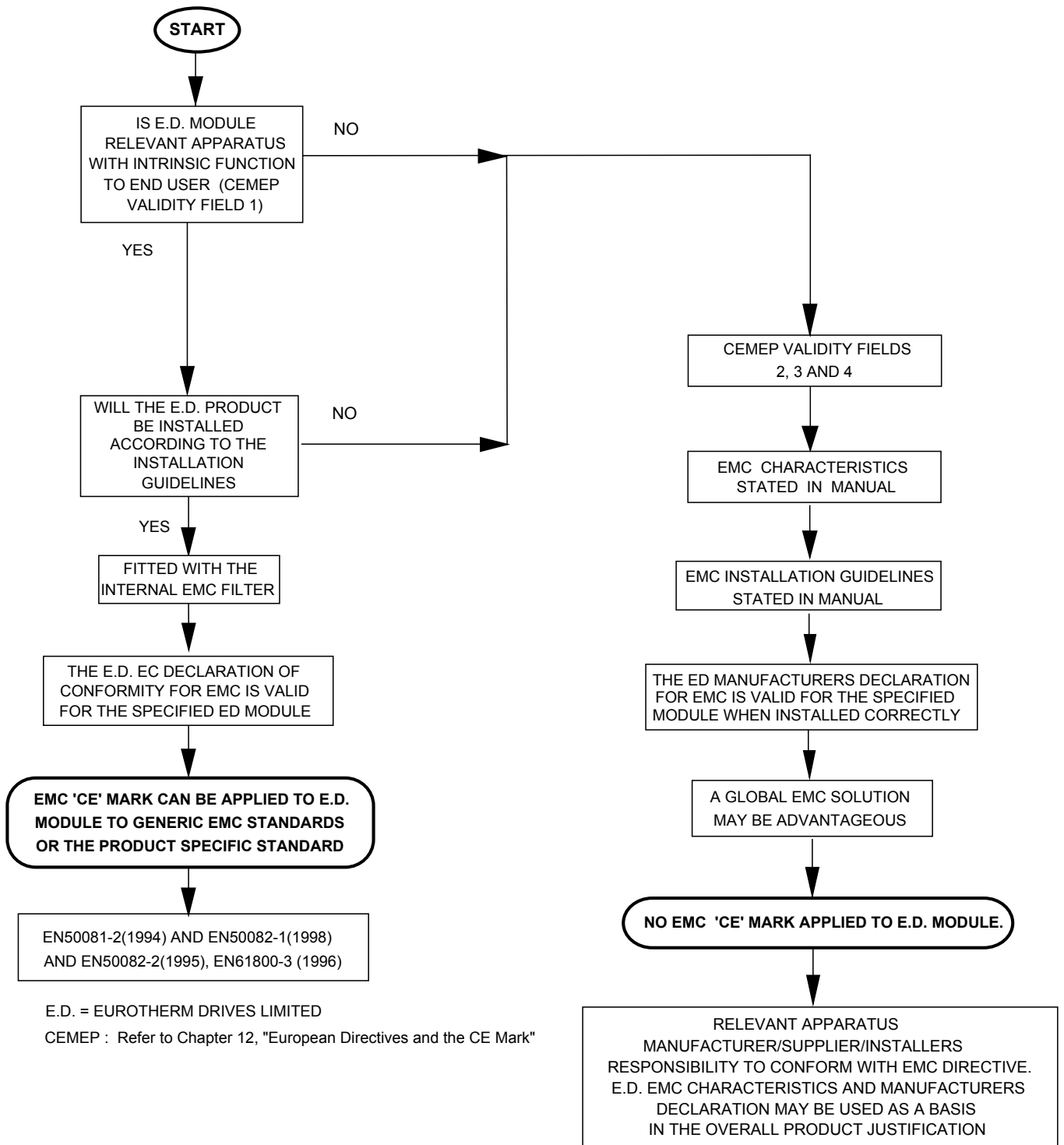

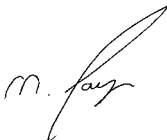



Figure 12-2 Eurotherm EMC 'CE' Mark Validity Chart

Certificates

631				
	<p>EC DECLARATIONS OF CONFORMITY</p> <p>Date CE marked first applied: 07/04/99</p>			
EMC Directive	Low Voltage Directive			
<p>In accordance with the EEC Directive 89/336/EEC and amended by 92/31/EEC and 93/68/EEC, Article 10 and Annex 1, (EMC DIRECTIVE)</p> <p>We Eurotherm Drives Limited, address as below, declare under our sole responsibility that the above Electronic Products when installed and operated with reference to the instructions in the Product Manual (provided with each piece of equipment) is in accordance with the relevant clauses from the following standards:-</p> <p>BSEN50081-2 (1994), BSEN50082-1# (1998), BSEN50082-2# (1995) and BSEN61800-3 (1996).</p>	<p>In accordance with the EEC Directive 73/23/EEC and amended by 93/68/EEC, Article 13 and Annex III, (LOW VOLTAGE DIRECTIVE)</p> <p>We Eurotherm Drives Limited, address as below, declare under our sole responsibility that the above Electronic Products when installed and operated with reference to the instructions in the Product Manual (provided with each piece of equipment), is in accordance with the following standard :-</p> <p>EN50178 (1998)</p>			
MANUFACTURERS DECLARATIONS				
EMC Declaration	Machinery Directive			
<p>We Eurotherm Drives Limited, address as below, declare under our sole responsibility that the above Electronic Products when installed and operated with reference to the instructions in the Product Manual (provided with each piece of equipment) is in accordance with the relevant clauses from the following standards:-</p> <p>BSEN50081-2 (1994), BSEN50082-1# (1998), BSEN50082-2# (1995) and BSEN61800-3 (1996).</p>	<p>The above Electronic Products are components to be incorporated into machinery and may not be operated alone. The complete machinery or installation using this equipment may only be put into service when the safety considerations of the Directive 89/392/EEC are fully adhered to.</p> <p>Particular reference should be made to EN60204-1 (Safety of Machinery - Electrical Equipment of Machines).</p> <p>All instructions, warnings and safety information of the Product Manual must be adhered to.</p>			
 Dr Martin Payn (Conformance Officer)				
<p><i>For information only.</i></p> <p># Compliant with these immunity standards without specified EMC filters.</p>				
<p>EUROTHERM DRIVES LIMITED An Invensys Company</p> <p>NEW COURTWICK LANE, LITTLEHAMPTON, WEST SUSSEX BN17 7RZ</p> <p>TELEPHONE: +44(0)1903 737000 FAX: +44(0)1903 737100</p> <p>Registered Number: 1159876 England. Registered Office: Southdownview Way, Worthing, West Sussex BN14 8NN</p>				
<p>File Name: F:\PRODUCTS\CE\SAFETY\PRODUCTS\631\HP469001.919.doc © 1999 EUROTHERM DRIVES LIMITED</p>				
ISS: A	DATE: 07/04/99	DRN: MP	CHKD:	DRAWING NUMBER: HK469001.919
			TITLE: Declarations of Conformity	SHT 13 OF 1 SHTS

Issued for compliance with the EMC Directive when the unit is used as *relevant apparatus*.

This is provided to aid your justification for EMC compliance when the unit is used as a component.

The drive is CE marked in accordance with the low voltage directive for electrical equipment and appliances in the voltage range when installed correctly.

Since the potential hazards are mainly electrical rather than mechanical, the drive does not fall under the machinery directive. However, we do supply a manufacturer's declaration for when the drive is used(as a component) in machinery.

APPLICATION NOTES

Application advice is available through our Technical Support Department, who can also arrange for on-site assistance if required. Refer to Chapter 8: “Routine Maintenance and Repair” for the address of your local Eurotherm Drives company.

- Always use gold flash relays, or others designed for low current operation (5mA), on all control wiring.

Controlling Synchronous Motors

Synchronous motors can offer economic solutions in applications where tight control of torque, speed, position and high dynamics is required together with the low maintenance characteristics of an ac motor.

The most common types of synchronous ac servo motors are *permanent magnet* types.

In contrast to induction motors, synchronous motors run at synchronous speed whether on full load or no load. Synchronous speed is set by the frequency of the supply applied to the stator. The stator flux is controlled by controlling the current phase vector. This is possible by using a feed-back system which senses the rotor position, e.g. by Resolver.

Using Line Chokes

Line chokes are not required to limit input current to Eurotherm Drives Servo drives.

Line chokes may be used to reduce the harmonic content of the supply current where this a particular requirement of the application or where greater protection from mains borne transients is required.

Using Output Contactors

The use of output contactors is not recommended. However, if you are required to use output contactors, we recommend that this type of operation is limited to emergency use only or in a system where the drive can be inhibited before closing or opening this contactor.

Using Motor Chokes

Installations with long motor cable runs in the range of 50m may suffer from nuisance overcurrent trips. This is due to the capacitance of the cable causing current spikes to be drawn from the servo drive output. A choke may be fitted in the servo drive output which limits the capacitive current.

Motor chokes may also be used to increase the value of load inductance in those cases where the motor inductance does not reach the required minimum value.

Refer to Eurotherm Drives for more information.

Dynamic Braking

The energy of a moving system flows back into the drive while decelerating. The DC-Bus capacitors are able to take a small value. The remainder is converted to heat by a high power resistor switched across the DC link.

Switching on and off of this brake resistor depends on the DC-Bus voltage.

The load of the resistor is simulated and supervised electronically (EASYRIDER .

Peak power (Pmax) and continuous power (Pd) ratings have to be sufficient to meet the requirements of the application.

Example Brake Resistor Calculation

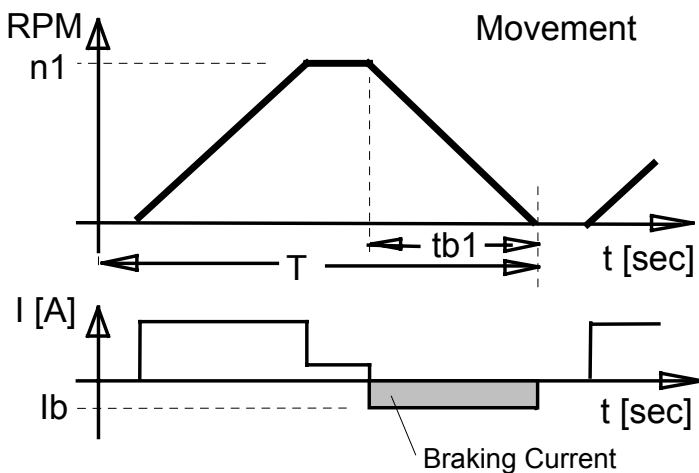

Data	Example Values
Speed at Brake-Start	n1 = 3000 RPM
Braking Time	tb1 = 0.1 seconds
Cycle-Time	T = 2.0 seconds
Total Inertia	J = 0.0005 kgm ²
Braking-Current	Ib = 3.2A
Motor-Resistance	Rph = 3.6 Ohm
Cable-Resistance	RL = 0.3 Ohm

STEP 1 : Calculating actual brake power (an approximation - capacitor load, friction and drive losses are neglected)	
Example (values see above)	Calculation
$P_{kin} = 0.0055 * 0.0005 * 3000^2 / 0.1$ $P_{kin} = 247W$	Power of Motion: $P_{kin} = 0.0055 * J * n1^2 / tb1$ [W]
$P_{vmot} = 3.2^2 * (3.6 + 0.3)$ $P_{vmot} = 40W$	Motor Losses: $P_{vmot} = Ib^2 * (Ri + RL)$ [W]
$Pd = 0.9 * (247 - 40) * 0.1 / 2$ $Pd = 9.3W$	Continuous Power: $Pd = 0.9 * (P_{kin} - P_{vmot}) * tb1 / T$ [W]
$P_{max} = (1.8 * 247) - 40$ $P_{max} = 405W$	Peak Power: $P_{max} = (1.8 * P_{kin}) - P_{vmot}$ [W]
<i>units used:</i> J total inertia [kgm ²] n1 speed at Brake-Start [RPM] tb1 braking time [Sec] T cycle time [Sec] Ib brake-current [A] Rph resistance of motor (between terminals) [Ω] RL line resistance of motor cable [Ω]	

STEP 2: To determine if a brake resistor is required	
Example	Calculation
Drive model 631/004 selected	Do you require an external brake-resistor?
<p>Drive Data from Chapter 11 Nominal Power internal: 8W Maximum Power internal: 352W</p> <p>From Step 1 calculation Continuous Power: 9.3W Maximum Power: 405W</p> <p>Result: An external braking resistor is required in this case. Refer to the Chapter 9: "Accessories"</p>	<p>In case of insufficient capability of the internal brake resistor, an external resistor must be connected. (Terminals DBR1, DBR2)</p>

IMPORTANT: Only the approved resistors listed in Chapter 9: "Accessories" must be used with the 631 servo drive.

Derating of Output Voltage

Due to the line-ripple of DC Bus, the rate of usable output voltage is derated as follows. This deration affects the maximum achievable speed of the applied motor.

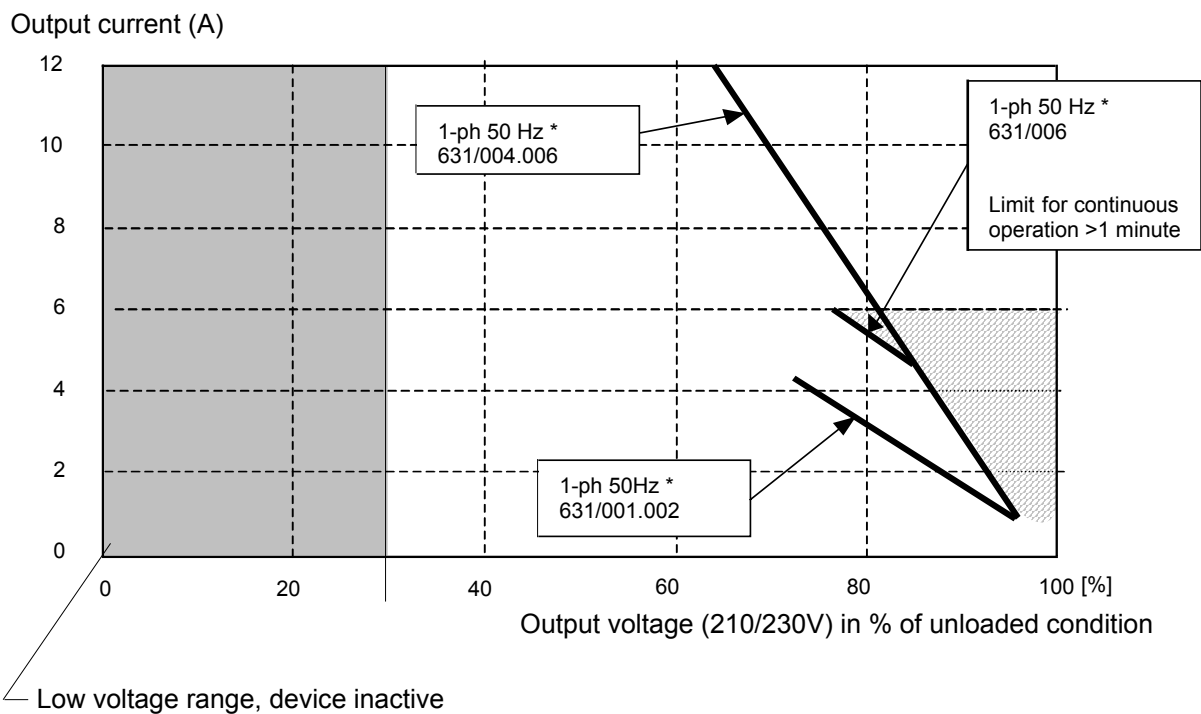

Derating of Servo Drive Output Voltage

* The specified reductions refer to 50Hz, the most unfavourable operating state.

13-4 Application Notes

Approximate calculation of required motor terminal voltage for a specified motor speed (up to 3000rpm)

$$U_{kl} = 1,2 (EMC * n / 1000 + I * (R_{ph} + R_L)) \quad (\text{Volts})$$

where:

U _{kl}	Required motor voltage (V rms)
EMF	Back-EMF of motor (V rms)/1000 rpm
R _{ph}	Resistance of motor (between terminals) (Ω)
R _L	Line resistance of motor cable (Ω)
I	Motor-current (A rms)

FUNCTIONAL BLOCK DIAGRAM

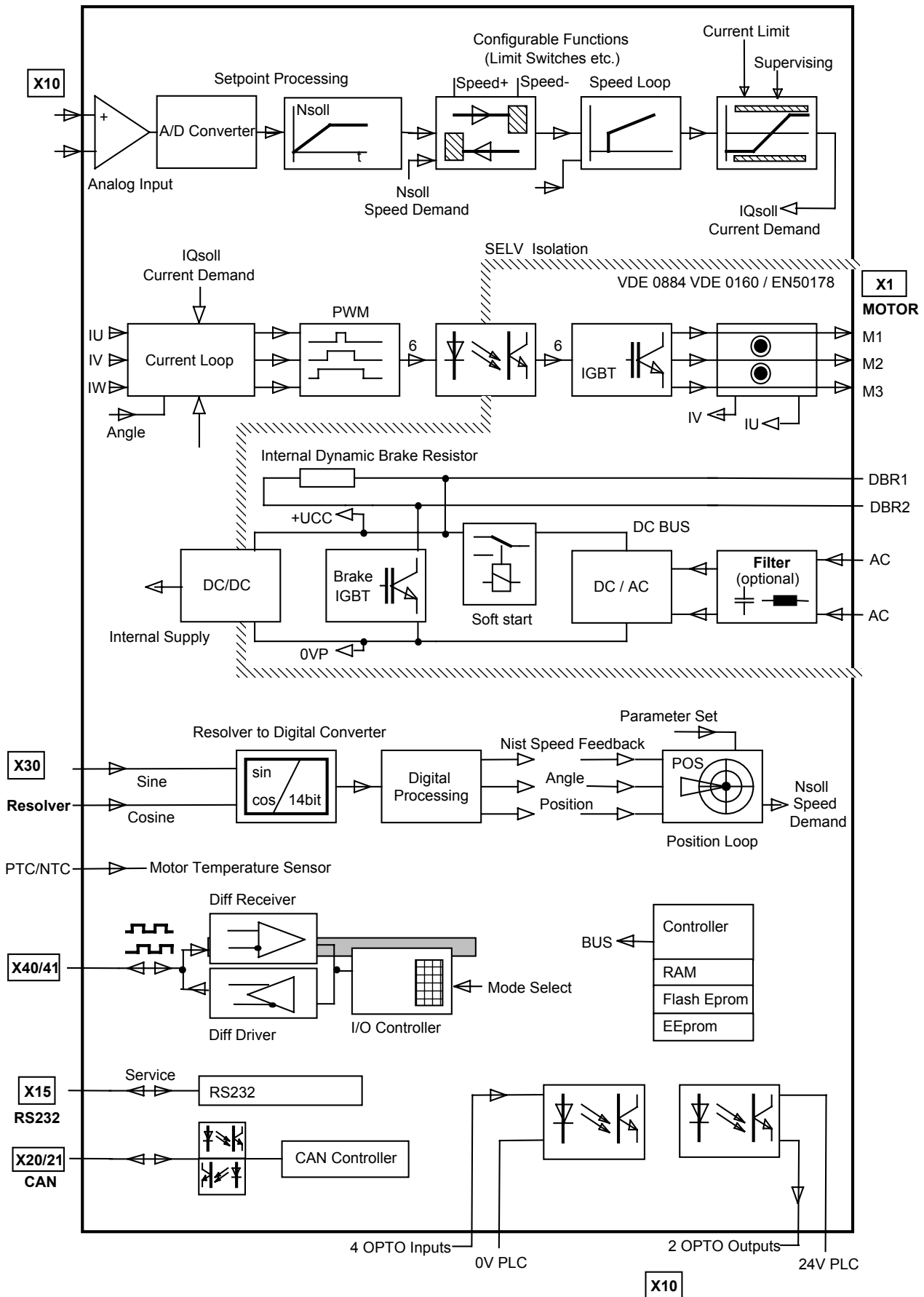

Modification Record

Version	Modification	Chapter	Date	Name	shorthand expression	Comment
Preliminary V1	initial		02.10.98	PL		
V02.47PL98	überarbeitet	12	16.11.98	SA		
V03.16PL99	überarbeitet	alle / <i>all</i>	22.04.99	PL/GV/ST		
V04.21PL99	neues Thema für Kapitel 3	3	25.05.99	PL/ST		
	neues Kapitel	3.4				
	Textänderung	5.6				
	neue BIAS-Befehle	12.5				
	neues Kapitel	12.6				
V0500	German Layout	all	15.12.00	Norbert Dreilich	DL	Orginal from England